

**FEATURES**

**Fixed gain of 15 dB**

**Operation up to 6 GHz**

**Input/output internally matched to 50 Ω**

**Integrated bias control circuit**

**Output IP<sub>3</sub>**

**44 dBm at 500 MHz**

**40 dBm at 900 MHz**

**Output 1 dB compression: 19.7 dBm at 900 MHz**

**Noise figure of 3.5 dB at 900 MHz**

**Single 5 V power supply**

**Small footprint 8-lead LFCSP**

**Pin compatible with 20 dB gain [ADL5542](#)**

**1 kV ESD (Class 1C)**

**GENERAL DESCRIPTION**

The [ADL5541](#) is a broadband 15 dB linear amplifier that operates at frequencies up to 6 GHz. The device can be used in a wide variety of CATV, cellular, and instrumentation equipment.

The [ADL5541](#) provides a gain of 15 dB, which is stable over frequency, temperature, power supply, and from device to device. The device is internally matched to 50 Ω with an input return loss of 10 dB or better up to 6 GHz. Only input/output ac coupling capacitors, power supply decoupling capacitors, and an external inductor are required for operation.

**FUNCTIONAL BLOCK DIAGRAM**

Figure 1.

The [ADL5541](#) is fabricated on an InGaP HBT process and has an ESD rating of 1 kV (Class 1C). The device is packaged in a 3 mm × 3 mm LFCSP that uses an exposed paddle for excellent thermal impedance.

The [ADL5541](#) consumes 90 mA on a single 5 V supply and is fully specified for operation from -40°C to +85°C.

A fully populated RoHS-compliant evaluation board is available.

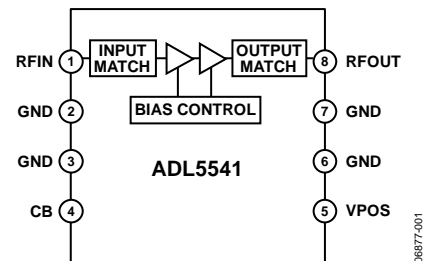
The [ADL5542](#) is a companion part that offers a gain of 20 dB in a pin-compatible package.

## TABLE OF CONTENTS

|  |   |  |    |
|--|---|--|----|
| Features .....                                   | 1 | Typical Performance Characteristics .....      | 8  |
| Functional Block Diagram .....                   | 1 | Operating to 20 MHz.....                       | 10 |
| General Description .....                        | 1 | Basic Connections .....                        | 11 |
| Revision History .....                           | 2 | Soldering Information and Recommended PCB Land |    |
| Specifications.....                              | 3 | Pattern.....                                   | 11 |
| Typical Scattering Parameters.....               | 5 | Evaluation Board .....                         | 12 |
| Absolute Maximum Ratings.....                    | 6 | Outline Dimensions .....                       | 13 |
| ESD Caution.....                                 | 6 | Ordering Guide .....                           | 13 |
| Pin Configuration and Function Descriptions..... | 7 |  |    |

## REVISION HISTORY

### 2/15—Rev. A to Rev. B

|   |    |
|---|----|
| Changed Frequency Range from 50 MHz to 6000 MHz to<br>20 MHz to 6000 MHz (Throughout) ..... | 1  |
| Changes to Table 1 .....  | 3  |
| Added Figure 14 to Figure 19; Renumbered Sequentially .....                                 | 10 |
| Changes to Basic Connections Section and Table 5; Added<br>Figure 21 and Figure 22 .....    | 11 |
| Updated Outline Dimensions .....  | 13 |
| Changes to Ordering Guide .....   | 13 |

### 11/13—Rev. 0 to Rev. A

|  |    |
|--|----|
| Changes to Figure 2.....                               | 7  |
| Added Figure 13, Renumbered Sequentially .....         | 9  |
| Added Exposed Pad Notation to Outline Dimensions ..... | 12 |

### 7/07—Revision 0: Initial Version

## SPECIFICATIONS

VPOS = 5 V and T<sub>A</sub> = 25°C, unless otherwise noted.

Table 1.

| Parameter                             | Test Conditions/Comments                                      | Min  | Typ   | Max  | Unit |
|---------------------------------------|---|------|-------|------|------|
| <b>OVERALL FUNCTION</b>               |   |      |       |      |      |
| Frequency Range                       |   | 20   |       | 6000 | MHz  |
| Gain (S <sub>21</sub> )               | 900 MHz   |      | 15.2  |      | dB   |
| Input Return Loss (S <sub>11</sub> )  | Frequency 500 MHz to 5 GHz                                    |      | -12   |      | dB   |
| Output Return Loss (S <sub>22</sub> ) | Frequency 500 MHz to 5 GHz                                    |      | -10   |      | dB   |
| Reverse Isolation (S <sub>12</sub> )  |   |      | -19   |      | dB   |
| <b>FREQUENCY = 20 MHz</b>             |   |      |       |      |      |
| Gain                                  |   |      | 17.6  |      | dB   |
| Output 1 dB Compression Point         |   |      | 18.3  |      | dBm  |
| Output Third-Order Intercept          | Δf = 1 MHz, output power (P <sub>OUT</sub> ) = 0 dBm per tone |      | 38    |      | dBm  |
| Noise Figure                          |   |      | 3.3   |      | dB   |
| <b>FREQUENCY = 100 MHz</b>            |   |      |       |      |      |
| Gain                                  |   |      | 15.7  |      | dB   |
| Output 1 dB Compression Point         |   |      | 19    |      | dBm  |
| Output Third-Order Intercept          | Δf = 1 MHz, output power (P <sub>OUT</sub> ) = 0 dBm per tone |      | 37    |      | dBm  |
| Noise Figure                          |   |      | 3.9   |      | dB   |
| <b>FREQUENCY = 500 MHz</b>            |   |      |       |      |      |
| Gain                                  |   | 14.7 | 15.1  | 15.5 | dB   |
| vs. Frequency                         | ±50 MHz   |      | ±0.15 |      | dB   |
| vs. Temperature                       | -40°C ≤ T <sub>A</sub> ≤ +85°C                                |      | ±0.1  |      | dB   |
| vs. Supply                            | 4.75 V to 5.25 V  |      | ±0.01 |      | dB   |
| Output 1 dB Compression Point         |   |      | 19.9  |      | dBm  |
| Output Third-Order Intercept          | Δf = 1 MHz, output power (P <sub>OUT</sub> ) = 3 dBm per tone |      | 44    |      | dBm  |
| Noise Figure                          |   |      | 3.5   | 3.7  | dB   |
| <b>FREQUENCY = 900 MHz</b>            |   |      |       |      |      |
| Gain                                  |   | 14.9 | 15.2  | 15.4 | dB   |
| vs. Frequency                         | ±50 MHz   |      | ±0.03 |      | dB   |
| vs. Temperature                       | -40°C ≤ T <sub>A</sub> ≤ +85°C                                |      | ±0.15 |      | dB   |
| vs. Supply                            | 4.75 V to 5.25 V  |      | ±0.01 |      | dB   |
| Output 1 dB Compression Point         |   |      | 19.7  |      | dBm  |
| Output Third-Order Intercept          | Δf = 1 MHz, output power (P <sub>OUT</sub> ) = 0 dBm per tone |      | 40.8  |      | dBm  |
| Noise Figure                          |   |      | 3.5   | 3.7  | dB   |
| <b>FREQUENCY = 2000 MHz</b>           |   |      |       |      |      |
| Gain                                  |   | 13.9 | 14.7  | 15.4 | dB   |
| vs. Frequency                         | ±50 MHz   |      | ±0.03 |      | dB   |
| vs. Temperature                       | -40°C ≤ T <sub>A</sub> ≤ +85°C                                |      | ±0.17 |      | dB   |
| vs. Supply                            | 4.75 V to 5.25 V  |      | ±0.01 |      | dB   |
| Output 1 dB Compression Point         |   |      | 16.3  |      | dBm  |
| Output Third-Order Intercept          | Δf = 1 MHz, output power (P <sub>OUT</sub> ) = 0 dBm per tone |      | 39.2  |      | dBm  |
| Noise Figure                          |   |      | 3.8   | 4.0  | dB   |
| <b>FREQUENCY = 2400 MHz</b>           |   |      |       |      |      |
| Gain                                  |   | 13.9 | 14.5  | 15.1 | dB   |
| vs. Frequency                         | ±50 MHz   |      | ±0.03 |      | dB   |
| vs. Temperature                       | -40°C ≤ T <sub>A</sub> ≤ +85°C                                |      | ±0.19 |      | dB   |
| vs. Supply                            | 4.75 V to 5.25 V  |      | ±0.02 |      | dB   |
| Output 1 dB Compression Point         |   |      | 14.9  |      | dBm  |
| Output Third-Order Intercept          | Δf = 1 MHz, output power (P <sub>OUT</sub> ) = 0 dBm per tone |      | 38.6  |      | dBm  |
| Noise Figure                          |   |      | 4.0   | 4.2  | dB   |

| Parameter                     | Test Conditions/Comments  | Min  | Typ        | Max  | Unit |
|-------------------------------|---|------|------------|------|------|
| FREQUENCY = 3500 MHz          |   |      |            |      |      |
| Gain                          |   | 13.6 | 14.3       | 14.9 | dB   |
| vs. Frequency                 | $\pm 50$ MHz  |      | $\pm 0.03$ |      | dB   |
| vs. Temperature               | $-40^{\circ}\text{C} \leq T_A \leq +85^{\circ}\text{C}$         |      | $\pm 0.19$ |      | dB   |
| vs. Supply                    | 4.75 V to 5.25 V  |      | $\pm 0.02$ |      | dB   |
| Output 1 dB Compression Point |   |      | 12.1       |      | dBm  |
| Output Third-Order Intercept  | $\Delta f = 1$ MHz, output power ( $P_{OUT}$ ) = 0 dBm per tone |      | 30.7       |      | dBm  |
| Noise Figure                  |   | 4.2  |            | 4.5  | dB   |
| FREQUENCY = 5800 MHz          |   |      |            |      |      |
| Gain                          |   | 9.1  | 11.2       | 13.5 | dB   |
| vs. Frequency                 | $\pm 50$ MHz  |      | $\pm 0.15$ |      | dB   |
| vs. Temperature               | $-40^{\circ}\text{C} \leq T_A \leq +85^{\circ}\text{C}$         |      | $\pm 0.9$  |      | dB   |
| vs. Supply                    | 4.75 V to 5.25 V  |      | $\pm 0.02$ |      | dB   |
| Output 1 dB Compression Point |   |      | 5.8        |      | dBm  |
| Output Third-Order Intercept  | $\Delta f = 1$ MHz, output power ( $P_{OUT}$ ) = 0 dBm per tone |      | 21.9       |      | dBm  |
| Noise Figure                  |   | 6.0  |            | 7.0  | dB   |
| POWER INTERFACE               |   |      |            |      |      |
| Supply Voltage (VPOS)         | Pin VPOS  | 4.5  | 5          | 5.5  | V    |
| Supply Current                |   |      | 90         | 100  | mA   |
| vs. Temperature               | $-40^{\circ}\text{C} \leq T_A \leq +85^{\circ}\text{C}$         |      | $\pm 12$   |      | mA   |
| Power Dissipation             | VPOS = 5 V  |      | 0.5        |      | W    |

**TYPICAL SCATTERING PARAMETERS**

VPOS = 5 V and T<sub>A</sub> = 25°C, the effects of the test fixture have been de-embedded up to the pins of the device.

Table 2.

| Freq. (MHz) | S11            |           | S21            |           | S12            |           | S22            |           |
|-------------|----------------|-----------|----------------|-----------|----------------|-----------|----------------|-----------|
|             | Magnitude (dB) | Angle (°) | Magnitude (dB) | Angle (°) | Magnitude (dB) | Angle (°) | Magnitude (dB) | Angle (°) |
| 50          | -18.11         | -134.53   | 16.29          | +166.36   | -19.15         | +3.84     | -17.89         | -134.08   |
| 100         | -20.84         | -161.29   | 15.93          | +168.53   | -18.82         | +2.26     | -22.24         | -155.22   |
| 500         | -27.69         | +115.36   | 15.58          | +154.53   | -18.70         | -13.59    | -24.96         | +176.64   |
| 900         | -27.48         | +101.79   | 15.52          | +136.22   | -18.70         | -26.33    | -22.38         | +173.92   |
| 1000        | -26.87         | +91.91    | 15.56          | +131.64   | -18.64         | -29.43    | -23.15         | +174.28   |
| 1500        | -29.18         | -107.74   | 15.50          | +108.03   | -18.64         | -44.69    | -19.35         | +167.80   |
| 2000        | -17.88         | -153.68   | 15.51          | +84.72    | -18.43         | -60.42    | -14.13         | +176.19   |
| 2500        | -9.87          | +169.30   | 15.57          | +59.74    | -18.32         | -75.48    | -9.89          | +161.55   |
| 3000        | -7.92          | +142.75   | 15.49          | +35.05    | -17.93         | -92.29    | -8.69          | +138.18   |
| 3500        | -7.74          | +117.57   | 15.21          | +9.15     | -18.14         | -110.62   | -11.02         | +100.39   |
| 4000        | -10.85         | +116.84   | 14.82          | -16.13    | -18.11         | -125.08   | -15.70         | +6.37     |
| 4500        | -13.25         | +136.93   | 15.23          | -41.75    | -17.54         | -142.99   | -7.83          | -80.59    |
| 5000        | -13.97         | +143.02   | 14.56          | -68.15    | -17.64         | -161.24   | -6.87          | -112.39   |
| 5500        | -13.68         | -121.08   | 13.89          | -96.10    | -17.47         | +178.77   | -11.66         | -102.32   |
| 6000        | -4.52          | -138.62   | 12.07          | -123.56   | -18.61         | +157.35   | -7.66          | -54.40    |

## ABSOLUTE MAXIMUM RATINGS

Table 3.

| Parameter                                    | Rating          |
|--|-----------------|
| Supply Voltage, VPOS                         | 6.5 V           |
| Input Power (re: 50 $\Omega$ )               | 10 dBm          |
| Internal Power Dissipation (Paddle Soldered) | 650 mW          |
| $\theta_{jC}$ (Junction to Paddle)           | 28.5°C/W        |
| Maximum Junction Temperature                 | 150°C           |
| Operating Temperature Range                  | -40°C to +85°C  |
| Storage Temperature Range                    | -65°C to +150°C |

Stresses at or above those listed under Absolute Maximum Ratings may cause permanent damage to the product. This is a stress rating only; functional operation of the product at these or any other conditions above those indicated in the operational section of this specification is not implied. Operation beyond the maximum operating conditions for extended periods may affect product reliability.

### ESD CAUTION



**ESD (electrostatic discharge) sensitive device.** Charged devices and circuit boards can discharge without detection. Although this product features patented or proprietary protection circuitry, damage may occur on devices subjected to high energy ESD. Therefore, proper ESD precautions should be taken to avoid performance degradation or loss of functionality.

## PIN CONFIGURATION AND FUNCTION DESCRIPTIONS

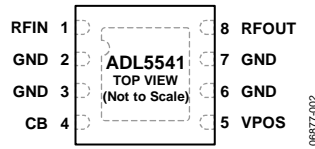

### NOTES

- EXPOSED PADDLE. INTERNALLY CONNECTED TO GND. SOLDER TO A LOW IMPEDANCE GROUND PLANE.

Figure 2. Pin Configuration

Table 4. Pin Function Descriptions

| Pin No.        | Mnemonic | Description  |
|----------------|----------|--|
| 1              | RFIN     | RF Input. Requires a dc blocking capacitor.  |
| 2, 3, 6, 7     | GND      | Ground. Connect these pins to a low impedance ground plane.  |
| 4              | CB       | Low Frequency Bypass. A 1 $\mu$ F capacitor should be connected between this pin and ground.   |
| 5              | VPOS     | Power Supply for Bias Controller. Connect directly to external power supply.   |
| 8              | RFOUT    | RF Output and Supply Voltage. DC bias is provided to this pin through an inductor that is tied to the external power supply. RF path requires a dc blocking capacitor. |
| Exposed Paddle |          | Exposed Paddle. Internally connected to GND. Solder to a low impedance ground plane.   |

### TYPICAL PERFORMANCE CHARACTERISTICS

VPOS = 5 V and  $T_A = 25^\circ\text{C}$ , unless otherwise noted.  $C1 = 33\text{ pF}$ ,  $C2 = 33\text{ pF}$ ,  $L1 = 47\text{ nH}$ .

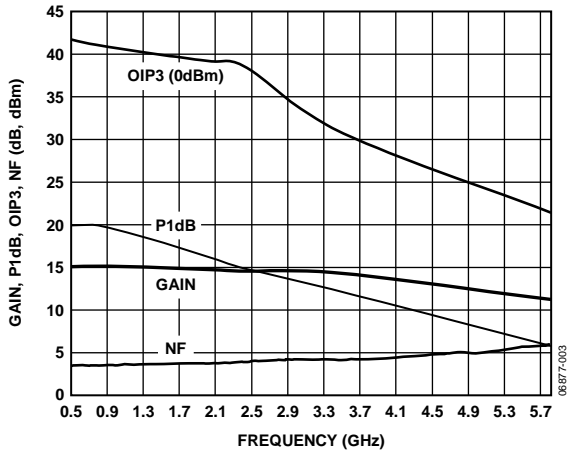

Figure 3. Gain, P1dB, OIP3, and Noise Figure vs. Frequency

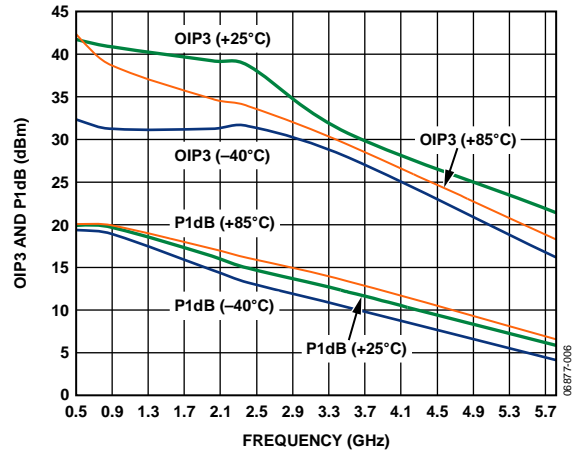

Figure 6. OIP3 and P1dB vs. Frequency and Temperature

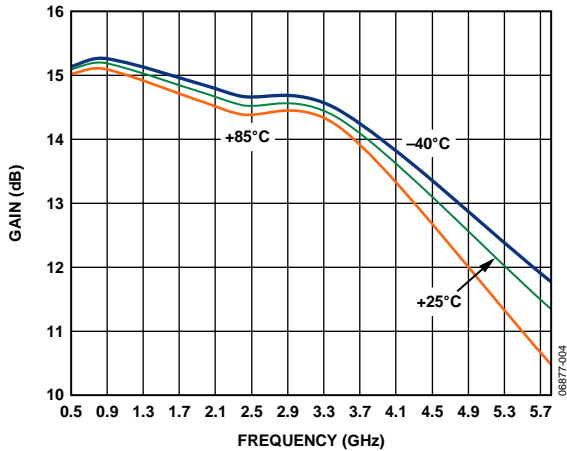

Figure 4. Gain vs. Frequency and Temperature

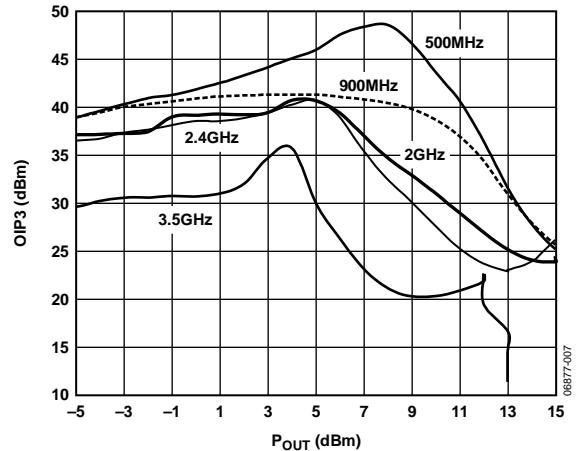

Figure 7. OIP3 vs. Output Power ( $P_{out}$ ) and Frequency

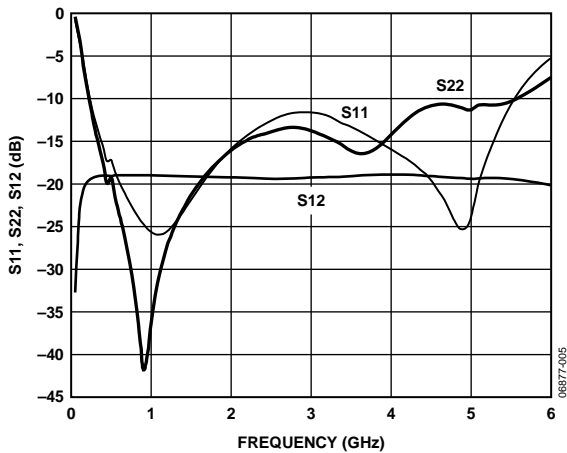

Figure 5. Input Return Loss (S11), Output Return Loss (S22), and Reverse Isolation (S12) vs. Frequency

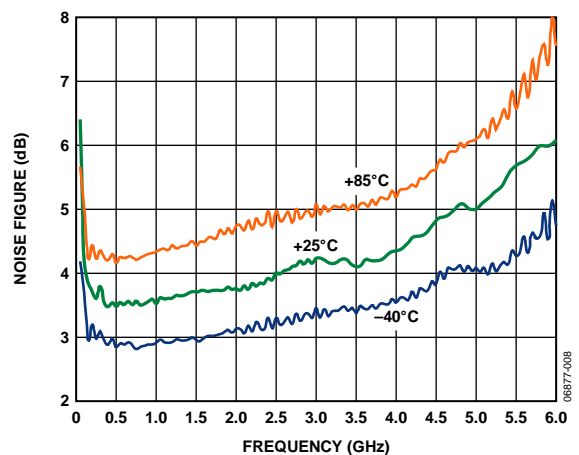

Figure 8. Noise Figure vs. Frequency and Temperature



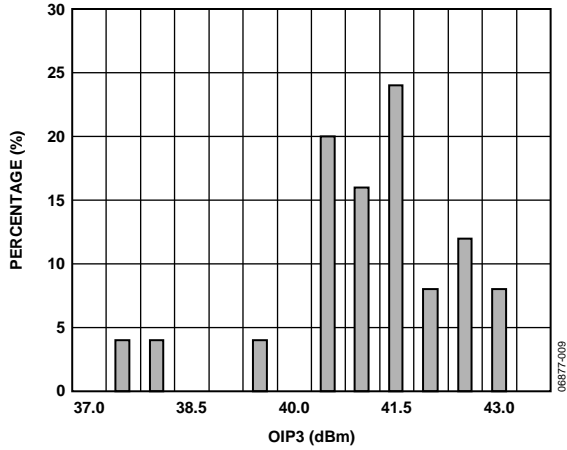

Figure 9. OIP3 Distribution at 900 MHz

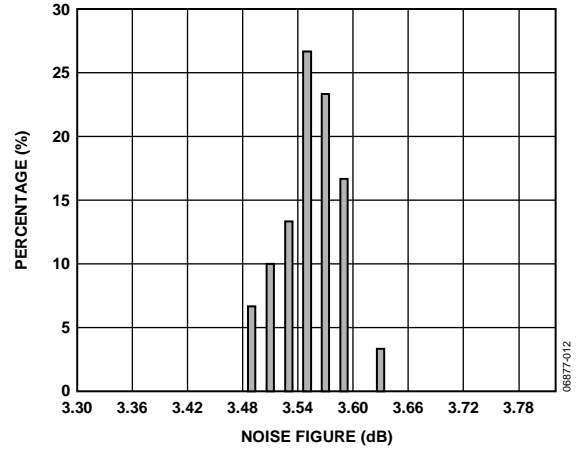

Figure 12. Noise Figure Distribution at 900 MHz

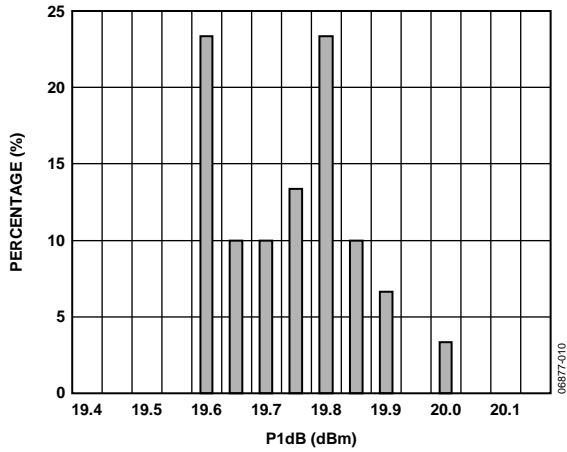

Figure 10. P1dB Distribution at 900 MHz

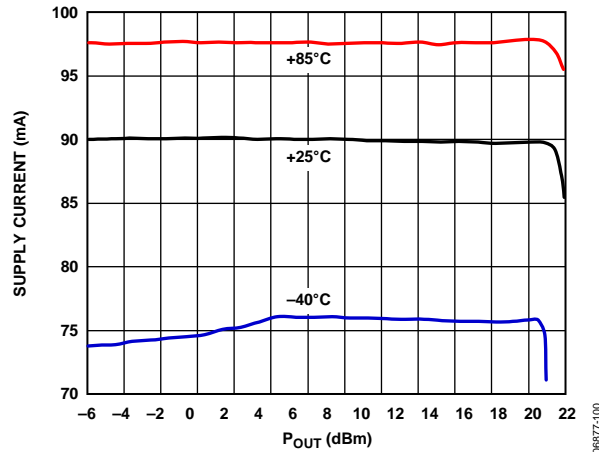

Figure 13. Supply Current vs.  $P_{OUT}$  and Temperature

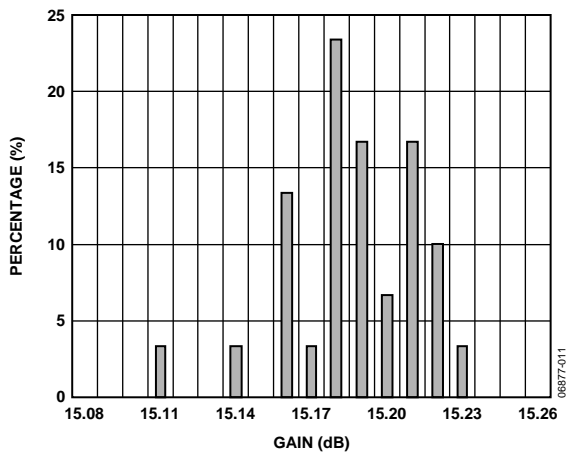

Figure 11. Gain Distribution at 900 MHz

**OPERATING TO 20 MHz**

VPOS = 5 V and  $T_A = 25^\circ\text{C}$ , unless otherwise noted.  $C1 = 0.1 \mu\text{F}$ ,  $C2 = 0.1 \mu\text{F}$ ,  $L1 = 1 \mu\text{H}$ .

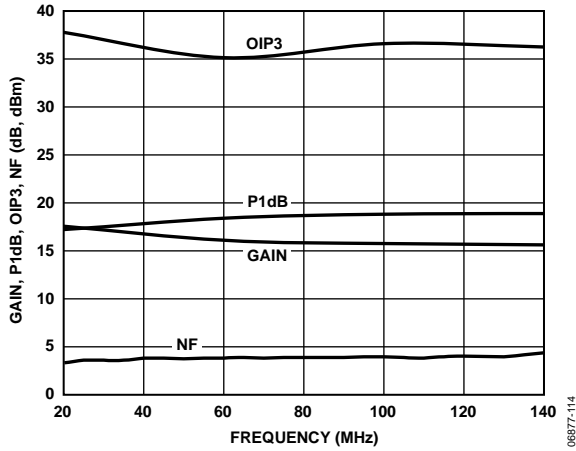

Figure 14. Gain, P1dB, OIP3, and Noise Figure vs. Frequency

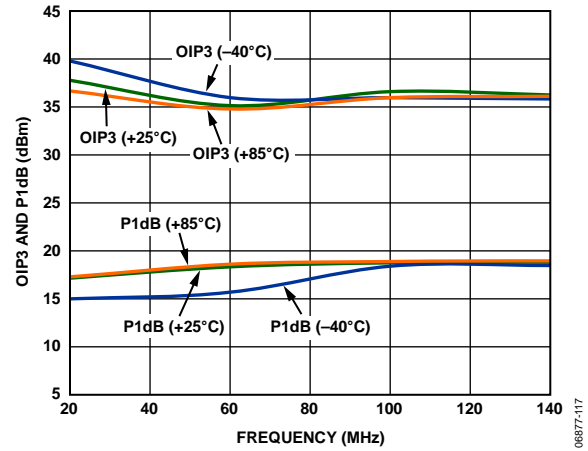

Figure 17. OIP3 and P1dB vs. Frequency and Temperature

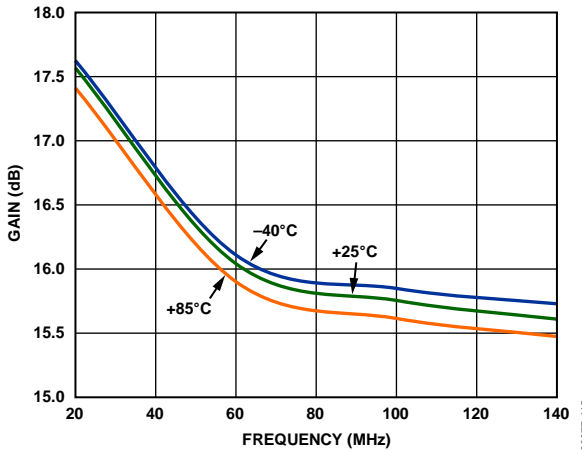

Figure 15. Gain vs. Frequency and Temperature

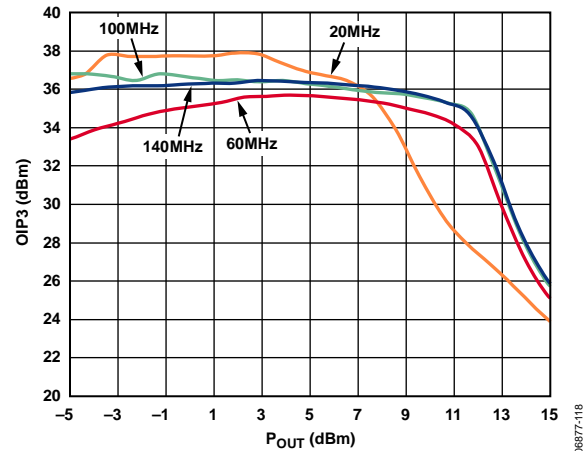

Figure 18. OIP3 vs. Output Power ( $P_{out}$ ) and Frequency

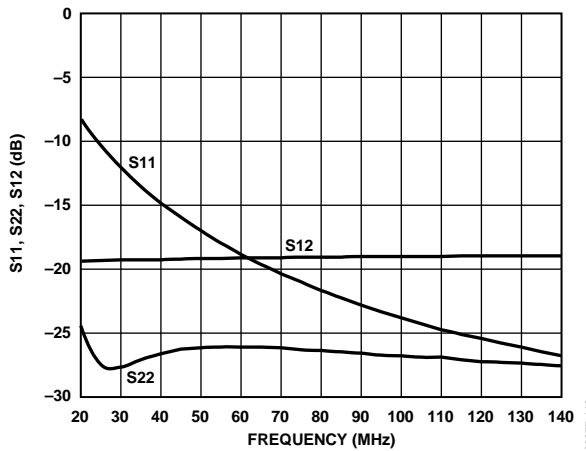

Figure 16. Input Return Loss ( $S_{11}$ ), Output Return Loss ( $S_{22}$ ), and Reverse Isolation ( $S_{12}$ ) vs. Frequency

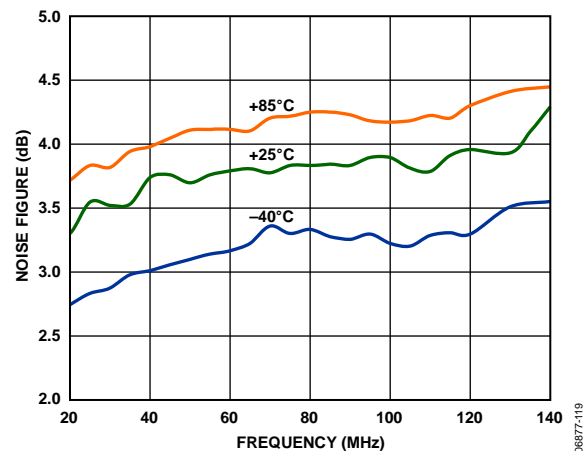

Figure 19. Noise Figure vs. Frequency and Temperature

### BASIC CONNECTIONS

The basic connections for operating the ADL5541 are shown in Figure 20. Recommended components are listed in Table 5. The input and output should be ac-coupled with appropriately sized capacitors (device characterization was performed with 33 pF capacitors). A 5 V dc bias is supplied to the amplifier via GND (Pin 6) and through a biasing inductor connected to RFOUT (Pin 8). The bias voltage should be decoupled using a 1 μF capacitor, a 1.2 nF capacitor, and two 68 pF capacitors.

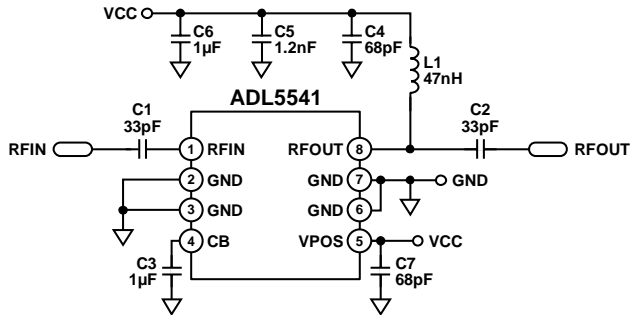

Figure 20. Basic Connections

For operation below 500 MHz, a larger biasing choke and ac coupling capacitors are necessary (see Table 5). Figure 21 shows input return loss, output return loss, and gain for frequencies between 200 MHz and 500 MHz. The noise figure performance for operation from 200 MHz to 500 MHz is shown in Figure 22.

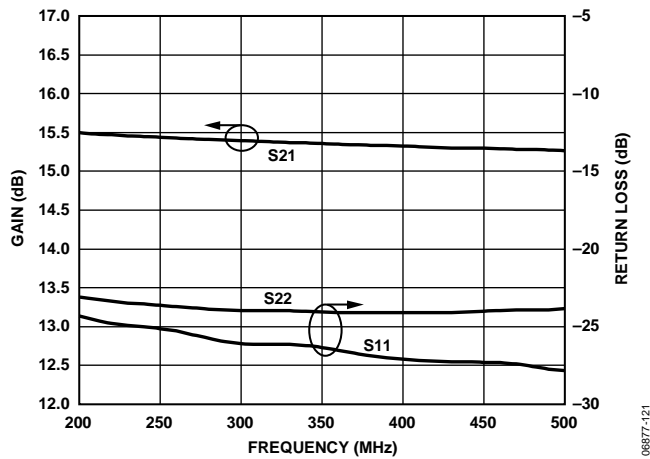

Figure 21. Input Return Loss (S11), Output Return Loss (S22), and Gain (S21) vs. Frequency

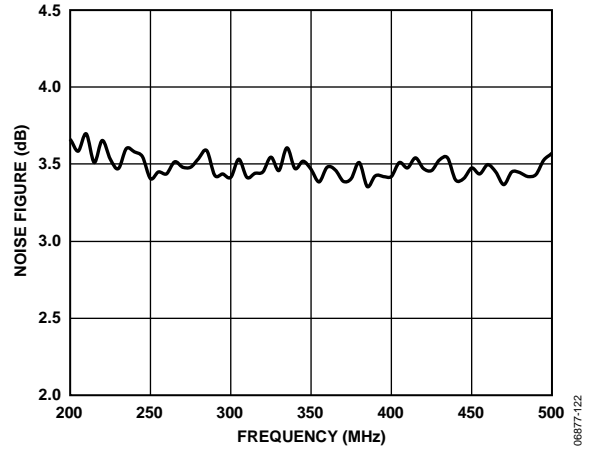

Figure 22. Noise Figure vs. Frequency from 200 MHz to 500 MHz

### SOLDERING INFORMATION AND RECOMMENDED PCB LAND PATTERN

Figure 23 shows the recommended land pattern for the ADL5541. To minimize thermal impedance, the exposed paddle on the package underside should be soldered down to a ground plane along with Pin 2, Pin 3, Pin 6, and Pin 7. If multiple ground layers exist, they should be stitched together using vias (a minimum of five vias is recommended). For more information on land pattern design and layout, refer to Application Note AN-772, A Design and Manufacturing Guide for the Lead Frame Chip Scale Package (LFCSP).

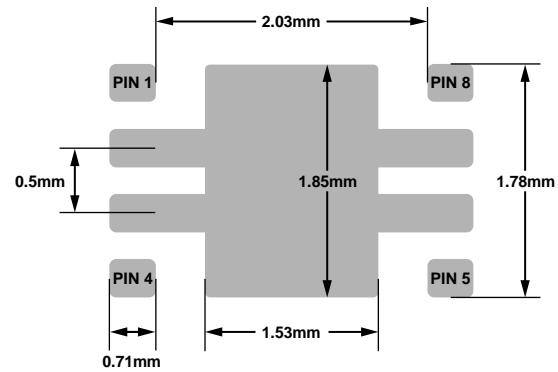

Figure 23. Recommended Land Pattern

Table 5. Recommended Components for Basic Connections

| Frequency           | C1     | C2     | C3   | L1   | C4    | C5     | C6   | C7    |
|---------------------|--------|--------|------|--|-------|--------|------|-------|
| 20 MHz to 200 MHz   | 0.1 μF | 0.1 μF | 1 μF | 1 μH (Coilcraft 0805LS-102XJL_ or equivalent)  | 68 pF | 1.2 nF | 1 μF | 68 pF |
| 200 MHz to 500 MHz  | 0.1 μF | 0.1 μF | 1 μF | 470 nH (Coilcraft 0603LS-471-NX or equivalent) | 68 pF | 1.2 nF | 1 μF | 68 pF |
| 500 MHz to 6000 MHz | 33 pF  | 33 pF  | 1 μF | 47 nH (Coilcraft 0603CS-47-NX or equivalent)   | 68 pF | 1.2 nF | 1 μF | 68 pF |

### EVALUATION BOARD

Figure 26 shows the schematic for the ADL5541 evaluation board. The board is powered by a single 5 V supply.

The components used on the board are listed in Table 6. Power can be applied to the board through clip-on leads (VCC and GND) or through a 2-pin header (W1).

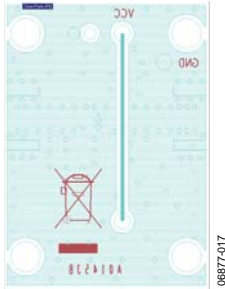

Figure 24. Evaluation Board Layout (Bottom)

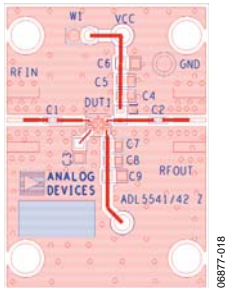

Figure 25. Evaluation Board Layout (Top)

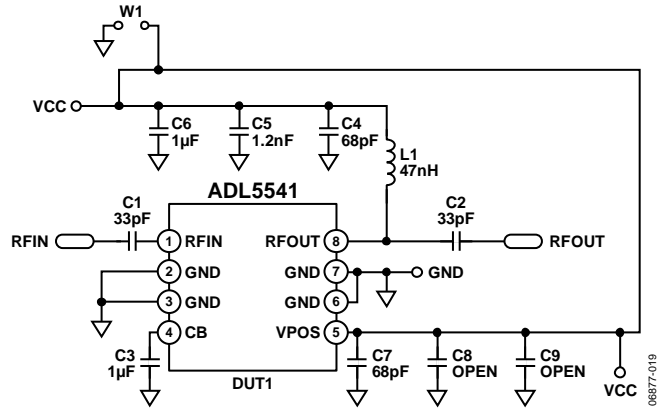
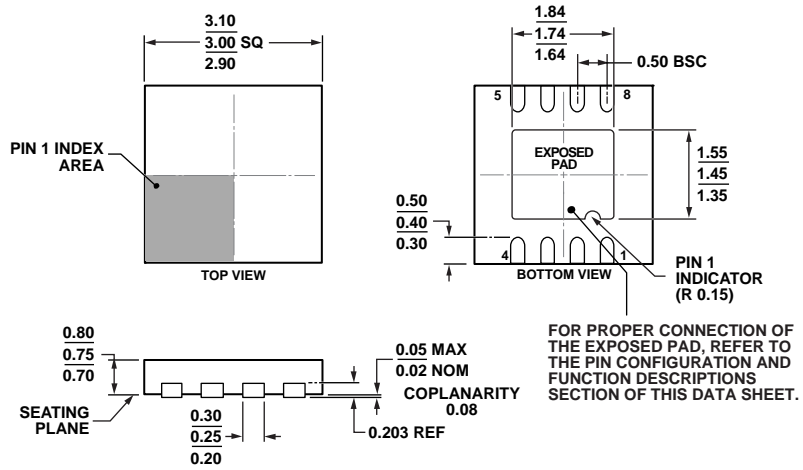

Figure 26. Evaluation Board Schematic

Table 6. Evaluation Board Configuration

| Component              | Function   | Default Value   |
|------------------------|--|---|
| DUT1                   | Gain block   | ADL5541   |
| C1, C2                 | AC coupling capacitors                                     | 33 pF, 0402   |
| C3                     | Low frequency bypass capacitor                             | 1 μF, 0805  |
| C4, C5, C6, C7, C8, C9 | Power supply decoupling capacitors                         | C4 and C7 = 68 pF, 0603<br>C5 = 1.2 nF, 0603<br>C6 = 1 μF, 0805<br>C8 and C9 = open |
| L1                     | DC bias inductor   | 47 nH, 0603 (Coilcraft 0603CS-47-NX or equivalent)                                  |
| VCC and GND            | Clip-on terminals for power supply                         |   |
| W1                     | 2-pin header for connection of ground and supply via cable |   |

# OUTLINE DIMENSIONS



COMPLIANT TO JEDEC STANDARDS MO-229-WEED

Figure 27. 8-Lead Lead Frame Chip Scale Package [LFCSP\_WD]  
3 mm x 3 mm Body, Very Very Thin, Dual Lead  
(CP-8-13)

Dimensions shown in millimeters

12-07-2010-A

## ORDERING GUIDE

| Model <sup>1</sup> | Temperature Range | Package Description               | Package Option | Branding |
|--------------------|-------------------|-----------------------------------|----------------|----------|
| ADL5541ACPZ-R7     | -40°C to +85°C    | 8-Lead LFCSP_WD, 7" Tape and Reel | CP-8-13        | Q13      |
| ADL5541-EVALZ      |                   | Evaluation Board                  |                |          |

<sup>1</sup> Z = RoHS Compliant Part.

## Данный компонент на территории Российской Федерации

### Вы можете приобрести в компании MosChip.

Для оперативного оформления запроса Вам необходимо перейти по данной ссылке:

<http://moschip.ru/get-element>

Вы можете разместить у нас заказ для любого Вашего проекта, будь то серийное производство или разработка единичного прибора.

В нашем ассортименте представлены ведущие мировые производители активных и пассивных электронных компонентов.

Нашей специализацией является поставка электронной компонентной базы двойного назначения, продукции таких производителей как XILINX, Intel (ex.ALTERA), Vicor, Microchip, Texas Instruments, Analog Devices, Mini-Circuits, Amphenol, Glenair.

Сотрудничество с глобальными дистрибьюторами электронных компонентов, предоставляет возможность заказывать и получать с международных складов практически любой перечень компонентов в оптимальные для Вас сроки.

На всех этапах разработки и производства наши партнеры могут получить квалифицированную поддержку опытных инженеров.

Система менеджмента качества компании отвечает требованиям в соответствии с ГОСТ Р ИСО 9001, ГОСТ РВ 0015-002 и ЭС РД 009

### Офис по работе с юридическими лицами:

105318, г.Москва, ул.Щербаковская д.3, офис 1107, 1118, ДЦ «Щербаковский»

Телефон: +7 495 668-12-70 (многоканальный)

Факс: +7 495 668-12-70 (доб.304)

E-mail: [info@moschip.ru](mailto:info@moschip.ru)

Skype отдела продаж:

moschip.ru

moschip.ru\_4

moschip.ru\_6

moschip.ru\_9