

DPDT Coaxial Switches DC to 6 GHz, DC to 20 GHz, DC to 26.5 GHz, DC to 40 GHz

Radiall's PLATINUM SERIES switches are optimised to perform at a high level over an extended life span. With outstanding RF performances, and a guaranteed Insertion Loss repeatability of 0.03 dB over a life span of 10 million switching cycles. PLATINUM SERIES switches are perfect for automated test and measurement equipment, as well as signal monitoring devices.

PART NUMBER SELECTION

NEW

R 593 . 7 3 1 4 . .

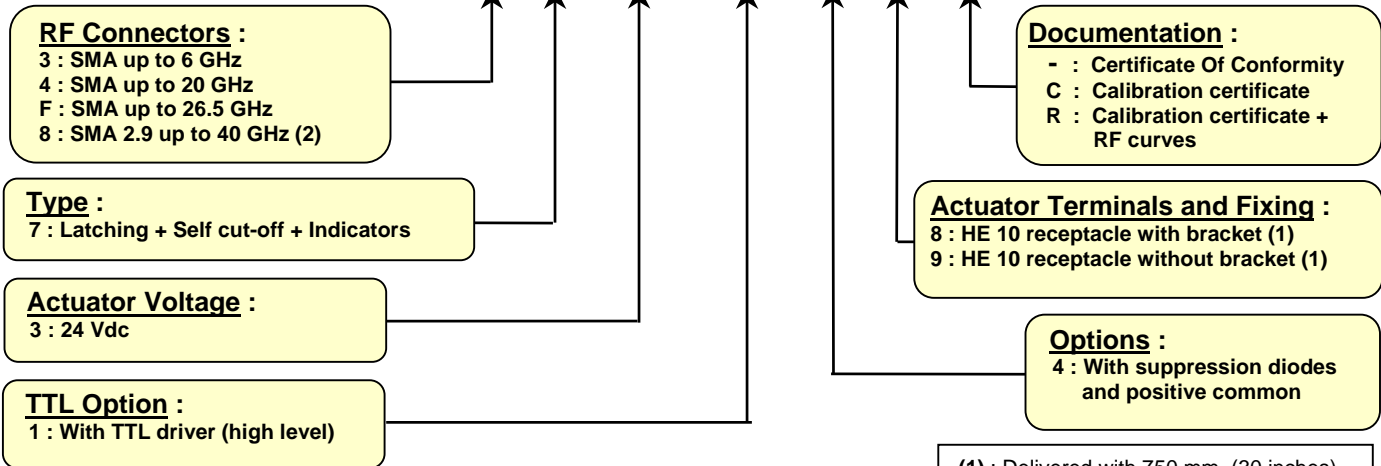

(1) : Delivered with 750 mm (30 inches) ribbon cable + HE10 connector

PICTURE



Note (2) : Connector SMA 2.9 is equivalent too "K connector®"
 ® - Registered trademark of Anritsu

In the continual goal to improve our products, we reserve the right to make any modification judged necessary

RF PERFORMANCES

| PART NUMBER | R59337314- | R59347314- | R593F7314- | R59387314- |
|----------------------------------|-------------------------------|--|--|---|
| Frequency Range GHz | DC to 6 | DC to 20 | DC to 26.5 | DC to 40 |
| Impedance Ohms | 50 | | | |
| Insertion Loss dB (Maximum) | 0.2 + 0.025 x frequency (GHz) | | | |
| Isolation dB (Minimum) | 100 | DC to 6 GHz : 100 6 to 12.4 GHz : 90 12.4 to 20 GHz : 80 | DC to 6 GHz : 100 6 to 12.4 GHz : 90 12.4 to 20 GHz : 80 20 to 26.5 GHz : 65 | DC to 6 GHz : 100 6 to 12.4 GHz : 90 12.4 to 20 GHz : 80 20 to 26.5 GHz : 65 26.5 to 40 GHz : 60 |
| V.S.W.R. (Maximum) | 1.20 | DC to 6 GHz : 1.20 6 to 12.4 GHz : 1.25 12.4 to 18 GHz : 1.40 18 to 20 GHz : 1.65 | DC to 6 GHz : 1.20 6 to 12.4 GHz : 1.25 12.4 to 18 GHz : 1.40 18 to 26.5 GHz : 1.65 | DC to 6 GHz : 1.20 6 to 12.4 GHz : 1.25 12.4 to 18 GHz : 1.40 18 to 26.5 GHz : 1.65 26.5 to 40 GHz : 1.70 |
| Repeatability (measured at 25°C) | 0.03 dB | | | 0.05 dB |

TYPICAL RF PERFORMANCES

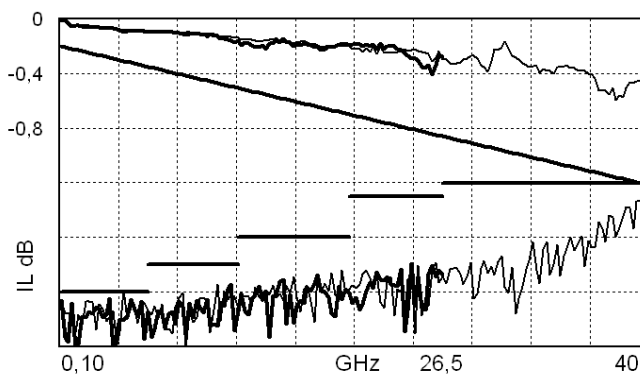

Insertion Loss and Isolation

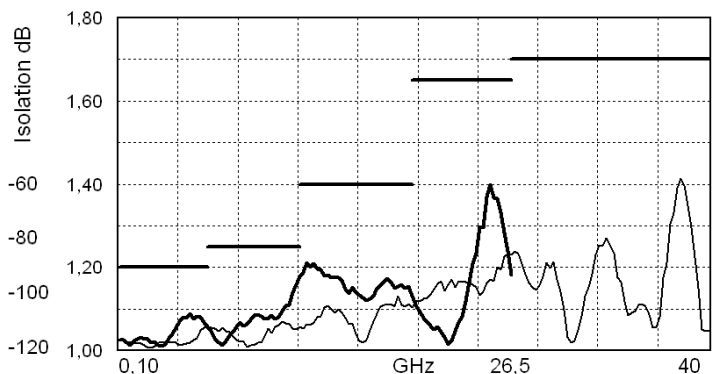

V.S.W.R.

: 26.5 GHz model with SMA /
 : 40 GHz

In the continual goal to improve our products, we reserve the right to make any modification judged necessary

ADDITIONAL SPECIFICATIONS

| | | | |
|---|------------|---|-------------------|
| Operating mode | | Latching | |
| Nominal operating voltage (across operating temperature) Vdc | | 24 (20 / 32) | |
| Coil resistance (+/-10%) | Ohms | 120 | |
| Nominal operating current at 23°C | | 200 | |
| Maximum stand-by current | | 50 | |
| Average power | | RF path Cold switching : see Power Rating Chart on page 6 Hot switching : 1 Watt CW | |
| TTL input | High Level | 3 to 7 V | 1.4 mA max at 7 V |
| | Low Level | 0 to 0.8 V | |
| Indicator specifications | | Maximum withstanding voltage : 60V Maximum current capacity : 150 mA Maximum « ON » resistance : 2.5 Ω Minimum « OFF » resistance : 100 MΩ | |
| Switching time (max) | | 15 | |
| Life (min) for | SMA | 10 million cycles | |
| | SMA 2.9 | 5 million cycles | |
| Connectors | | SMA – SMA 2.9 | |
| Actuator terminal | | HE10 ribbon receptacle | |
| Weight (max) | g | 110 | |

ENVIRONMENTAL SPECIFICATIONS

| | | |
|---|----|-----------------------------------|
| Operating temperature range | °C | -25 to +75 |
| Storage temperature range | °C | -55 to +85 |
| Temperature cycling (MIL-STD-202 , Method 107D , Cond.A) | °C | -55 to +85 (10 cycles) |
| Vibration (MIL STD 202 , Method 204D , Cond.D) | | 10-2000 Hz , 10g operating |
| Shock (MIL STD 202 , Method 213B , Cond.C) | | 50g / 6 ms , ½ sine operating |
| Moisture resistance (MIL STD 202 , Method 106E , Cond.E) | | 65°C, 95% RH, 10 days |
| Altitude storage (MIL STD 202 , Method 105C , Cond.B) | | 50,000 feet (15,240 meters) |
| RFI (MIL STD 1344 , Method 3008 or IEC 61726) | | 40dB at 20GHz |

In the continual goal to improve our products, we reserve the right to make any modification judged necessary

DRIVING THE SWITCH

There is two positions for a transfer switch. Each RF path can be closed by applying Ground or TTL "High" to the corresponding "drive" pin.

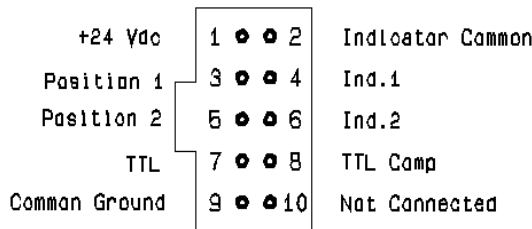

Switch connector

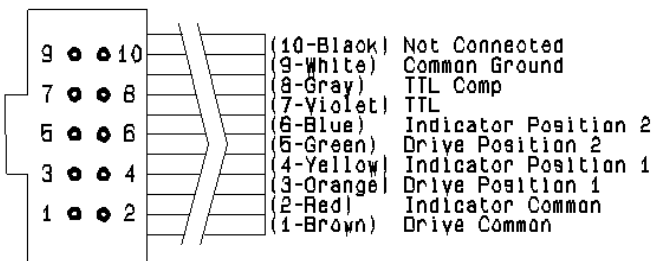

Mating cable connector

SCHEMATIC DIAGRAM

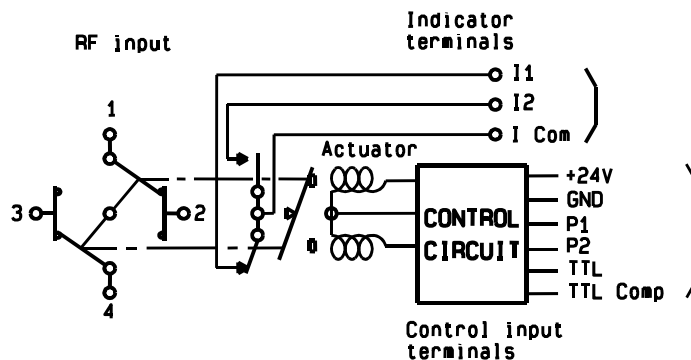

| | RF continuity | Indicator |
|------------|---------------|-----------|
| Position 1 | 1-2 / 3-4 | ICom - I1 |
| Position 2 | 1-3 / 2-4 | ICom - I2 |

Standard drive

- Connect pin 9 to ground (See note 1).
- Connect pin 1 to supply (+20 VDC to +32 VDC)
- Select (close) desired RF paths by applying Ground to the corresponding "drive" pin (Ex: apply Ground to pin 3 to close RF path 1-2 and 3-4).
- To select the second path, ensure that unwanted RF path "drive" pin are disconnected from Ground. Apply Ground to the "drive" pin which corresponds to the desired RF paths (Ex: apply Ground to pin 5 to close RF path 1-3 and 2-4).

TTL drive (Dual line)

- Connect pin 9 to ground.
- Connect pin 1 to supply (+20 VDC to +32 VDC)
- Select (close) desired RF path by applying TTL "High" to the corresponding "drive" pin (Ex: apply TTL "High" to pin 7 and TTL "Low" to pin 8 to close RF paths position 1).
- To select the second path, ensure that unwanted RF path "drive" pins are in TTL "Low" position. Apply TTL "High" to the "drive" pin which correspond to the desired RF path and TTL "low" to the undesired. (Ex: apply TTL "High" to pin 8 and TTL "Low" to pin 7 to close RF paths position 2).

TTL drive (Single line)

- Connect pin 9 to ground.
- Connect pin 1 to supply (+20 VDC to +32 VDC)
- Connect pin 8 to TTL "High".
- Select (close) position 1 by applying TTL "High" to pin 7 (Ex: apply TTL "High" to pin 7 to close RF paths 1-2 and 3-4).
- Select position 2 by applying TTL "Low" to pin 7 (Ex: apply TTL "Low" to pin 7 to close RF paths 1-3 and 2-4).

Note 1

Pin 9 does not need to be grounded for the switch to operate in standard drive. If pin 9 is not grounded, the position indicators will only function while the appropriate drive has applied. Therefore, if a pulse drive is used and continuous indicator operation is required, pin 9 must be grounded.

In the continual goal to improve our products, we reserve the right to make any modification judged necessary

ELECTRONIC POSITION INDICATORS

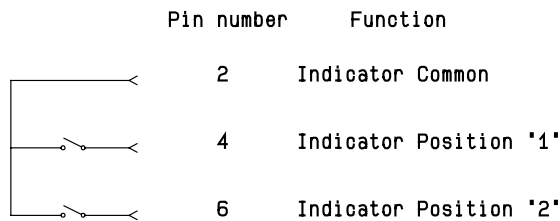

The electronic position indicators utilise photo-MOS transistors which are driven by the mechanical position of the RF paths moving elements. The circuitry consists of a common which can be connected to an output corresponding to selected RF path. The photo-MOS transistors are configured for AC and/or DC operation. The electronic position indicators require the supply (20 to 32 VDC) to be connected to pin 1 and ground connected to pin 9.

TYPICAL OUTLINE DRAWING

All dimensions are in millimetres/ inches.

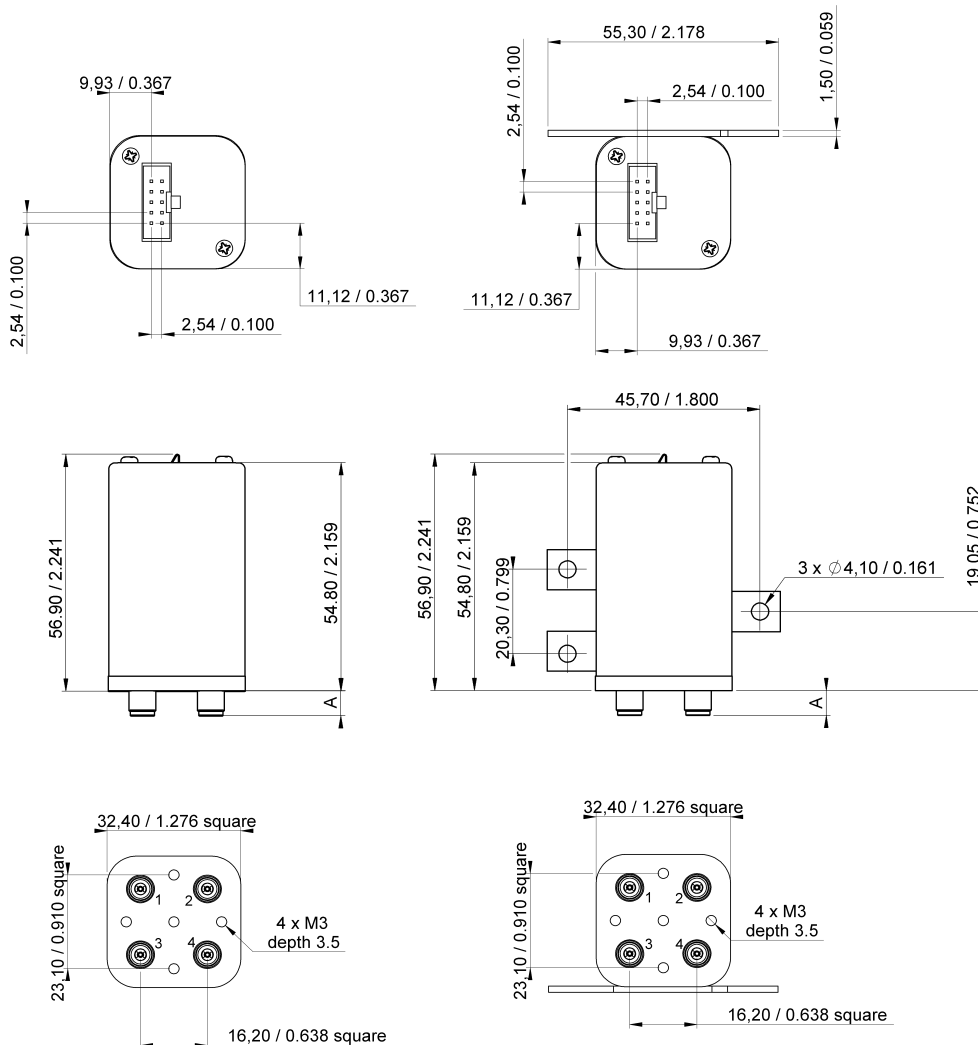

| Connectors | SMA | SMA 2.9 |
|------------|-----|---------|
| A max (mm) | 7.4 | 6.3 |

In the continual goal to improve our products, we reserve the right to make any modification judged necessary

POWER RATING CHART

This graph is based on the following conditions :

- Ambient temperature : + 25°C
- Sea level
- V.S.W.R. : 1 and cold switching



DERATING FACTOR VERSUS V.S.W.R.

The average power input must be reduced for load V.S.W.R. above 1.



In the continual goal to improve our products, we reserve the right to make any modification judged necessary

Данный компонент на территории Российской Федерации

Вы можете приобрести в компании MosChip.

Для оперативного оформления запроса Вам необходимо перейти по данной ссылке:

<http://moschip.ru/get-element>

Вы можете разместить у нас заказ для любого Вашего проекта, будь то серийное производство или разработка единичного прибора.

В нашем ассортименте представлены ведущие мировые производители активных и пассивных электронных компонентов.

Нашей специализацией является поставка электронной компонентной базы двойного назначения, продукции таких производителей как XILINX, Intel (ex.ALTERA), Vicor, Microchip, Texas Instruments, Analog Devices, Mini-Circuits, Amphenol, Glenair.

Сотрудничество с глобальными дистрибьюторами электронных компонентов, предоставляет возможность заказывать и получать с международных складов практически любой перечень компонентов в оптимальные для Вас сроки.

На всех этапах разработки и производства наши партнеры могут получить квалифицированную поддержку опытных инженеров.

Система менеджмента качества компании отвечает требованиям в соответствии с ГОСТ Р ИСО 9001, ГОСТ РВ 0015-002 и ЭС РД 009

Офис по работе с юридическими лицами:

105318, г.Москва, ул.Щербаковская д.3, офис 1107, 1118, ДЦ «Щербаковский»

Телефон: +7 495 668-12-70 (многоканальный)

Факс: +7 495 668-12-70 (доб.304)

E-mail: info@moschip.ru

Skype отдела продаж:

moschip.ru

moschip.ru_4

moschip.ru_6

moschip.ru_9