

60V N-CHANNEL ENHANCEMENT MODE MOSFET IN SOT89 PACKAGE

Product Summary

$V_{(BR)DSS}$	$R_{DS(on)}$ Max	I_D max $T_A = 25^\circ C$ (Note 5)
60V	120m Ω @ $V_{GS} = 10V$	3.6A
	180m Ω @ $V_{GS} = 4.5V$	2.9A

Features and Benefits

- Low On-Resistance
- Low Threshold
- Fast Switching Speed
- Low Gate Drive
- **Lead Free/RoHS Compliant (Note 1)**
- **"Green" Device (Note 2)**
- **Qualified to AEC-Q101 Standards for High Reliability**

Description and Applications

This MOSFET has been designed to minimize the on-state resistance ($R_{DS(on)}$) and yet maintain superior switching performance, making it ideal for high efficiency power management applications.

- DC-DC Converters
- Power Management functions
- Motor control
- Disconnect switches

Mechanical Data

- Case: SOT89
- Case Material: Molded Plastic, "Green" Molding Compound. UL Flammability Classification Rating 94V-0
- Moisture Sensitivity: Level 1 per J-STD-020
- Terminals: Matte Tin Finish
- Weight: 0.052 grams (approximate)

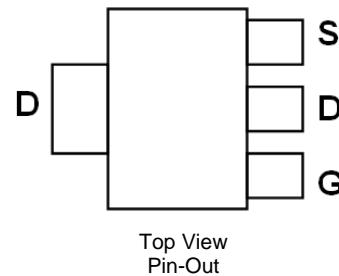
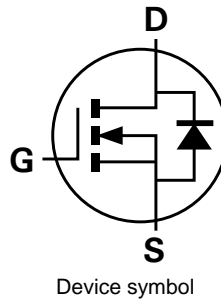
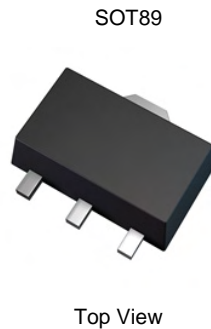

Ordering Information (Note 3)

Product	Marking	Reel size (inches)	Tape width (mm)	Quantity per reel
ZXMN6A11ZTA	11N6	7	12	1,000

- Notes:
1. No purposefully added lead.
 2. Diodes Inc's "Green" Policy can be found on our website at <http://www.diodes.com>
 3. For packaging details, go to our website at <http://www.diodes.com>

Marking Information

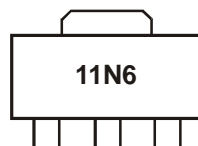

11N6 = Product type Marking Code

Maximum Ratings @T_A = 25°C unless otherwise specified

Characteristic		Symbol	Value	Unit
Drain-Source Voltage		V _{DS}	60	V
Gate-Source Voltage		V _{GSS}	±20	V
Continuous Drain Current	Steady State	@ V _{GS} = 10V ; T _A = 25°C (Note 5)	3.6	A
		@ V _{GS} = 10V ; T _A = 75°C (Note 5)	2.9	
		@ V _{GS} = 10V ; T _A = 25°C (Note 4)	2.7	
Pulsed Drain Current (Note 6)		I _{DM}	14.5	A
Continuous Source Current (Body Diode) (Note 5)		I _S	3.7	A
Pulsed Source Current (Body Diode) (Note 6)		I _{SM}	14.5	A

Thermal Characteristics @T_A = 25°C unless otherwise specified

Characteristic		Symbol	Value	Unit
Power Dissipation (Note 4)		P _D	1.5	W
Linear Derating Factor			12	mW/°C
Power Dissipation (Note 5)		P _D	2.6	W
Linear Derating Factor			21	mW/°C
Thermal Resistance, Junction to Ambient (Note 4)		R _{θJA}	83.3	°C/W
Thermal Resistance, Junction to Ambient (Note 5)		R _{θJA}	47.4	°C/W
Operating and Storage Temperature Range		T _J , T _{STG}	-55 to +150	°C

- Notes:
4. For a device surface mounted on 25mm x 25mm FR4 PCB with high coverage of single sided 1oz copper, in still air conditions.
 5. For a device surface mounted on FR4 PCB measured at t ≤ 10 sec.
 6. Repetitive rating - 25mm x 25mm FR4 PCB, D = 0.02, pulse width 300µs – pulse width limited by maximum junction temperature.

Thermal Characteristics

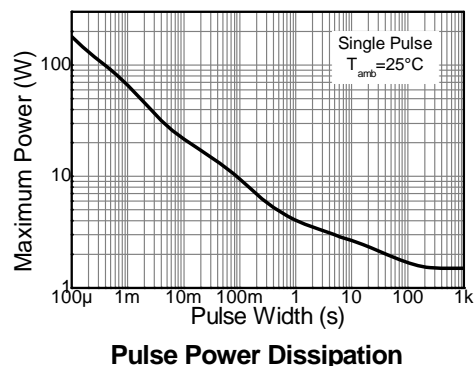
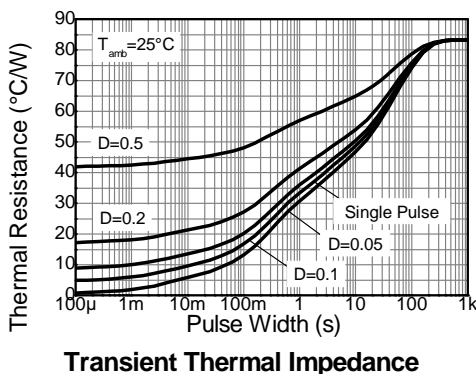
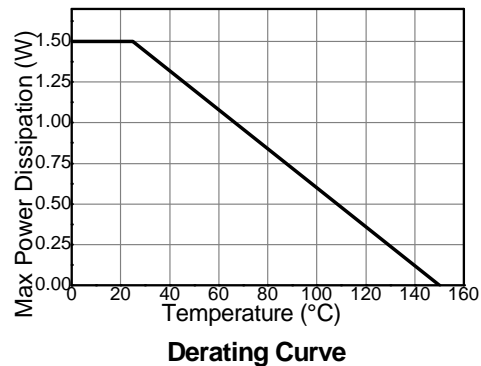
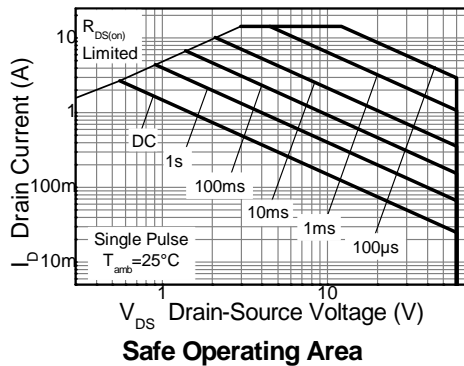

Electrical Characteristics @T_A = 25°C unless otherwise specified

Characteristic	Symbol	Min	Typ	Max	Unit	Test Condition
OFF CHARACTERISTICS						
Drain-Source Breakdown Voltage	BV _{DSS}	60	-	-	V	V _{GS} = 0V, I _D = 250μA
Zero Gate Voltage Drain Current T _J = 25°C	I _{DSS}	-	-	1.0	μA	V _{DS} = 60V, V _{GS} = 0V
Gate-Source Leakage	I _{GSS}	-	-	100	nA	V _{GS} = ±20V, V _{DS} = 0V
ON CHARACTERISTICS						
Gate Threshold Voltage	V _{GS(th)}	1	-	2.2	V	V _{DS} = V _{GS} , I _D = 250μA
Static Drain-Source On-Resistance (Note 7)	R _{DS(on)}	-	-	120	mΩ	V _{GS} = 10V, I _D = 2.5A
			-	180		V _{GS} = 4.5V, I _D = 2A
Forward Transconductance (Note 7 & 9)	g _{FS}	-	4.9	-	S	V _{DS} = 15V, I _D = 2.5A
Diodes Forward Voltage (Note 7)	V _{SD}	-	0.85	0.95	V	T _J = 25°C, I _S = 2.8A, V _{GS} = 10V
DYNAMIC CHARACTERISTICS						
Input Capacitance (Note 8 & 9)	C _{iss}	-	330	-	pF	V _{DS} = 40V, V _{GS} = 0V, f = 1.0MHz
Output Capacitance (Note 8 & 9)	C _{oss}	-	35.2	-	pF	
Reverse Transfer Capacitance (Note 8 & 9)	C _{rss}	-	17.1	-	pF	
Gate Charge (Note 8 & 9)	Q _g	-	3	-	nC	V _{GS} = 5V, V _{DS} = 15V, I _D = 2.5A
Total Gate Charge (Note 8 & 9)	Q _g	-	5.7	-	nC	V _{GS} = 10V, V _{DS} = 15V, I _D = 2.5A
Gate-Source Charge (Note 8 & 9)	Q _{gs}	-	1.25	-	nC	
Gate-Drain Charge (Note 8 & 9)	Q _{gd}	-	0.86	-	nC	
Reverse Recovery Time (Note 9)	t _{rr}		21.5		ns	T _J = 25°C, I _S = 2.5A,
Reverse Recovery Charge (Note 9)	Q _{rr}		20.5		nC	di/dt = 100A/μs
Turn-On Delay Time (Note 8 & 9)	t _{D(on)}	-	1.95	-	ns	V _{GS} = 10V, V _{DD} = 30V, R _G = 6Ω, I _D = 2.5A
Turn-On Rise Time (Note 8 & 9)	t _r	-	3.5	-	ns	
Turn-Off Delay Time (Note 8 & 9)	t _{D(off)}	-	8.2	-	ns	
Turn-Off Fall Time (Note 8 & 9)	t _f	-	4.6	-	ns	

- Notes:
7. Measured under pulsed conditions. Pulse width ≤ 300μs; duty cycle ≤ 2%.
 8. Switching characteristics are independent of operating junction temperature.
 9. For design aid only, not subject to production testing.

Typical Characteristics

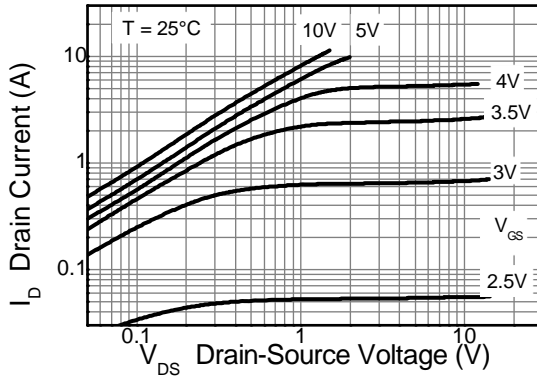

Output Characteristics

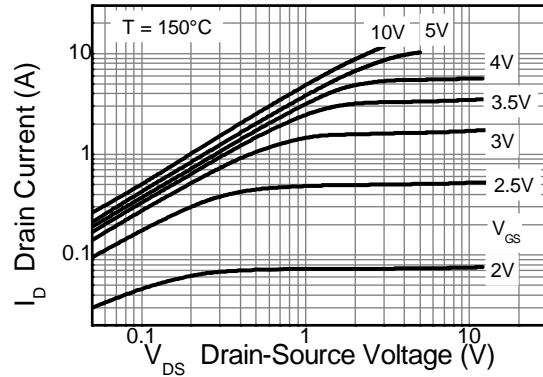

Output Characteristics

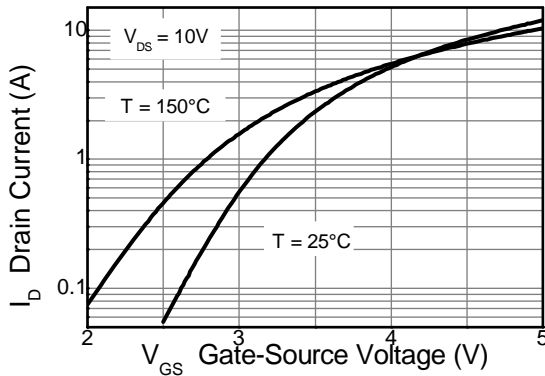

Typical Transfer Characteristics

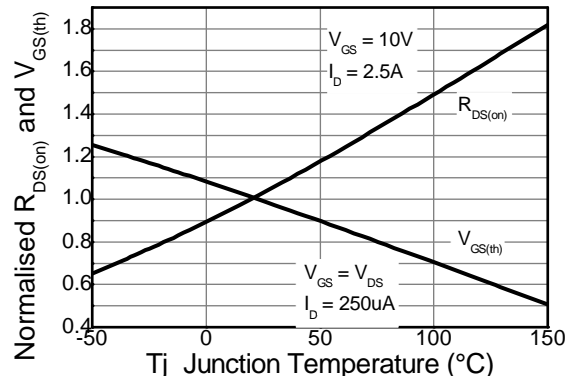

Normalised Curves v Temperature

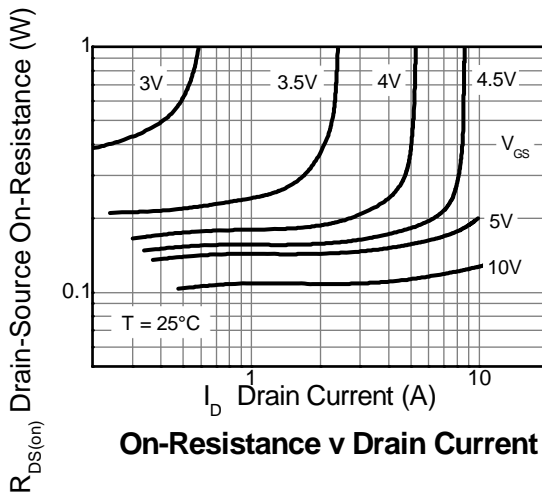

On-Resistance v Drain Current

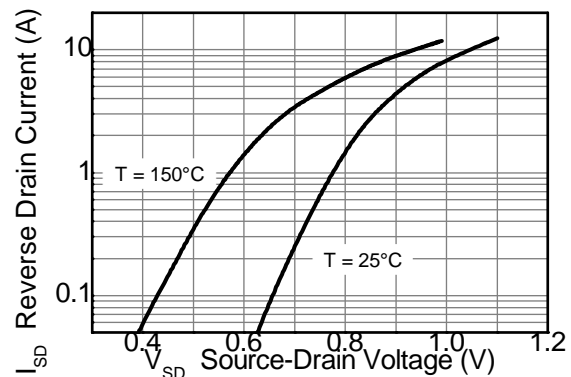

Source-Drain Diode Forward Voltage

Typical Characteristics - Continued

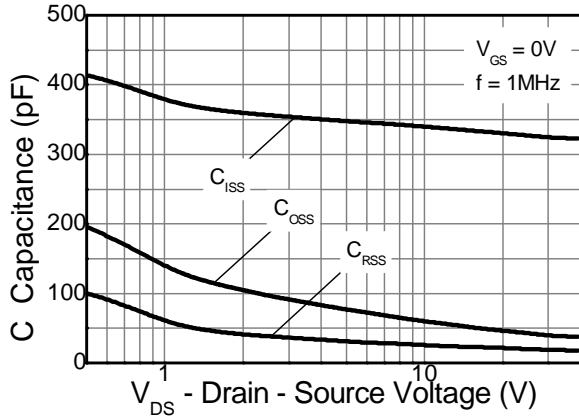

Capacitance v Drain-Source Voltage

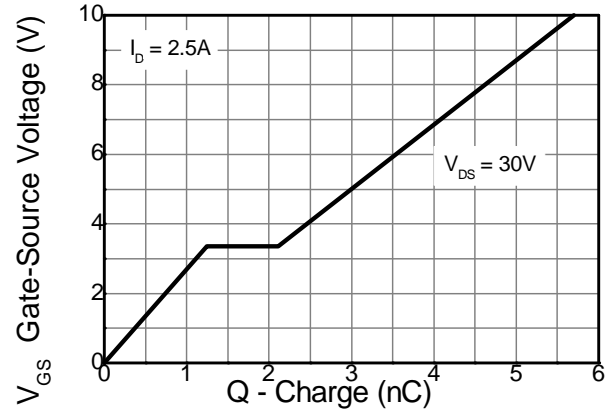

Gate-Source Voltage v Gate Charge

Test Circuits

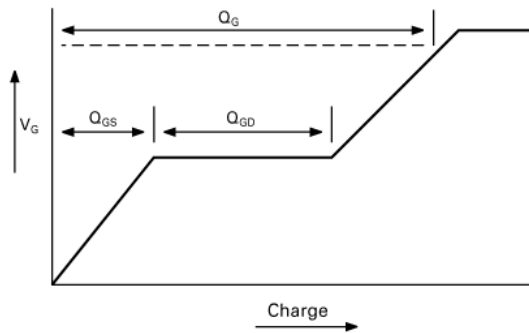

Basic gate charge waveform

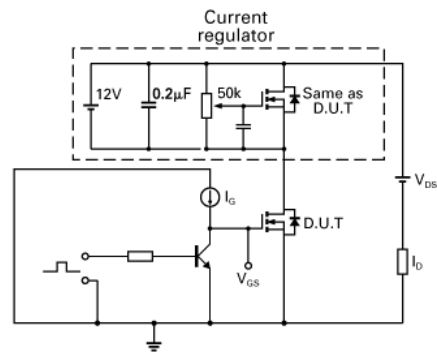

Gate charge test circuit

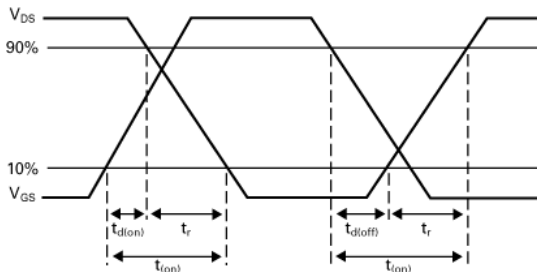

Switching time waveforms

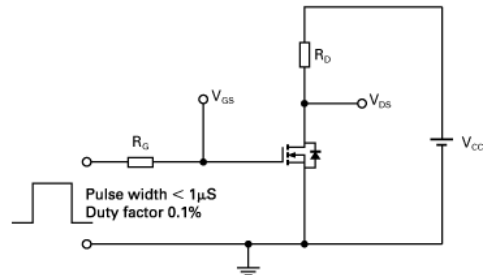

Switching time test circuit

Package Outline Dimensions

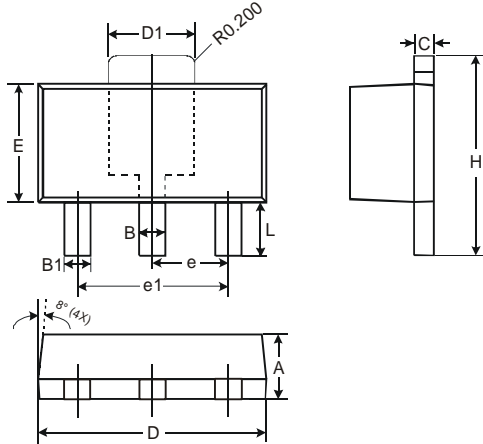

SOT89		
Dim	Min	Max
A	1.40	1.60
B	0.44	0.62
B1	0.35	0.54
C	0.35	0.43
D	4.40	4.60
D1	1.52	1.83
E	2.29	2.60
e	1.50 Typ	
e1	3.00 Typ	
H	3.94	4.25
L	0.89	1.20
All Dimensions in mm		

Suggested Pad Layout

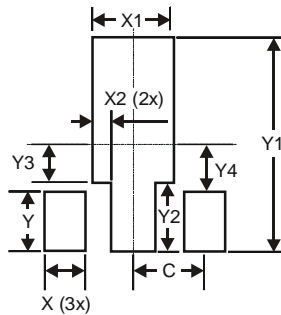

Dimensions	Value (in mm)
X	0.900
X1	1.733
X2	0.416
Y	1.300
Y1	4.600
Y2	1.475
Y3	0.950
Y4	1.125
C	1.500

IMPORTANT NOTICE

DIODES INCORPORATED MAKES NO WARRANTY OF ANY KIND, EXPRESS OR IMPLIED, WITH REGARDS TO THIS DOCUMENT, INCLUDING, BUT NOT LIMITED TO, THE IMPLIED WARRANTIES OF MERCHANTABILITY AND FITNESS FOR A PARTICULAR PURPOSE (AND THEIR EQUIVALENTS UNDER THE LAWS OF ANY JURISDICTION).

Diodes Incorporated and its subsidiaries reserve the right to make modifications, enhancements, improvements, corrections or other changes without further notice to this document and any product described herein. Diodes Incorporated does not assume any liability arising out of the application or use of this document or any product described herein; neither does Diodes Incorporated convey any license under its patent or trademark rights, nor the rights of others. Any Customer or user of this document or products described herein in such applications shall assume all risks of such use and will agree to hold Diodes Incorporated and all the companies whose products are represented on Diodes Incorporated website, harmless against all damages.

Diodes Incorporated does not warrant or accept any liability whatsoever in respect of any products purchased through unauthorized sales channel. Should Customers purchase or use Diodes Incorporated products for any unintended or unauthorized application, Customers shall indemnify and hold Diodes Incorporated and its representatives harmless against all claims, damages, expenses, and attorney fees arising out of, directly or indirectly, any claim of personal injury or death associated with such unintended or unauthorized application.

Products described herein may be covered by one or more United States, international or foreign patents pending. Product names and markings noted herein may also be covered by one or more United States, international or foreign trademarks.

LIFE SUPPORT

Diodes Incorporated products are specifically not authorized for use as critical components in life support devices or systems without the express written approval of the Chief Executive Officer of Diodes Incorporated. As used herein:

A. Life support devices or systems are devices or systems which:

1. are intended to implant into the body, or
2. support or sustain life and whose failure to perform when properly used in accordance with instructions for use provided in the labeling can be reasonably expected to result in significant injury to the user.

B. A critical component is any component in a life support device or system whose failure to perform can be reasonably expected to cause the failure of the life support device or to affect its safety or effectiveness.

Customers represent that they have all necessary expertise in the safety and regulatory ramifications of their life support devices or systems, and acknowledge and agree that they are solely responsible for all legal, regulatory and safety-related requirements concerning their products and any use of Diodes Incorporated products in such safety-critical, life support devices or systems, notwithstanding any devices- or systems-related information or support that may be provided by Diodes Incorporated. Further, Customers must fully indemnify Diodes Incorporated and its representatives against any damages arising out of the use of Diodes Incorporated products in such safety-critical, life support devices or systems.

Copyright © 2011, Diodes Incorporated

www.diodes.com

Данный компонент на территории Российской Федерации

Вы можете приобрести в компании MosChip.

Для оперативного оформления запроса Вам необходимо перейти по данной ссылке:

<http://moschip.ru/get-element>

Вы можете разместить у нас заказ для любого Вашего проекта, будь то серийное производство или разработка единичного прибора.

В нашем ассортименте представлены ведущие мировые производители активных и пассивных электронных компонентов.

Нашей специализацией является поставка электронной компонентной базы двойного назначения, продукции таких производителей как XILINX, Intel (ex.ALTERA), Vicor, Microchip, Texas Instruments, Analog Devices, Mini-Circuits, Amphenol, Glenair.

Сотрудничество с глобальными дистрибьюторами электронных компонентов, предоставляет возможность заказывать и получать с международных складов практически любой перечень компонентов в оптимальные для Вас сроки.

На всех этапах разработки и производства наши партнеры могут получить квалифицированную поддержку опытных инженеров.

Система менеджмента качества компании отвечает требованиям в соответствии с ГОСТ Р ИСО 9001, ГОСТ РВ 0015-002 и ЭС РД 009

Офис по работе с юридическими лицами:

105318, г.Москва, ул.Щербаковская д.3, офис 1107, 1118, ДЦ «Щербаковский»

Телефон: +7 495 668-12-70 (многоканальный)

Факс: +7 495 668-12-70 (доб.304)

E-mail: info@moschip.ru

Skype отдела продаж:

moschip.ru

moschip.ru_4

moschip.ru_6

moschip.ru_9