

Standard SMD LED PLCC-2

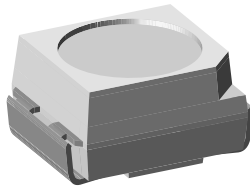

94 8553

DESCRIPTION

This device has been designed for applications requiring narrow brightness and color selection.

The package of this device is the PLCC-2.

It consists of a lead frame which is embedded in a white thermoplast. The reflector inside this package is filled up with clear epoxy.

PRODUCT GROUP AND PACKAGE DATA

- Product group: LED
- Package: SMD PLCC-2
- Product series: standard
- Angle of half intensity: $\pm 60^\circ$

FEATURES

- SMD LED with exceptional brightness
- Luminous intensity categorized
- Compatible with automatic placement equipment
- EIA and ICE standard package
- Compatible with IR reflow, vapor phase and wave solder processes according to CECC 00802 and J-STD-020C
- Available in 8 mm tape
- Low profile package
- Non-diffused lens: excellent for coupling to light pipes and backlighting
- Low power consumption
- Component in accordance to RoHS 2002/95/EC and WEEE 2002/96/EC
- Luminous intensity ratio in one packaging unit $I_{Vmax}/I_{Vmin} \leq 1.6$
- Lead (Pb)-free device
- Preconditioning: acc. to JEDEC level 2a
- ESD-withstand voltage: up to 2 kV according to JESD22-A114-B



APPLICATIONS

- Automotive: backlighting in dashboards and switches
- Telecommunication: indicator and backlighting in telephone and fax
- Indicator and backlight for audio and video equipment
- Indicator and backlight in office equipment
- Flat backlight for LCDs, switches and symbols
- General use

PARTS TABLE

PART	COLOR, LUMINOUS INTENSITY	TECHNOLOGY
VLMD3100-GS08	Red, $I_V > 11.2$ mcd	GaAlAs on GaAs
VLMD3100-GS18	Red, $I_V > 11.2$ mcd	GaAlAs on GaAs
VLMD3101-GS08	Red, $I_V = (18 \text{ to } 45)$ mcd	GaAlAs on GaAs
VLMD3101-GS18	Red, $I_V = (18 \text{ to } 45)$ mcd	GaAlAs on GaAs
VLMD3105-GS08	Red, $I_V = (11.2 \text{ to } 28)$ mcd	GaAlAs on GaAs
VLMD3105-GS18	Red, $I_V = (11.2 \text{ to } 28)$ mcd	GaAlAs on GaAs
VLMD31L2N1-GS08	Red, $I_V = (14 \text{ to } 35.5)$ mcd	GaAlAs on GaAs
VLMD31L2N1-GS18	Red, $I_V = (14 \text{ to } 35.5)$ mcd	GaAlAs on GaAs
VLMD31L2P1-GS08	Red, $I_V = (14 \text{ to } 56)$ mcd	GaAlAs on GaAs
VLMD31L2P1-GS18	Red, $I_V = (14 \text{ to } 56)$ mcd	GaAlAs on GaAs
VLMD31M2P1-GS08	Red, $I_V = (22.4 \text{ to } 56)$ mcd	GaAlAs on GaAs
VLMD31M2P1-GS18	Red, $I_V = (22.4 \text{ to } 56)$ mcd	GaAlAs on GaAs

ABSOLUTE MAXIMUM RATINGS ¹⁾ VLMD31..				
PARAMETER	TEST CONDITION	SYMBOL	VALUE	UNIT
Reverse voltage ²⁾		V_R	6	V
DC Forward current	$T_{amb} \leq 60\text{ }^\circ\text{C}$	I_F	30	mA
Surge forward current	$t_p \leq 10\text{ }\mu\text{s}$	I_{FSM}	0.5	A
Power dissipation		P_V	100	mW
Junction temperature		T_j	100	$^\circ\text{C}$
Operating temperature range		T_{amb}	- 40 to + 100	$^\circ\text{C}$
Storage temperature range		T_{stg}	- 40 to + 100	$^\circ\text{C}$
Soldering temperature	$t \leq 5\text{ s}$	T_{sd}	260	$^\circ\text{C}$
Thermal resistance junction/ambient	mounted on PC board (pad size > 16 mm ²)	R_{thJA}	400	K/W

Note:

¹⁾ $T_{amb} = 25\text{ }^\circ\text{C}$, unless otherwise specified

²⁾ Driving LED in reverse direction is suitable for short term application

OPTICAL AND ELECTRICAL CHARACTERISTICS ¹⁾ VLMD31.., RED							
PARAMETER	TEST CONDITION	PART	SYMBOL	MIN.	TYP.	MAX.	UNIT
Luminous intensity ²⁾	$I_F = 10\text{ mA}$	VLMD3100	I_V	11.2			mcd
		VLMD3101	I_V	18		45	mcd
		VLMD3105	I_V	11.2		28	mcd
		VLMD31L2N1	I_V	14		35.5	mcd
		VLMD31L2P1	I_V	14		56	mcd
		VLMD31M2P1	I_V	22.4		56	mcd
Dominant wavelength	$I_F = 10\text{ mA}$		λ_d		648		nm
Peak wavelength	$I_F = 10\text{ mA}$		λ_p		650		nm
Angle of half intensity	$I_F = 10\text{ mA}$		φ		± 60		deg
Forward voltage	$I_F = 20\text{ mA}$		V_F		1.8	2.2	V
Reverse voltage	$I_R = 10\text{ }\mu\text{A}$		V_R	6			V
Junction capacitance	$V_R = 0, f = 1\text{ MHz}$		C_j		7		pF
Temperature coefficient of V_F	$I_F = 20\text{ mA}$		TC_{V_F}		- 1.8		mV/K
Temperature coefficient of λ_d	$I_F = 10\text{ mA}$		TC_{λ_d}		0.05		nm/K

Note:

¹⁾ $T_{amb} = 25\text{ }^\circ\text{C}$, unless otherwise specified

²⁾ In one packing unit $I_{Vmax}/I_{Vmin} \leq 1.6$

LUMINOUS INTENSITY CLASSIFICATION				
GROUP	LIGHT INTENSITY (mcd)			
	STANDARD	OPTIONAL	MIN.	MAX.
J	1	4.5	5.6	
	2	5.6	7.1	
K	1	7.1	9	
	2	9	11.2	
L	1	11.2	14	
	2	14	18	
M	1	18	22.4	
	2	22.4	28	
N	1	28	35.5	
	2	35.5	45	
P	1	45	56	

Note:

Luminous intensity is tested at a current pulse duration of 25 ms and an accuracy of $\pm 11\%$.

The above Type Numbers represent the order groups which include only a few brightness groups. Only one group will be shipped on each reel (there will be no mixing of two groups on each reel). In order to ensure availability, single brightness groups will not be orderable.

In a similar manner for colors where wavelength groups are measured and binned, single wavelength groups will be shipped on any one reel.

In order to ensure availability, single wavelength groups will not be orderable.

CROSSING TABLE	
VISHAY	OSRAM
VLMD31L2N1	LHT674-L2N1
VLMD31L2P1	LHT674-L2P1
VLMD31M2P1	LHT674-M2P1

TYPICAL CHARACTERISTICS

$T_{amb} = 25\text{ }^{\circ}\text{C}$, unless otherwise specified

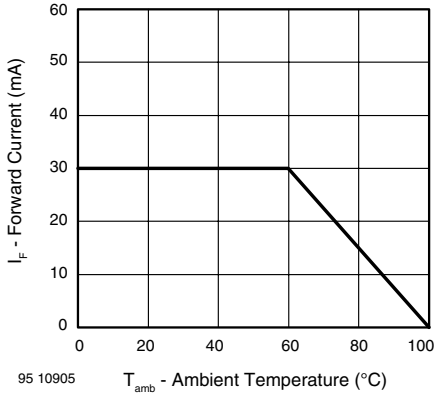

Figure 1. Max. Permissible Forward Current vs. Ambient Temperature

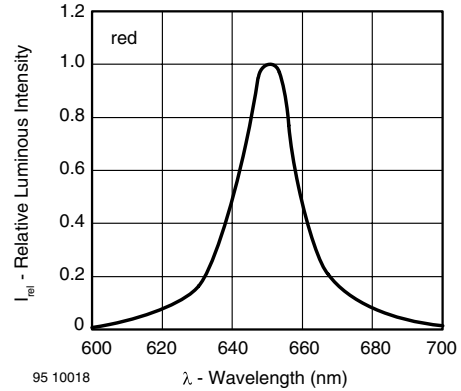

Figure 4. Relative Luminous Intensity vs. Wavelength

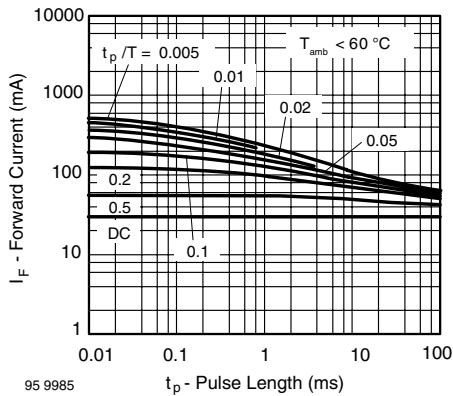

Figure 2. Permissible Pulse Forward Current vs. Pulse Length

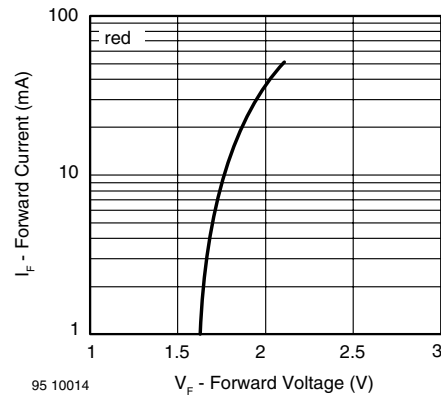

Figure 5. Forward Current vs. Forward Voltage

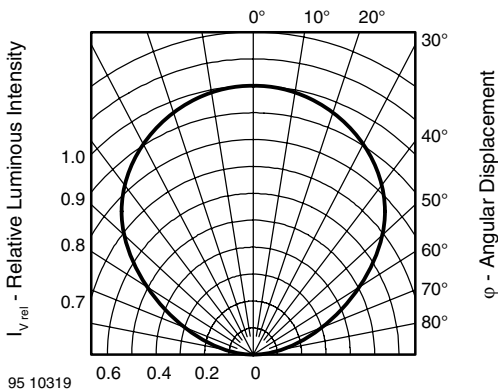

Figure 3. Rel. Luminous Intensity vs. Angular Displacement

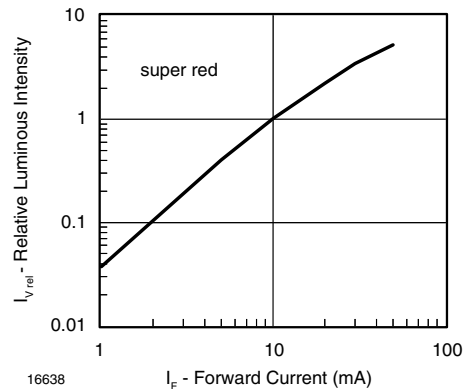

Figure 6. Relative Luminous Intensity vs. Forward Current

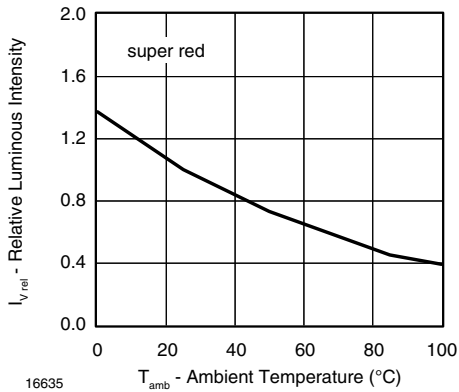

Figure 7. Rel. Luminous Intensity vs. Ambient Temperature

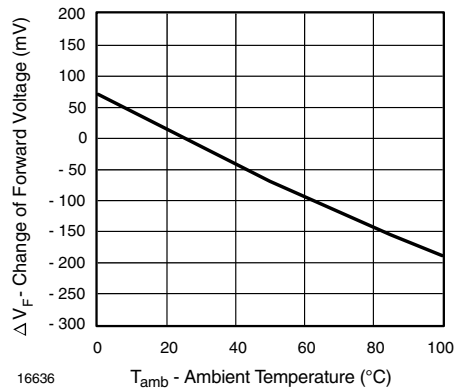

Figure 9. Change of Forward Voltage vs. Ambient Temperature

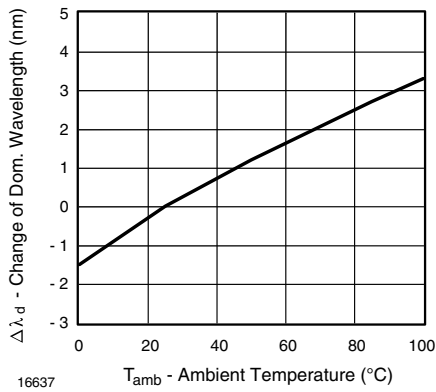
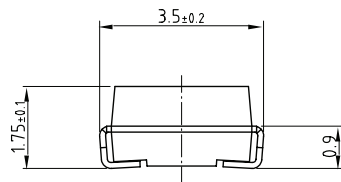
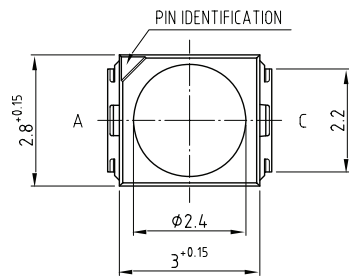

Figure 8. Change of Dominant Wavelength vs. Ambient Temperature

PACKAGE DIMENSIONS in millimeters



Technical drawings according to DIN specifications



Mounting Pad Layout

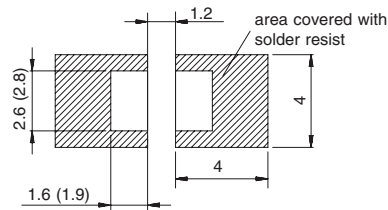

Drawing-No.: 6.541-5025.02-4
 Issue: 4; 21.11.05
 20415

METHOD OF TAPING/POLARITY AND TAPE AND REEL
SMD LED (VLM.3-SERIES)

Vishay's LEDs in SMD packages are available in an antistatic 8 mm blister tape (in accordance with DIN IEC 40 (CO) 564) for automatic component insertion. The blister tape is a plastic strip with impressed component cavities, covered by a top tape.

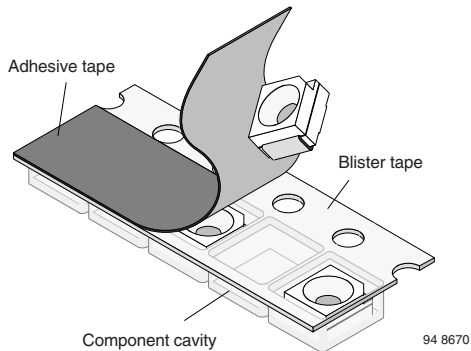

TAPING OF VLMD31..

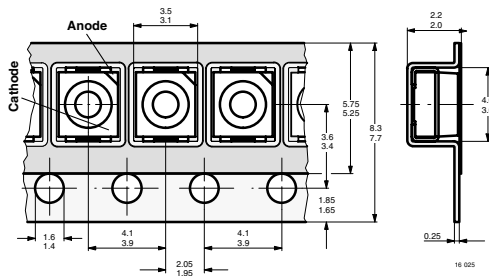

Figure 10. Tape Dimensions in mm for PLCC-2

REEL PACKAGE DIMENSION IN MM FOR SMD LED, TAPE OPTION GS08 (= 1500 PCS.)

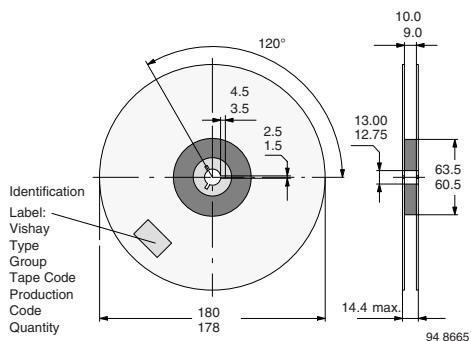

Figure 11. Reel Dimensions - GS08

REEL PACKAGE DIMENSION IN MM FOR SMD LED, TAPE OPTION GS18 (= 8000 PCS.) PREFERRED

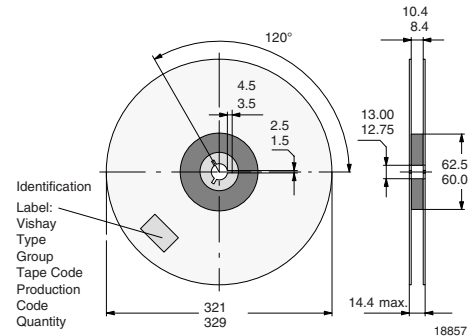

Figure 12. Reel Dimensions - GS18

SOLDERING PROFILE

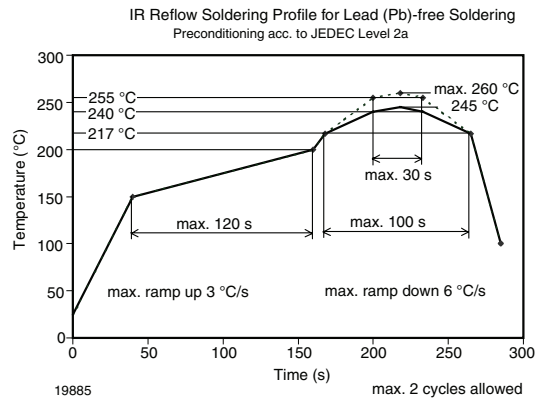

Figure 13. Vishay Lead (Pb)-free Reflow Soldering Profile (acc. to J-STD-020C)

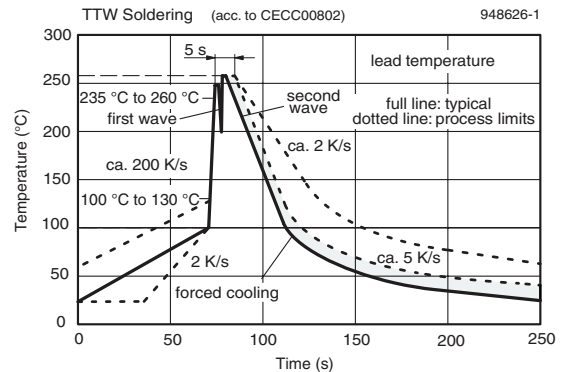
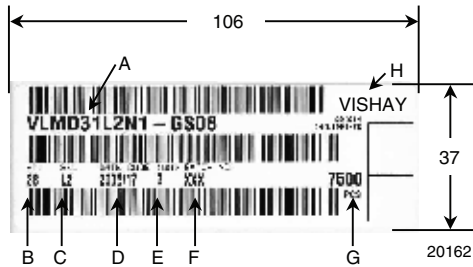

Figure 14. Double Wave Soldering of Opto Devices (all Packages)

BAR CODE PRODUCT LABEL



- A) Type of component
- B) Manufacturing plant
- C) SEL - selection code (bin):
e.g.: L2 = code for luminous intensity group
- D) Date code year/week
- E) Day code (e.g. 3: Wednesday)
- F) Batch no.
- G) Total quantity
- H) Company code

DRY PACKING

The reel is packed in an anti-humidity bag to protect the devices from absorbing moisture during transportation and storage.

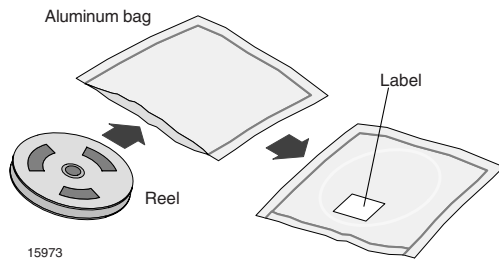

FINAL PACKING

The sealed reel is packed into a cardboard box. A secondary cardboard box is used for shipping purposes.

RECOMMENDED METHOD OF STORAGE

Dry box storage is recommended as soon as the aluminum bag has been opened to prevent moisture absorption. The following conditions should be observed, if dry boxes are not available:

- Storage temperature 10 °C to 30 °C
- Storage humidity ≤ 60 % RH max.

After more than 672 h under these conditions moisture content will be too high for reflow soldering.

In case of moisture absorption, the devices will recover to the former condition by drying under the following condition:

- 192 h at 40 °C + 5 °C/- 0 °C and < 5 % RH (dry air/nitrogen) or
- 96 h at 60 °C + 5 °C and < 5 % RH for all device containers or
- 24 h at 100 °C + 5 °C not suitable for reel or tubes.

An EIA JEDEC standard JESD22-A112 level 2a label is included on all dry bags.

CAUTION
This bag contains
MOISTURE-SENSITIVE DEVICES

LEVEL
2a

1. Shelf life in sealed bag 12 months at <40°C and < 90% relative humidity (RH)
2. After this bag is opened devices that will be subjected to infrared reflow, vapor-phase reflow, or equivalent processing (peak package body temp. 260°C) must be:
 - a) Mounted within **672 hours** at factory condition of ≤30°C/60%RH or
 - b) Stored at ≤10% RH.
3. Devices require baking before mounting if:
 - a) Humidity Indicator Card is >10% when read at 23°C ± 5°C or
 - b) 2a or 2b is not met.
4. If baking is required, devices may be baked for:

192 hours at 40°C + 5°C/-0°C and <5%RH (dry air/nitrogen)	or
96 hours at 60±5°C and <5%RH	For all device containers
24 hours at 100±5°C	Not suitable for reels or tubes

Bag Seal Date: _____
(If blank, see bar code label)

Note: LEVEL defined by EIA JEDEC Standard JESD22-A113

Example of JESD22-A112 level 2a label

ESD PRECAUTION

Proper storage and handling procedures should be followed to prevent ESD damage to the devices especially when they are removed from the antistatic shielding bag. Electro-static sensitive devices warning labels are on the packaging.

VISHAY SEMICONDUCTORS STANDARD BAR CODE LABELS

The Vishay Semiconductors standard bar code labels are printed at final packing areas. The labels are on each packing unit and contain Vishay Semiconductors specific data.



Ozone Depleting Substances Policy Statement

It is the policy of Vishay Semiconductor GmbH to

1. Meet all present and future national and international statutory requirements.
2. Regularly and continuously improve the performance of our products, processes, distribution and operating systems with respect to their impact on the health and safety of our employees and the public, as well as their impact on the environment.

It is particular concern to control or eliminate releases of those substances into the atmosphere which are known as ozone depleting substances (ODSs).

The Montreal Protocol (1987) and its London Amendments (1990) intend to severely restrict the use of ODSs and forbid their use within the next ten years. Various national and international initiatives are pressing for an earlier ban on these substances.

Vishay Semiconductor GmbH has been able to use its policy of continuous improvements to eliminate the use of ODSs listed in the following documents.

1. Annex A, B and list of transitional substances of the Montreal Protocol and the London Amendments respectively.
2. Class I and II ozone depleting substances in the Clean Air Act Amendments of 1990 by the Environmental Protection Agency (EPA) in the USA.
3. Council Decision 88/540/EEC and 91/690/EEC Annex A, B and C (transitional substances) respectively.

Vishay Semiconductor GmbH can certify that our semiconductors are not manufactured with ozone depleting substances and do not contain such substances.

We reserve the right to make changes to improve technical design
and may do so without further notice.

Parameters can vary in different applications. All operating parameters must be validated for each customer application by the customer. Should the buyer use Vishay Semiconductors products for any unintended or unauthorized application, the buyer shall indemnify Vishay Semiconductors against all claims, costs, damages, and expenses, arising out of, directly or indirectly, any claim of personal damage, injury or death associated with such unintended or unauthorized use.

Vishay Semiconductor GmbH, P.O.B. 3535, D-74025 Heilbronn, Germany



Disclaimer

All product specifications and data are subject to change without notice.

Vishay Intertechnology, Inc., its affiliates, agents, and employees, and all persons acting on its or their behalf (collectively, "Vishay"), disclaim any and all liability for any errors, inaccuracies or incompleteness contained herein or in any other disclosure relating to any product.

Vishay disclaims any and all liability arising out of the use or application of any product described herein or of any information provided herein to the maximum extent permitted by law. The product specifications do not expand or otherwise modify Vishay's terms and conditions of purchase, including but not limited to the warranty expressed therein, which apply to these products.

No license, express or implied, by estoppel or otherwise, to any intellectual property rights is granted by this document or by any conduct of Vishay.

The products shown herein are not designed for use in medical, life-saving, or life-sustaining applications unless otherwise expressly indicated. Customers using or selling Vishay products not expressly indicated for use in such applications do so entirely at their own risk and agree to fully indemnify Vishay for any damages arising or resulting from such use or sale. Please contact authorized Vishay personnel to obtain written terms and conditions regarding products designed for such applications.

Product names and markings noted herein may be trademarks of their respective owners.

Данный компонент на территории Российской Федерации

Вы можете приобрести в компании MosChip.

Для оперативного оформления запроса Вам необходимо перейти по данной ссылке:

<http://moschip.ru/get-element>

Вы можете разместить у нас заказ для любого Вашего проекта, будь то серийное производство или разработка единичного прибора.

В нашем ассортименте представлены ведущие мировые производители активных и пассивных электронных компонентов.

Нашей специализацией является поставка электронной компонентной базы двойного назначения, продукции таких производителей как XILINX, Intel (ex.ALTERA), Vicor, Microchip, Texas Instruments, Analog Devices, Mini-Circuits, Amphenol, Glenair.

Сотрудничество с глобальными дистрибьюторами электронных компонентов, предоставляет возможность заказывать и получать с международных складов практически любой перечень компонентов в оптимальные для Вас сроки.

На всех этапах разработки и производства наши партнеры могут получить квалифицированную поддержку опытных инженеров.

Система менеджмента качества компании отвечает требованиям в соответствии с ГОСТ Р ИСО 9001, ГОСТ РВ 0015-002 и ЭС РД 009

Офис по работе с юридическими лицами:

105318, г.Москва, ул.Щербаковская д.3, офис 1107, 1118, ДЦ «Щербаковский»

Телефон: +7 495 668-12-70 (многоканальный)

Факс: +7 495 668-12-70 (доб.304)

E-mail: info@moschip.ru

Skype отдела продаж:

moschip.ru

moschip.ru_4

moschip.ru_6

moschip.ru_9