



# Low-Power, High-Speed, Single-Supply Op Amp + Comparator + Reference ICs

MAX9000-MAX9005

## General Description

The MAX9000 family features the combination of a high-speed operational amplifier, a 185ns comparator, and a precision 1.230V reference. These devices operate from a single +2.5V to +5.5V supply and draw less than 500 $\mu$ A of quiescent current. The MAX9001/MAX9004 feature a shut-down mode that reduces supply current to 2 $\mu$ A and puts the outputs into a high-impedance state, making them ideal for portable and battery-powered applications.

The amplifiers in the MAX9000/MAX9001/MAX9002 are unity-gain stable with a 1.25MHz gain-bandwidth product, while the amplifiers in the MAX9003/MAX9004/MAX9005 are stable for closed-loop gains of +10V/V or greater with an 8MHz gain-bandwidth product. The input common-mode voltage extends from 150mV below the negative supply to within 1.2V of the positive supply for the amplifier, and to within 1.1V for the comparator. The amplifier and comparator outputs can swing Rail-to-Rail<sup>®</sup> and deliver up to  $\pm$ 2.5mA and  $\pm$ 4.0mA, respectively, to an external load while maintaining excellent DC accuracy. The unique design of the comparator output stage substantially reduces switching current during output transitions, virtually eliminating power-supply glitches.

The comparator's  $\pm$ 2mV of built-in hysteresis provides noise immunity and prevents oscillations even with a slow-moving input signal. The MAX9000/MAX9001/MAX9003/MAX9004 have an internal 1.230V  $\pm$ 1% precision reference with a low 8ppm/ $^{\circ}$ C temperature coefficient that can sink or source up to 1mA. The amplifier and reference are stable with capacitive loads up to 250pF and 100nF, respectively. The comparator's inverting input is internally connected to the reference output in the MAX9000/MAX9003.

## Applications

Single-Supply Zero-Crossing Detector	Photodiode Preamps
Instruments, Terminals, and Bar-Code Readers	Smart Card Readers
Keyless Entry	Infrared Receivers for Remote Controls
	Sensor Signal Detection

## Features

- ◆ Op Amp + Comparator + Reference in Space-Saving  $\mu$ MAX Package
- ◆ +2.5V to +5.5V Single-Supply Voltage Range
- ◆ 340 $\mu$ A Supply Current (MAX9002/MAX9005)
- ◆ Unity-Gain Stable (GBW = 1.25MHz) and Decompensated ( $A_V \geq 10V/V$ , GBW = 8MHz) Options
- ◆ Op-Amp/Comparator Outputs Swing Rail-to-Rail
- ◆ Ground-Sensing Inputs for Both Op Amp and Comparator
- ◆ Op Amp Stable with Capacitive Loads up to 250pF
- ◆ Internal  $\pm$ 2mV Comparator Hysteresis
- ◆ Fast 185ns Propagation-Delay Comparator
- ◆ No Phase Reversal for Overdriven Inputs (Both Op Amp and Comparator)
- ◆ Internal 1.230V Precision Reference (MAX9000/MAX9001/MAX9003/MAX9004)
  - $\pm$ 1% Initial Accuracy
  - Low 8ppm/ $^{\circ}$ C Temperature Drift
  - Sink or Source up to 1mA
  - Stable for Capacitive Loads up to 100nF

## Ordering Information

PART	TEMP. RANGE	PIN-PACKAGE
MAX9000EUA	-40 $^{\circ}$ C to +85 $^{\circ}$ C	8 $\mu$ MAX
MAX9000ESA	-40 $^{\circ}$ C to +85 $^{\circ}$ C	8 SO
MAX9001EUB	-40 $^{\circ}$ C to +85 $^{\circ}$ C	10 $\mu$ MAX
MAX9001ESD	-40 $^{\circ}$ C to +85 $^{\circ}$ C	14 SO

Ordering Information continued at end of data sheet.

Pin Configurations and Typical Operating Circuit appear at end of data sheet.

Rail-to-Rail is a registered trademark of Nippon Motorola, Ltd.

## Selector Guide

PART	INTERNAL PRECISION REFERENCE	OP-AMP GAIN STABILITY (V/V)	SHUTDOWN	OP-AMP GAIN BANDWIDTH (MHz)	PIN-PACKAGE
MAX9000	Yes	1	No	1.25	8 SO/ $\mu$ MAX
MAX9001	Yes	1	Yes	1.25	10 $\mu$ MAX, 14 SO
MAX9002	No	1	No	1.25	8 SO/ $\mu$ MAX
MAX9003	Yes	10	No	8	8 SO/ $\mu$ MAX
MAX9004	Yes	10	Yes	8	10 $\mu$ MAX, 14 SO
MAX9005	No	10	No	8	8 SO/ $\mu$ MAX



Maxim Integrated Products 1

For free samples & the latest literature: <http://www.maxim-ic.com>, or phone 1-800-998-8800.  
For small orders, phone 408-737-7600 ext. 3468.

# Low-Power, High-Speed, Single-Supply Op Amp + Comparator + Reference ICs

## ABSOLUTE MAXIMUM RATINGS

Supply Voltage ( $V_{DD}$ to $V_{SS}$ )	-0.3V to +6V	10-Pin $\mu$ MAX (derate 5.6mW/°C above +70°C)	444mW
Voltage Inputs ( $A_{IN-}$ , $C_{IN-}$ )	( $V_{SS} - 0.3V$ ) to ( $V_{DD} + 0.3V$ )	14-Pin SO (derate 8.3mW/°C above +70°C)	667mW
Output Short-Circuit Duration ( $A_{OUT}$ , $C_{OUT}$ , REF)	Continuous to either $V_{SS}$ or $V_{DD}$	Operating Temperature Range	
Continuous Power Dissipation ( $T_A = +70^\circ\text{C}$ )		MAX900_E_ _	-40°C to +85°C
8-Pin SO (derate 5.88mW/°C above +70°C)	471mW	Maximum Junction Temperature	+150°C
8-Pin $\mu$ MAX (derate 4.1mW/°C above +70°C)	330mW	Storage Temperature Range	-65°C to +160°C
		Lead Temperature (soldering, 10sec)	+300°C

Stresses beyond those listed under "Absolute Maximum Ratings" may cause permanent damage to the device. These are stress ratings only, and functional operation of the device at these or any other conditions beyond those indicated in the operational sections of the specifications is not implied. Exposure to absolute maximum rating conditions for extended periods may affect device reliability.

## ELECTRICAL CHARACTERISTICS

( $V_{DD} = +2.5V$  to  $+5.5V$ ,  $V_{SS} = 0$ ,  $\overline{SHDN} = V_{DD}$  (MAX9001/MAX9004 only),  $V_{CM(OP AMP)} = 0$ ,  $V_{AOUT} = V_{DD} / 2$ ,  $V_{CM(COMP)} = 0$  (for MAX9001/MAX9002/MAX9004/MAX9005),  $C_{OUT} = \text{low}$ ,  $I_{OUT(REF)} = 0$ ,  $T_A = T_{MIN}$  to  $T_{MAX}$ , unless otherwise noted. Typical values are at  $V_{DD} = 5V$  and  $T_A = +25^\circ\text{C}$ .)

PARAMETER	SYMBOL	CONDITIONS	MIN	TYP	MAX	UNITS
Supply Voltage Range	$V_{DD}$	Guaranteed by PSRR tests	2.5		5.5	V
Supply Current	$I_{DD}$	MAX9000/MAX9001/ MAX9003/MAX9004	$V_{DD} = 3V$	410	500	$\mu\text{A}$
			$V_{DD} = 5V$	450	550	
		MAX9002/MAX9005	$V_{DD} = 3V$	340	425	$\mu\text{A}$
			$V_{DD} = 5V$	375	475	
Supply Current in Shutdown	$I_{\overline{SHDN}}$	MAX9001/MAX9004 ( $V_{\overline{SHDN}} = 0$ )		2	5	$\mu\text{A}$
Shutdown Input Bias Current	$I_{IN(\overline{SHDN})}$	MAX9001/MAX9004 ( $V_{\overline{SHDN}} = 0$ to $V_{DD}$ )		1	2.5	$\mu\text{A}$
Shutdown Logic High	$V_{IH(\overline{SHDN})}$		$0.7 \times V_{DD}$			V
Shutdown Logic Low	$V_{IL(\overline{SHDN})}$			$0.3 \times V_{DD}$		V
<b>OP AMP</b>						
Input Offset Voltage	$V_{OS}$	MAX900_ES_		$\pm 0.5$	$\pm 1.5$	mV
Input Offset Voltage Temperature Coefficient	$TCV_{OS}$	MAX900_ES_		$\pm 1$		$\mu\text{V}/^\circ\text{C}$
Input Bias Current	$I_{BIAS}$	$A_{IN+}$ , $A_{IN-}$		$\pm 0.05$	$\pm 2$	nA
Input Offset Current		$A_{IN+}$ , $A_{IN-}$		$\pm 0.02$	$\pm 1$	nA
Input Resistance	$R_{IN}$	Differential or common mode		1000		$M\Omega$
Input Common-Mode Voltage Range	CMVR	Guaranteed by CMRR test	-0.15		$V_{DD} - 1.2$	V
Common-Mode Rejection Ratio	CMRR	MAX900_ES_, ( $V_{SS} - 0.15V$ ) $\leq V_{CM} \leq (V_{DD} - 1.2V)$ , $V_{DD} = 5.5V$	72	96		dB
Power-Supply Rejection Ratio	PSRR	$V_{DD} = 2.5V$ to $5.5V$	74	100		dB
Output Resistance		$A_V = 1V/V$		0.01		$\Omega$
Output Short-Circuit Current		Shorted to $V_{SS}$		10		mA
		Shorted to $V_{DD}$		65		
Disabled Mode Output Leakage	$I_{OUT(DISABLED)}$	$V_{\overline{SHDN}} \leq (0.3V \times V_{DD})$ , $V_{AOUT} = 0$ to $V_{DD}$		$\pm 0.01$	$\pm 1$	$\mu\text{A}$

# Low-Power, High-Speed, Single-Supply Op Amp + Comparator + Reference ICs

MAX9000-MAX9005

## ELECTRICAL CHARACTERISTICS (continued)

( $V_{DD} = +2.5V$  to  $+5.5V$ ,  $V_{SS} = 0$ ,  $\overline{SHDN} = V_{DD}$  (MAX9001/MAX9004 only),  $V_{CM(OP\ AMP)} = 0$ ,  $V_{AOUT} = V_{DD} / 2$ ,  $V_{CM(COMP)} = 0$  (for MAX9001/MAX9002/MAX9004/MAX9005),  $C_{OUT} = \text{low}$ ,  $I_{OUT(REF)} = 0$ ,  $T_A = T_{MIN}$  to  $T_{MAX}$ , unless otherwise noted. Typical values are at  $V_{DD} = 5V$  and  $T_A = +25^\circ C$ .)

PARAMETER	SYMBOL	CONDITIONS		MIN	TYP	MAX	UNITS	
Large-Signal Voltage Gain	$A_{VOL}$	$V_{DD} = 2.5V$	$V_{AOUT} = 0.05V$ to $2.45V$ , $R_L = 100k\Omega$	94	125		dB	
			$V_{AOUT} = 0.2V$ to $2.3V$ , $R_L = 1k\Omega$	84	115			
		$V_{DD} = 5.5V$	$V_{AOUT} = 0.05V$ to $5.4V$ , $R_L = 100k\Omega$	94	120			
			$V_{AOUT} = 0.25V$ to $5.2V$ , $R_L = 1k\Omega$	86	106			
Output Voltage Swing	$V_{OL} / V_{OH}$	$ V_{AIN+} - V_{AIN-}  \geq 10mV$	$R_L = 100k\Omega$	$V_{DD} - V_{OH}$		1	5	mV
				$V_{OL}$		1	5	
			$R_L = 1k\Omega$	$V_{DD} - V_{OH}$		140	250	
				$V_{OL}$		60	100	
Gain-Bandwidth Product	GBW	MAX9000/MAX9001/MAX9002			1.25		MHz	
		MAX9003/MAX9004/MAX9005			8			
Phase Margin		MAX9000/MAX9001/MAX9002			75		degrees	
		MAX9003/MAX9004/MAX9005			80			
Gain Margin		MAX9000/MAX9001/MAX9002			30		dB	
		MAX9003/MAX9004/MAX9005			40			
Total Harmonic Distortion plus Noise	THD+N	$f = 10kHz$ , $V_{AOUT} = 2V_{p-p}$ , $V_{DD} = 5V$	MAX9000/MAX9001/ MAX9002 ( $A_V = 1V/V$ )		0.009		%	
			MAX9003/MAX9004/ MAX9005 ( $A_V = 10V/V$ )		0.028			
Slew Rate	SR	$V_{DD} = 5V$ , $V_{AOUT} = 4V$ step	MAX9000/MAX9001/ MAX9002 ( $A_V = 1V/V$ )		0.85		V/ $\mu s$	
			MAX9003/MAX9004/ MAX9005 ( $A_V = 10V/V$ )		6.0			
Settling Time to within 0.01%		$V_{DD} = 5V$ , $V_{AOUT} = 4V$ step	MAX9000/MAX9001/ MAX9002 ( $A_V = 1V/V$ )		6.9		$\mu s$	
			MAX9003/MAX9004/ MAX9005 ( $A_V = 10V/V$ )		2.1			
Input Capacitance	$C_{IN}$				2.5		pF	
Input Noise Voltage Density	$V_{NOISE}$	$f = 10kHz$			36		nV/ $\sqrt{Hz}$	
Input Noise Current Density	$I_{NOISE}$	$f = 10kHz$			1		fA/ $\sqrt{Hz}$	
Shutdown Delay Time					0.2		$\mu s$	
Enable Delay Time					2		$\mu s$	
Power-On Time					2		$\mu s$	
Capacitive-Load Stability	$C_{LOAD}$	MAX9000/MAX9001/MAX9002 ( $A_V = 1V/V$ )			250		pF	
		MAX9003/MAX9004/MAX9005 ( $A_V = 10V/V$ )			250			
<b>COMPARATOR</b>								
Input Offset Voltage	$V_{OS}$	MAX900_ES_ (Notes 1, 2)			$\pm 1$	$\pm 2$	mV	
Input Offset Voltage Temperature Coefficient	$TCV_{OS}$	MAX900_ES_			$\pm 1$		$\mu V/^\circ C$	
Input-Referred Hysteresis		$V_{DD} = 5V$ (Notes 2, 3)			4	7	mV	

# Low-Power, High-Speed, Single-Supply Op Amp + Comparator + Reference ICs

## ELECTRICAL CHARACTERISTICS (continued)

( $V_{DD} = +2.5V$  to  $+5.5V$ ,  $V_{SS} = 0$ ,  $\overline{SHDN} = V_{DD}$  (MAX9001/MAX9004 only),  $V_{CM(OP AMP)} = 0$ ,  $V_{AOUT} = V_{DD} / 2$ ,  $V_{CM(COMP)} = 0$  (for MAX9001/MAX9002/MAX9004/MAX9005),  $C_{OUT} = \text{low}$ ,  $I_{OUT(REF)} = 0$ ,  $T_A = T_{MIN}$  to  $T_{MAX}$ , unless otherwise noted. Typical values are at  $V_{DD} = 5V$  and  $T_A = +25^\circ C$ .)

PARAMETER	SYMBOL	CONDITIONS		MIN	TYP	MAX	UNITS	
Input Bias Current	$I_{BIAS}$				8	80	nA	
Input Offset Current	$I_{OS}$	MAX9001/MAX9002/MAX9004/MAX9005			$\pm 2$	$\pm 15$	nA	
Common-Mode Voltage Range	$V_{CM}$	Guaranteed by CMRR test		$V_{SS} - 0.15$		$V_{DD} - 1.1$	V	
Common-Mode Rejection Ratio	CMRR	MAX9001/MAX9002/MAX9004/MAX9005, $0.15V \leq V_{CM} \leq (V_{DD} - 1.1V)$ , $V_{DD} = 5.5V$		72	100		dB	
Power-Supply Rejection Ratio	PSRR	$V_{DD} = 2.5V$ to $5.5V$		72	100		dB	
Output Voltage Swing	$V_{OL}/V_{OH}$	$(V_{CIN+} - V_{CIN-}) \geq 20mV$	$V_{DD} - V_{OH}$	$I_{SOURCE} = 10\mu A$	5		mV	
				$I_{SOURCE} = 4mA$	400			
			$V_{OL}$	$I_{SINK} = 10\mu A$		5		
				$I_{SINK} = 4mA$				400
Output Short-Circuit Current					55		mA	
Disabled Mode Output Leakage	$I_{OUT (DISABLED)}$	$V_{\overline{SHDN}} \leq (0.3V \times V_{DD})$ , $V_{COUT} = 0$ to $V_{DD}$			$\pm 0.01$	$\pm 1$	$\mu A$	
Propagation Delay	$t_{PD+}$ , $t_{PD-}$	$V_{OD} = 25mV$ , $R_L = 10k\Omega$ , $C_L = 15pF$ (Note 4)			185		ns	
Rise/Fall Time	$t_R$ , $t_F$	$V_{DD} = 5V$ , $R_L = 10k\Omega$ , $C_L = 15pF$ (Note 5)			10		ns	
Shutdown Delay Time					100		ns	
Enable Delay Time					100		ns	
Power-On Time					100		ns	
<b>VOLTAGE REFERENCE (MAX9000/MAX9001/MAX9003/MAX9004)</b>								
Output Voltage	$V_{REF}$	MAX900_ES_, $V_{DD} = 5V$ , $T_A = +25^\circ C$		1.218	1.230	1.242	V	
Output Voltage Temperature Coefficient	$TCV_{REF}$				8		ppm/ $^\circ C$	
Line Regulation		$V_{DD} = 2.5V$ to $5.5V$			20	250	$\mu V/V$	
Load Regulation		$V_{DD} = 5V$ , $I_{OUT} = 0$ to $1mA$	Sourcing		0.15	0.8	mV/mA	
			Sinking		0.6	2.0	mV/mA	
Output Short-Circuit Current		Shorted to $V_{SS}$			6		mA	
		Shorted to $V_{DD}$			10			
Disabled Mode Output Leakage		$V_{\overline{SHDN}} \leq (0.3V \times V_{DD})$ , $V_{REF} = 0$ to $V_{DD}$			$\pm 0.01$	$\pm 1$	$\mu A$	
Output Noise		0.1Hz to 10Hz			20		$\mu V_{p-p}$	
Shutdown Delay Time					1		$\mu s$	
Enable Delay Time		$R_L = 100k\Omega$ to $V_{SS}$ , $V_{REF}$ within 1%			16		$\mu s$	
Power-On Time		$R_L = 100k\Omega$ to $V_{SS}$ , $V_{REF}$ within 1%			16		$\mu s$	
Capacitive Load Stability					0 to 100		nF	

**Note 1:** Comparator Input Offset is defined as the center of the input-referred hysteresis zone.

**Note 2:** Measured at  $V_{CM(COMP)} = 0$  for the MAX9001/MAX9002/MAX9004/MAX9005; or  $V_{CM(COMP)} = V_{REF}$  for the MAX9000/MAX9003.

**Note 3:** Input-referred hysteresis is defined as the difference of the trip points required to change comparator output states.

**Note 4:**  $V_{OD}$  is the overdrive that is beyond the offset and hysteresis-determined trip points.

**Note 5:** Rise and fall times are measured between 10% and 90% at  $C_{OUT}$ .

# Low-Power, High-Speed, Single-Supply Op Amp + Comparator + Reference ICs

## Typical Operating Characteristics

( $V_{DD} = +5V$ ,  $V_{SS} = 0$ ,  $V_{CM}$  (op amp) = 0,  $\overline{SHDN} = V_{DD}$ ,  $C_{OUT} = \text{low}$ ,  $R_L = \infty$ ,  $T_A = +25^\circ\text{C}$ , unless otherwise noted.)

MAX9000-MAX9005



# Low-Power, High-Speed, Single-Supply Op Amp + Comparator + Reference ICs

## Typical Operating Characteristics (continued)

( $V_{DD} = +5V$ ,  $V_{SS} = 0$ ,  $V_{CM}(\text{op amp}) = 0$ ,  $\overline{\text{SHDN}} = V_{DD}$ ,  $\text{COUT} = \text{low}$ ,  $R_L = \infty$ ,  $T_A = +25^\circ\text{C}$ , unless otherwise noted.)

**CHANGE IN OP-AMP OFFSET VOLTAGE ( $V_{OS}$ ) vs. SUPPLY VOLTAGE**



**CHANGE IN OP-AMP OFFSET VOLTAGE ( $V_{OS}$ ) vs. TEMPERATURE**



**OP-AMP COMMON-MODE REJECTION RATIO vs. TEMPERATURE**



**OP-AMP LARGE-SIGNAL GAIN vs. OUTPUT VOLTAGE**



**OP-AMP LARGE-SIGNAL GAIN vs. OUTPUT VOLTAGE**



**OP-AMP LARGE-SIGNAL GAIN vs. TEMPERATURE**



**OP-AMP LARGE-SIGNAL GAIN vs. OUTPUT VOLTAGE**



**OP-AMP LARGE-SIGNAL GAIN vs. OUTPUT VOLTAGE**



**OP-AMP LARGE-SIGNAL GAIN vs. TEMPERATURE**



# Low-Power, High-Speed, Single-Supply Op Amp + Comparator + Reference ICs

MAX9000-MAX9005

## Typical Operating Characteristics (continued)

( $V_{DD} = +5V$ ,  $V_{SS} = 0$ ,  $V_{CM}$  (op amp) = 0,  $\overline{SHDN} = V_{DD}$ ,  $C_{OUT} = \text{low}$ ,  $R_L = \infty$ ,  $T_A = +25^\circ\text{C}$ , unless otherwise noted.)

**MAX9000/MAX9001/MAX9002**  
OP-AMP GAIN AND PHASE  
vs. FREQUENCY (NO LOAD)



**MAX9000/MAX9001/MAX9002**  
OP-AMP GAIN AND PHASE  
vs. FREQUENCY (WITH  $C_{LOAD}$ )

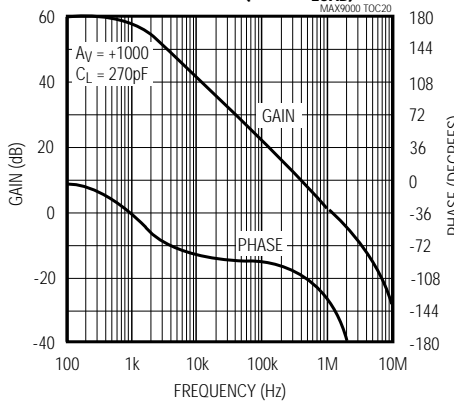

**MAX9000/MAX9001/MAX9002**  
OP-AMP POWER-SUPPLY REJECTION  
vs. FREQUENCY

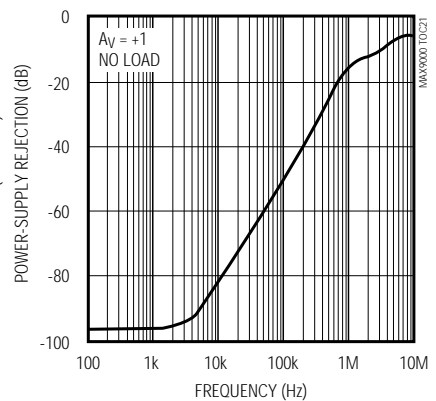

**MAX9003/MAX9004/MAX9005**  
OP-AMP GAIN AND PHASE  
vs. FREQUENCY (NO LOAD)



**MAX9003/MAX9004/MAX9005**  
OP-AMP GAIN AND PHASE  
vs. FREQUENCY (WITH  $C_{LOAD}$ )

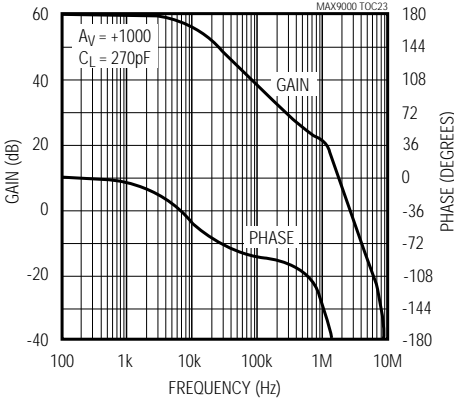

**MAX9003/MAX9004/MAX9005**  
OP-AMP POWER-SUPPLY REJECTION  
vs. FREQUENCY

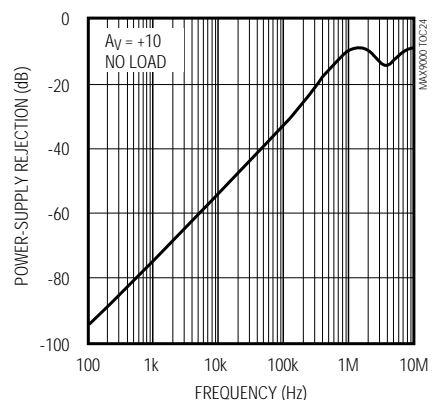

**MAX9000/MAX9001/MAX9002**  
OP-AMP PERCENT OVERSHOOT  
vs. LOAD CAPACITANCE



**MAX9003/MAX9004/MAX9005**  
OP-AMP PERCENT OVERSHOOT  
vs. LOAD CAPACITANCE



**OP-AMP VOLTAGE NOISE DENSITY  
vs. FREQUENCY**



# Low-Power, High-Speed, Single-Supply Op Amp + Comparator + Reference ICs

## Typical Operating Characteristics (continued)

( $V_{DD} = +5V$ ,  $V_{SS} = 0$ ,  $V_{CM}$  (op amp) = 0,  $\overline{SHDN} = V_{DD}$ ,  $C_{OUT} = \text{low}$ ,  $R_L = \infty$ ,  $T_A = +25^\circ\text{C}$ , unless otherwise noted.)

**MAX9000/MAX9001/MAX9002  
OP-AMP TOTAL HARMONIC DISTORTION PLUS NOISE vs. FREQUENCY**



**MAX9000/MAX9001/MAX9002  
OP-AMP TOTAL HARMONIC DISTORTION PLUS NOISE vs. VAOUT**



**MAX9000/MAX9001/MAX9002  
OP-AMP OUTPUT IMPEDANCE vs. FREQUENCY**



**MAX9003/MAX9004/MAX9005  
OP-AMP TOTAL HARMONIC DISTORTION PLUS NOISE vs. FREQUENCY**



**MAX9003/MAX9004/MAX9005  
OP-AMP TOTAL HARMONIC DISTORTION PLUS NOISE vs. VAOUT**



**MAX9003/MAX9004/MAX9005  
OP-AMP OUTPUT IMPEDANCE vs. FREQUENCY**



**CHANGE IN COMPARATOR OFFSET VOLTAGE (VOS) vs. SUPPLY VOLTAGE**



**CHANGE IN COMPARATOR OFFSET VOLTAGE (VOS) vs. TEMPERATURE**



**COMPARATOR COMMON-MODE REJECTION RATIO (CMRR) vs. TEMPERATURE**

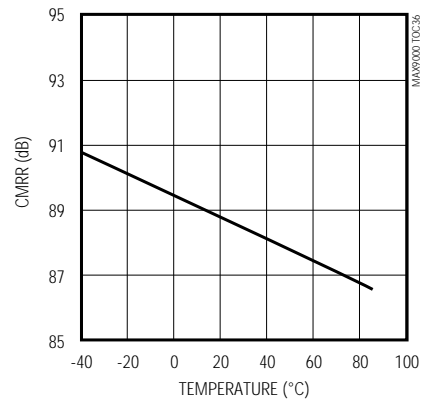



# Low-Power, High-Speed, Single-Supply Op Amp + Comparator + Reference ICs

MAX9000-MAX9005

## Typical Operating Characteristics (continued)

( $V_{DD} = +5V$ ,  $V_{SS} = 0$ ,  $V_{CM}(\text{op amp}) = 0$ ,  $\overline{\text{SHDN}} = V_{DD}$ ,  $C_{OUT} = \text{low}$ ,  $R_L = \infty$ ,  $T_A = +25^\circ\text{C}$ , unless otherwise noted.)

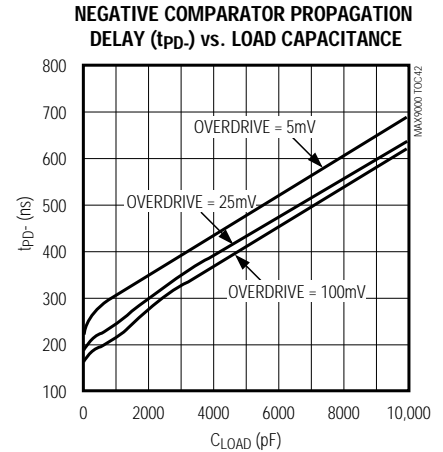
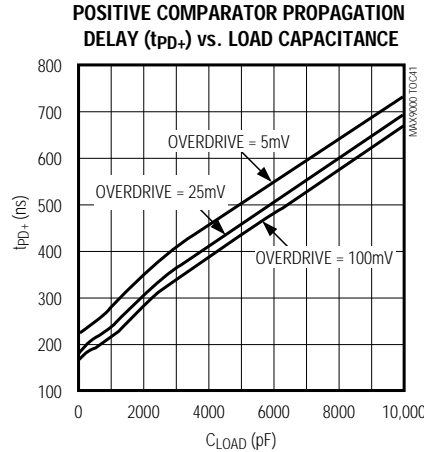
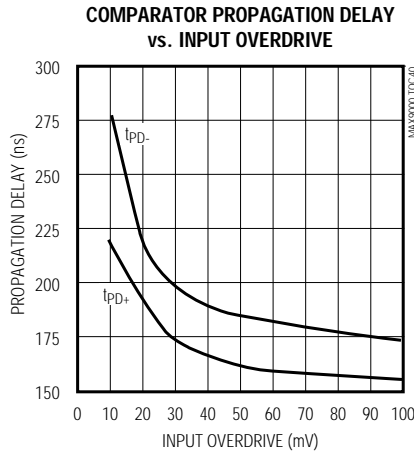
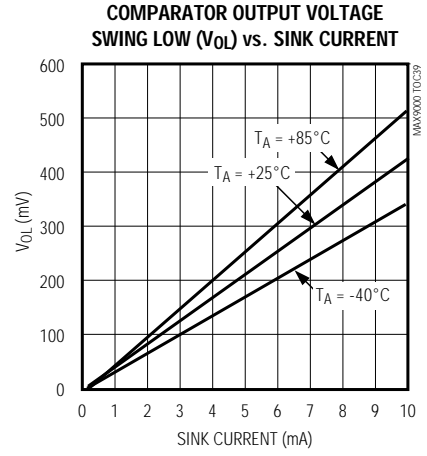
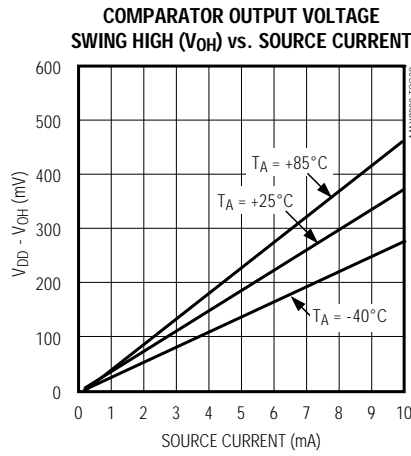
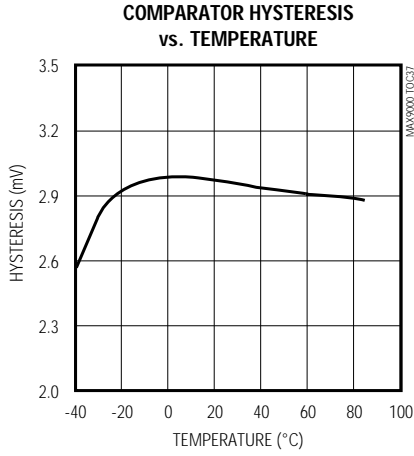

# Low-Power, High-Speed, Single-Supply Op Amp + Comparator + Reference ICs

## Typical Operating Characteristics (continued)

( $V_{DD} = +5V$ ,  $V_{SS} = 0$ ,  $V_{CM}$  (op amp) = 0,  $\overline{SHDN} = V_{DD}$ ,  $C_{OUT} = \text{low}$ ,  $R_L = \infty$ ,  $T_A = +25^\circ\text{C}$ , unless otherwise noted.)

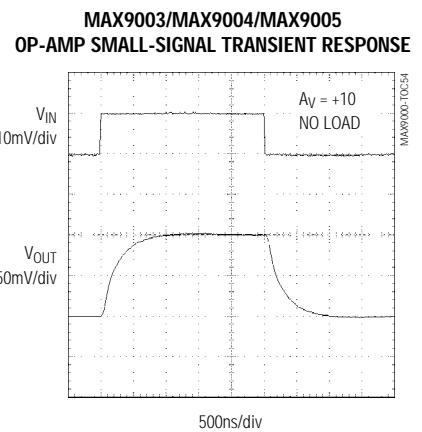
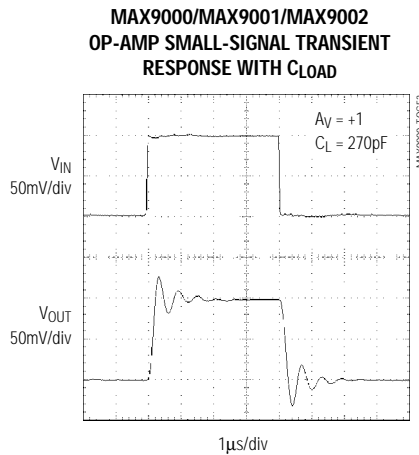
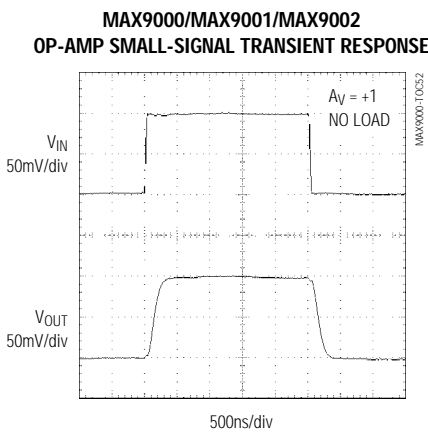
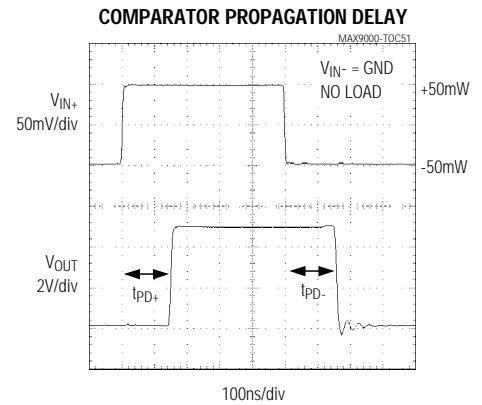
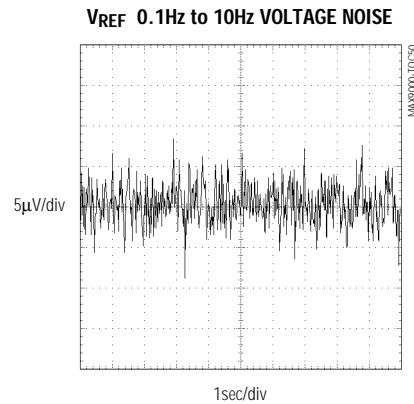
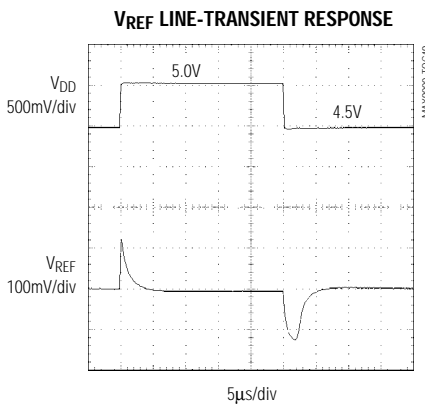
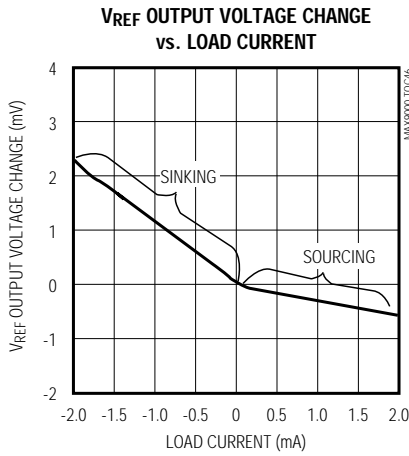

# Low-Power, High-Speed, Single-Supply Op Amp + Comparator + Reference ICs

MAX9000-MAX9005

## Typical Operating Characteristics (continued)

( $V_{DD} = +5V$ ,  $V_{SS} = 0$ ,  $V_{CM}$  (op amp) = 0,  $\overline{SHDN} = V_{DD}$ ,  $C_{OUT} = \text{low}$ ,  $R_L = \infty$ ,  $T_A = +25^\circ\text{C}$ , unless otherwise noted.)

**MAX9003/MAX9004/MAX9005  
OP-AMP SMALL-SIGNAL TRANSIENT  
RESPONSE WITH  $C_{LOAD}$**



**MAX9000/MAX9001/MAX9002  
OP-AMP LARGE-SIGNAL TRANSIENT RESPONSE**



**MAX9003/MAX9004/MAX9005  
OP-AMP LARGE-SIGNAL TRANSIENT RESPONSE**



## Pin Description

PIN				NAME	FUNCTION
MAX9000/ MAX9003	MAX9002/ MAX9005	MAX9001/MAX9004			
		10 $\mu$ MAX	14 SO		
—	—	1	2	$\overline{SHDN}$	Shutdown Logic Input
1	1	2	3	AOUT	Op-Amp Output
2	2	3	4	AIN-	Inverting Op-Amp Input
3	3	4	5	AIN+	Noninverting Op-Amp Input
4	4	5	6	$V_{SS}$	Negative Supply or Ground
5	—	6	9	REF	Internal Reference Output
—	5	7	10	CIN-	Inverting Comparator Input
6	6	8	11	CIN+	Noninverting Comparator Input
7	7	9	12	COUT	Comparator Output
8	8	10	13	$V_{DD}$	Positive Supply
—	—	—	1, 7, 8, 14	N.C.	No Connection. Not internally connected.

# Low-Power, High-Speed, Single-Supply Op Amp + Comparator + Reference ICs

## Detailed Description

The MAX9001-MAX9005 are combinations of a high-speed operational amplifier, a 185ns comparator, and a 1%-accurate, 8ppm/°C, 1.230V reference. The devices are offered in space-saving 8-pin and 10-pin  $\mu$ MAX packages. The comparator's inverting input is internally connected to the reference output in the MAX9000/MAX9003. The MAX9002/MAX9005 do not have an internal reference, but the inverting input of the comparator is available externally. The MAX9001/MAX9004 include both the inverting input and the reference output. The MAX9000/MAX9001/MAX9003/MAX9004 typically consume only 410 $\mu$ A of quiescent current, while the MAX9002/MAX9004 typically consume 340 $\mu$ A. These low-power, Rail-to-Rail devices provide excellent AC and DC performance and are ideally suited to operate from a single supply. The MAX9001/MAX9004 feature a shutdown mode that sets the outputs in a high-impedance state and reduces the supply current to 2 $\mu$ A, making these devices ideal for portable and battery-powered systems.

### Op Amp

The op amps in the MAX9000/MAX9001/MAX9002 are unity-gain stable with a gain-bandwidth product of 1.25MHz and a slew rate of 0.85V/ $\mu$ s. The amplifiers in the MAX9003/MAX9004/MAX9005 are stable at closed-loop gains greater than or equal to 10V/V, with a gain-bandwidth product of 8MHz and a slew rate of 6.0V/ $\mu$ s.

The common-mode input voltage range extends from 150mV below the negative rail to within 1.2V of the positive rail. The amplifier output does not undergo phase reversal when the common-mode input range is exceeded, and the input impedance is relatively constant for input voltages within both supply rails. The MOS differential inputs of the amplifiers feature extremely high input impedance and ultra-low input bias currents. The CMOS output stage achieves true rail-to-rail operation; the outputs swing to within a few millivolts of the supply rails, thus extending the dynamic range. A proprietary design achieves high open-loop gain, enabling these devices to operate at low quiescent currents yet maintain excellent DC and AC characteristics under various load conditions. These devices have been designed to maintain low offset voltage over the entire operating-temperature, common-mode, and supply-voltage ranges.



Figure 1. MAX9000-MAX90005 Functional Diagrams

# Low-Power, High-Speed, Single-Supply Op Amp + Comparator + Reference ICs

## Comparator

The common-mode input range extends from 150mV below the negative rail to within 1.1V of the positive rail. The bipolar differential inputs of the comparator feature high input impedance and low input bias currents. The comparators are designed to maintain low offset voltage over the entire operating-temperature, common-mode, and supply-voltage ranges. In the MAX9000/MAX9003, the comparator's inverting input is internally connected to the reference output.

The CMOS output stage achieves true rail-to-rail operation; the outputs swing to within a few millivolts of the supply rails. The comparator's propagation delay is 185ns and is a function of the overdrive (see *Typical Operating Characteristics*). TTL/CMOS compatibility is maintained even with a  $\pm 4$ mA output load. A proprietary design of the output stage substantially reduces the cross-conduction current during output transitions, thereby minimizing power-supply glitches typical of most comparators. In addition, the comparator's  $\pm 2$ mV of built-in hysteresis provides noise immunity and prevents unstable outputs even with slow-moving input signals.

## Voltage Reference

The 1%-accurate, precision 1.230V internal bandgap reference in the MAX9000/MAX9001/MAX9003/MAX9004 achieves an 8ppm/ $^{\circ}$ C temperature coefficient (tempco). The reference can sink or source 1mA of load current with excellent load regulation. The output typically changes only 60 $\mu$ V for a 3V change in input voltage (line regulation). The reference is stable for capacitive loads up to 100nF.

## Applications Information

The MAX9000-MAX9005 offer excellent performance and low power consumption, and are available in space-saving  $\mu$ MAX packages. The following section provides some practical application guidelines.

### Bypassing and Layout

The MAX9000-MAX9005 operate from a +2.5V to +5.5V single supply or from  $\pm 1.25$ V to  $\pm 2.75$ V dual supplies. (In the MAX9000/MAX9001/MAX9003/MAX9004, the reference voltage is referred to as  $V_{SS}$ .) For single-supply operation, bypass the power supply with a 0.1 $\mu$ F capacitor. For dual supplies, bypass each supply to ground. Bypass with capacitors as close as possible to the device to minimize lead inductance and noise. Use a low-inductance ground plane if possible. A printed circuit board with a ground plane is recommended. Avoid using wire-wrap boards, breadboards, or IC sockets. For heavy loads at the comparator's and/or

amplifier's output, add a 1 $\mu$ F to 10 $\mu$ F power-supply bypass capacitor.

The device has a high degree of isolation between the various blocks. To maintain isolation, careful layout is required. Take special precautions to avoid crossing signal traces, especially from the outputs to the inputs. For sensitive applications, shielding might be required. In addition, stray capacitance may affect the stability and frequency response of the amplifier. Decrease stray capacitance by minimizing lead lengths in the board layout, as well as placing external components as close to the device as possible.

### Op-Amp Frequency Stability

Driving large capacitive loads can cause instability in most low-power, rail-to-rail output amplifiers. These amplifiers are stable with capacitive loads up to 250pF in their minimum gain configuration. Stability with higher capacitive loads can be improved by adding an isolation resistor in series with the op-amp output, as shown in Figure 2. This resistor improves the circuit's phase margin by isolating the load capacitor from the amplifier's output. Figures 3 and 4 show the response of the amplifier with and without an isolation resistor, respectively.

The total capacitance at the op amp's inputs (input capacitance + stray capacitance) along with large-value feedback resistors can cause additional poles within the amplifier's bandwidth, thus degrading the phase margin. To compensate for this effect, place a 2pF to 10pF capacitor across the feedback resistor, as shown in Figure 5.



Figure 2. Isolation Resistors to Drive Capacitive Loads

# Low-Power, High-Speed, Single-Supply Op Amp + Comparator + Reference ICs

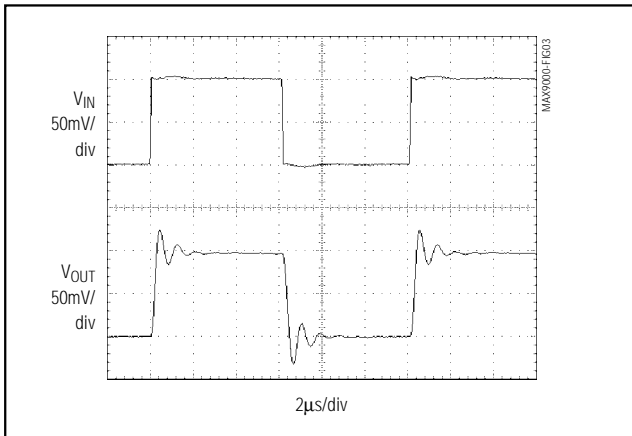

Figure 3. MAX9000/MAX9001/MAX9002 Op-Amp Small-Signal Transient Response with Capacitive Load ( $C_L = 510\text{pF}$ ) and Isolation Resistor ( $R_{ISO} = 91\Omega$ )

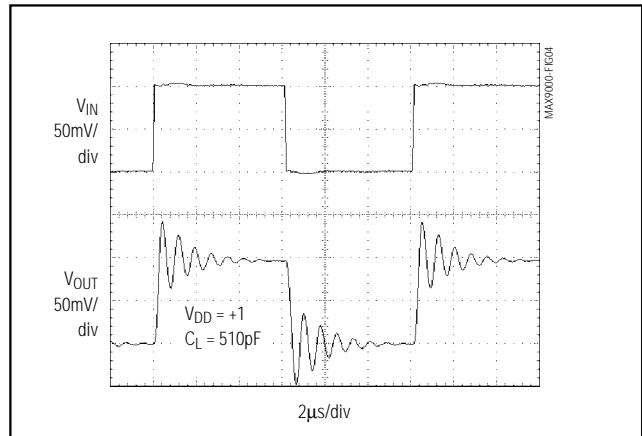

Figure 4. MAX9000/MAX9001/MAX9002 Op-Amp Small-Signal Transient Response with Capacitive Load ( $C_L = 510\text{pF}$ ) and No Isolation Resistor

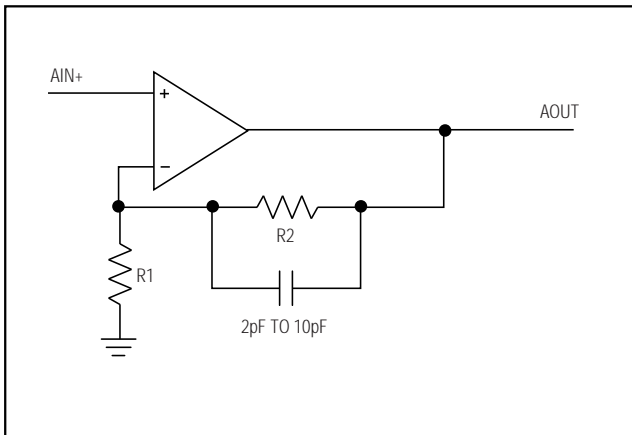

Figure 5. Compensation for Input Capacitance

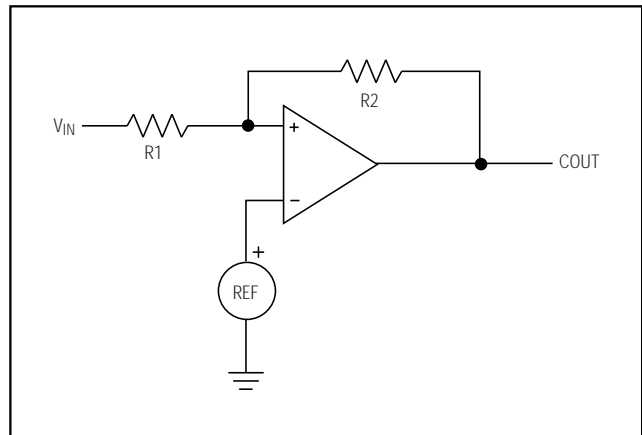

Figure 6. External Hysteresis

## Reference Bypassing

While the internal reference is stable with capacitive loads up to 100nF, it does not require an output capacitor for stability. However, in applications where the load or the supply could experience large step changes, an output capacitor reduces the amount of overshoot and improves the circuit's transient response.

## Comparator Input Stage

The comparator's input bias current is typically 8nA. To reduce the offset error caused by the bias current flowing through the external source impedance, match the effective impedance seen by each input. High source impedance together with the comparator's input capacitance can increase the propagation delay through the

comparator. The outputs do not undergo phase reversal when the input common-mode range is exceeded, and the input impedance is relatively constant for input voltages within both supply rails.

## Comparator Hysteresis

Built-in  $\pm 2\text{mV}$  hysteresis improves the comparator's noise immunity. It prevents unstable outputs with slow-moving or noisy input signals. If additional hysteresis is required, add positive feedback as shown in Figure 6. This configuration increases the hysteresis band to desired levels, but also increases power consumption and slows down the output response.

# Low-Power, High-Speed, Single-Supply Op Amp + Comparator + Reference ICs

To add hysteresis, use the following procedure:

**Step 1:** The device's input bias current can be as high as 80nA. To minimize error due to the input bias, choose a value for R2 of 100kΩ ( $V_{REF} / R2$ ), which allows a current of 12.33μA at the upper trip point.

**Step 2:** Choose the width of the hysteresis band. In this example, choose 20mV for the added external hysteresis ( $V_{EHYST} = 20mV$ ). Total hysteresis =  $V_{EHYST} + V_{IHYST} = 24mV$ .

$$R1 = R2 (V_{EHYST} - 2V_{IHYST}) / (V_{DD} + 2V_{IHYST})$$

where  $I_{HYST}$  is the device's internal hysteresis.

**Step 3:** Determine R1. If  $V_{DD} = 5V$ , then  $R1 = 319\Omega$ .

**Step 4:** Check the hysteresis trip points. The following equation represents the upper trip point ( $V_{IN(H)}$ ):

$$V_{IN(H)} = [(R1 + R2) / R2] (V_{REF} + V_{IHYST}) = 1.238V$$

The lower trip point is 24mV lower than upper trip point.  $V_{IN(L)} = 1.238V - 0.024V = 1.214V$ .

## Comparator Propagation Delay

The comparator's propagation delay is a function of the input overdrive voltage. Overdrive voltage is measured from beyond the edge of the offset and hysteresis-determined trip points (see *Typical Operating Characteristics* for a graph of Propagation Delay vs. Input Overdrive). High source impedance coupled with the comparator's input capacitance increases the propagation delay. Large capacitive loads also increase the propagation delay.

## Shutdown ( $\overline{SHDN}$ )

Shutdown is active-low enabled. The  $\overline{SHDN}$  input for the MAX9001/MAX9004 can be taken above the posi-



Figure 7. Enable/Disable Response of Op Amp, Comparator, and Reference to  $\overline{SHDN}$

tive supply without an increase in the  $\overline{SHDN}$  input current, allowing them to be driven from independent logic circuits powered from a different supply voltage. However, the logic threshold voltage requirements must be met for proper operation. If  $\overline{SHDN}$  is left unconnected, the device defaults to the enabled mode through an internal 4MΩ pull-up to  $V_{DD}$ . If  $\overline{SHDN}$  is to be left unconnected, take proper care to ensure that no signals are coupled to this pin, as this may cause false triggering.

In shutdown mode, all outputs are set to a high-impedance state and the supply current reduces to 2μA. Enable times for the op amp, comparator, and reference are 2μs, 100ns, and 16μs, respectively. Shutdown delay times for the op amp, comparator, and reference are 200ns, 100ns, and 1μs, respectively (Figure 7).

## Application Circuits

### Radio Receiver for Alarms and Detectors

Figure 8's circuit is useful as a front end for RF alarms. An unshielded inductor is used with capacitors C1A, C1B, and C1C in a resonant circuit to provide frequency selectivity. The op amp from a MAX9003 amplifies the signal received. The comparator improves noise immunity, provides a signal-strength threshold, and translates the received signal into a pulse train. The tuned LC circuit in Figure 8 is set for 300kHz. The layout and routing of components for the amplifier should be tight to minimize 60Hz interference and crosstalk from the comparator. Metal shielding is recommended to prevent RFI from the comparator or digital circuitry from exciting the receiving antenna. The transmitting



Figure 8. Radio Receiver Application

## Low-Power, High-Speed, Single-Supply Op Amp + Comparator + Reference ICs

antenna can be long parallel wires spaced about 7.2cm apart, with equal but opposite currents. Radio waves from this antenna are detectable when the receiver is brought within close proximity, but cancel out at greater distances.

### Infrared Receiver Front End for Remote Controls and Data Links

The circuit in Figure 9 uses the MAX9003 as a PIN photodiode preamplifier and discriminator for an infrared receiver. The op amp is configured as a Delyiannis-noise and eliminates low-frequency interference from sunlight, fluorescent lights, etc. This circuit is applicable for TV remote controls and low-frequency data links up to 200kbps. Carrier frequencies are limited to around 100kHz, as in the example circuit. Component layout and routing for the amplifier should be tight to reduce stray capacitance, 60Hz interference, and RFI from the comparator. Crosstalk from comparator edges distorts the amplifier signal. To minimize this effect, add a lowpass RC filter to the connection from the reference to the op amp's noninverting input.

### Signal Conditioning

For incoming signals that require filtering, the internal amplifier provides an opportunity to create an active filter. This may be required for relatively high-speed signals that require adequate filtering of high-speed carrier frequencies, harmonics, and external noise. In addition, the amplifier can be used to amplify the signal prior to digitizing it through the comparator to improve the comparator's overall output response and improve its noise immunity.



Figure 9. Infrared Receiver Application



# Low-Power, High-Speed, Single-Supply Op Amp + Comparator + Reference ICs

## Pin Configurations

MAX9000-MAX9005



## Typical Operating Circuit



# Low-Power, High-Speed, Single-Supply Op Amp + Comparator + Reference ICs

## Ordering Information (continued)

PART	TEMP. RANGE	PIN-PACKAGE
<b>MAX9002</b> EUA	-40°C to +85°C	8 $\mu$ MAX
MAX9002ESA	-40°C to +85°C	8 SO
<b>MAX9003</b> EUA	-40°C to +85°C	8 $\mu$ MAX
MAX9003ESA	-40°C to +85°C	8 SO
<b>MAX9004</b> EUB	-40°C to +85°C	10 $\mu$ MAX
MAX9004ESD	-40°C to +85°C	14 SO
<b>MAX9005</b> EUA	-40°C to +85°C	8 $\mu$ MAX
MAX9005ESA	-40°C to +85°C	8 SO

## Chip Information

TRANSISTOR COUNT: 283

## Package Information

	INCHES		MILLIMETERS	
	MIN	MAX	MIN	MAX
A	0.036	0.044	0.91	1.11
A1	0.004	0.008	0.10	0.20
B	0.010	0.014	0.25	0.36
C	0.005	0.007	0.13	0.18
D	0.116	0.120	2.95	3.05
e	0.0256		0.65	
E	0.116	0.120	2.95	3.05
H	0.188	0.198	4.78	5.03
L	0.016	0.026	0.41	0.66
$\alpha$	0°	6°	0°	6°

NOTES:  
 1. D&E DO NOT INCLUDE MOLD FLASH.  
 2. MOLD FLASH OR PROTRUSIONS NOT TO EXCEED .15mm(.006").  
 3. CONTROLLING DIMENSION: INCHES

8LUMXKD:EPS

<b>MAXIM</b>		
PROPRIETARY INFORMATION		
TITLE: 8LD $\mu$ MAX PACKAGE OUTLINE DWG.		
APPROVAL	DOCUMENT CONTROL NO. 21-0036	REV D 1/1

# Low-Power, High-Speed, Single-Supply Op Amp + Comparator + Reference ICs

## Package Information (continued)

MAX9000-MAX9005

10LUMAXB.EPS



DIM	INCHES		MILLIMETERS	
	MIN	MAX	MIN	MAX
A	0.037	0.043	0.939	1.092
A1	0.002	0.006	0.051	0.152
A2	0.030	0.038	0.762	0.965
D1	0.112	0.124	2.845	3.150
D2	0.110	0.122	2.794	3.099
E1	0.112	0.124	2.845	3.150
E2	0.110	0.122	2.794	3.099
E	0.185	0.201	4.699	5.105
L	0.0155	0.0275	0.394	0.699
L1	0.037	REF	0.940	REF
b	0.007	0.0106	0.177	0.270
e	0.0197	BSC	.500	BSC
c	0.0035	0.0078	0.090	0.200
S	0.0196	REF	.498	REF
$\alpha$	0°	6°	0°	6°

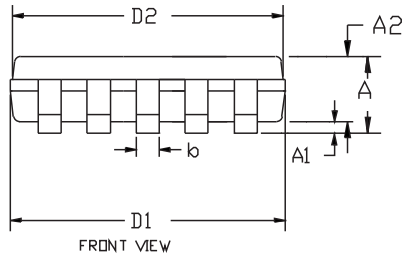

**NOTES:**

1. D&E DO NOT INCLUDE MOLD FLASH.
2. MOLD FLASH OR PROTRUSIONS NOT TO EXCEED .15mm(.006").
3. CONTROLLING DIMENSION: INCHES

<b>MAXIM</b>			
<small>PROPRIETARY INFORMATION</small>			
<small>TITLE:</small>			
PACKAGE OUTLINE, 10L MICRO MAX			
<small>APPROVAL</small>	<small>DOCUMENT CONTROL NO.</small>	<small>REV</small>	<small>1/1</small>
	21-0061	B	

# Low-Power, High-Speed, Single-Supply Op Amp + Comparator + Reference ICs

Package Information (continued)



	INCHES		MILLIMETERS	
	MIN	MAX	MIN	MAX
A	0.053	0.069	1.35	1.75
A1	0.004	0.010	0.10	0.25
B	0.014	0.019	0.35	0.49
C	0.007	0.010	0.19	0.25
e	0.050		1.27	
E	0.150	0.157	3.80	4.00
H	0.228	0.244	5.80	6.20
h	0.010	0.020	0.25	0.50
L	0.016	0.050	0.40	1.27

D	INCHES		MILLIMETERS		N	MS012
	MIN	MAX	MIN	MAX		
D	0.189	0.197	4.80	5.00	8	A
D	0.337	0.344	8.55	8.75	14	B
D	0.386	0.394	9.80	10.00	16	C

- NOTES:
1. D&E DO NOT INCLUDE MOLD FLASH
  2. MOLD FLASH OR PROTRUSIONS NOT TO EXCEED .15mm (.006")
  3. LEADS TO BE COPLANAR WITHIN .102mm (.004")
  4. CONTROLLING DIMENSION: MILLIMETER
  5. MEETS JEDEC MS012-XX AS SHOWN IN ABOVE TABLE
  6. N = NUMBER OF PINS

 <small>120 SAN GABRIEL DR. SUNNYVALE, CA 94086 FAX (408) 737-7704</small> <small>PROPRIETARY INFORMATION</small>	PACKAGE FAMILY OUTLINE: SOIC .150"		21-0041	A
			DOCUMENT CONTROL NUMBER	REV

Maxim cannot assume responsibility for use of any circuitry other than circuitry entirely embodied in a Maxim product. No circuit patent licenses are implied. Maxim reserves the right to change the circuitry and specifications without notice at any time.

20 \_\_\_\_\_ Maxim Integrated Products, 120 San Gabriel Drive, Sunnyvale, CA 94086 408-737-7600

## Данный компонент на территории Российской Федерации

### Вы можете приобрести в компании MosChip.

Для оперативного оформления запроса Вам необходимо перейти по данной ссылке:

<http://moschip.ru/get-element>

Вы можете разместить у нас заказ для любого Вашего проекта, будь то серийное производство или разработка единичного прибора.

В нашем ассортименте представлены ведущие мировые производители активных и пассивных электронных компонентов.

Нашей специализацией является поставка электронной компонентной базы двойного назначения, продукции таких производителей как XILINX, Intel (ex.ALTERA), Vicor, Microchip, Texas Instruments, Analog Devices, Mini-Circuits, Amphenol, Glenair.

Сотрудничество с глобальными дистрибьюторами электронных компонентов, предоставляет возможность заказывать и получать с международных складов практически любой перечень компонентов в оптимальные для Вас сроки.

На всех этапах разработки и производства наши партнеры могут получить квалифицированную поддержку опытных инженеров.

Система менеджмента качества компании отвечает требованиям в соответствии с ГОСТ Р ИСО 9001, ГОСТ РВ 0015-002 и ЭС РД 009

### Офис по работе с юридическими лицами:

105318, г.Москва, ул.Щербаковская д.3, офис 1107, 1118, ДЦ «Щербаковский»

Телефон: +7 495 668-12-70 (многоканальный)

Факс: +7 495 668-12-70 (доб.304)

E-mail: [info@moschip.ru](mailto:info@moschip.ru)

Skype отдела продаж:

moschip.ru

moschip.ru\_4

moschip.ru\_6

moschip.ru\_9