

BILLIE-B

Asymmetric beam for wall-washing. Assembly with holder and installation tape.

TECHNICAL SPECIFICATIONS:

Dimensions	Ø 21.5 mm
Height	16.1 mm
Fastening	pin, tape
ROHS compliant	yes ⓘ

MATERIAL SPECIFICATIONS:

Component	Type	Material	Colour	Finish
BILLIE-B	Single lens	PMMA	clear	
BILLIE-HLD-PIN-TAPE	Holder	PC	white	
HEIDI-TAPE	Tape	PU tape	black	



ORDERING INFORMATION:

Component		Qty in box	MOQ	MPQ	Box weight (kg)
FCA14295_BILLIE-B	Single lens	1792	336	112	0.0
» Box size: 480 x 280 x 300 mm					

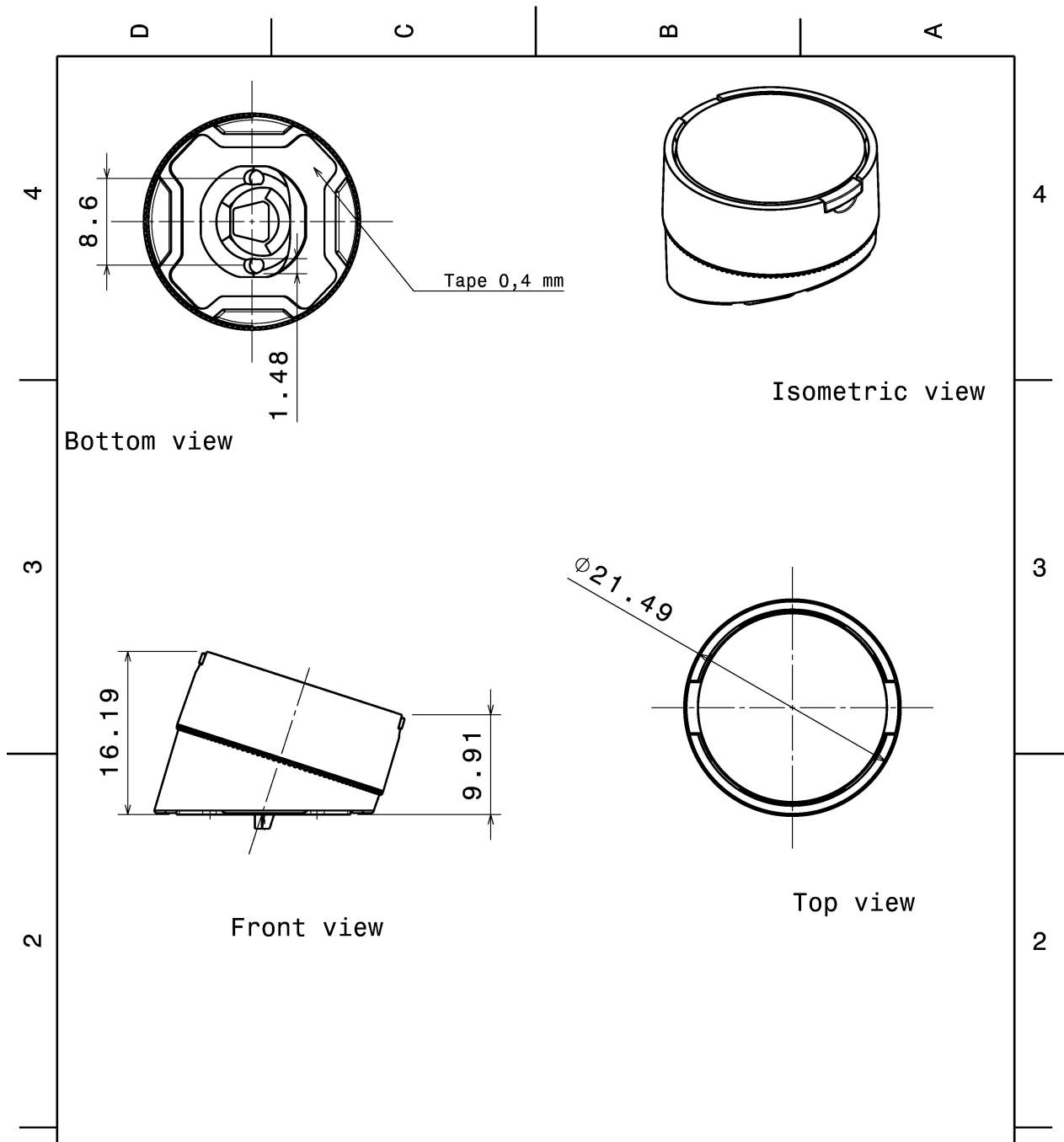

Tolerances if not otherwise shown
According to DIN ISO 2768-1
Linear measures:
Up to 30mm class M, otherwise class C.
According to DIN ISO 2768-2
Form and position: class L

LEDiL

Ledil Oy
Salorankatu 10
FIN 24240 SALO
Finland

THIRD ANGLE PROJECTION:

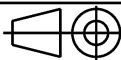

DRAWING TITLE

BILLIE datasheet

This drawing is the property of LEDiL Oy. It may not be reproduced, copied or communicated without a written agreement with LEDiL Oy."

SIZE PART NUMBER

A4

SCALE 2:1 WEIGHT -

SHEET 1/1

PHOTOMETRIC DATA (MEASURED):



LED XP-E
 FWHM Asymmetric
 Efficiency 94 %
 Peak intensity 2.5 cd/lm
 LEDs/each optic 1
 Light colour White
 Required components:

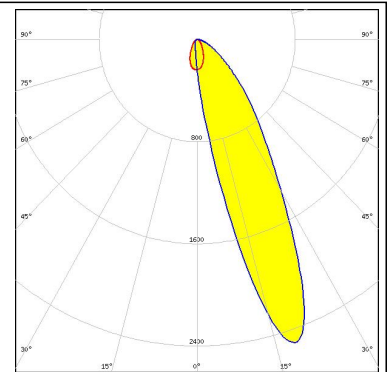
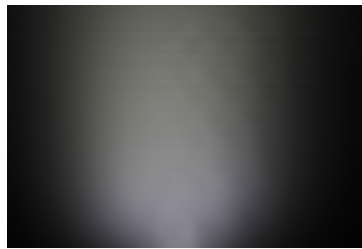

LED XP-G
 FWHM Asymmetric
 Efficiency 93 %
 Peak intensity 2.3 cd/lm
 LEDs/each optic 1
 Light colour White
 Required components:

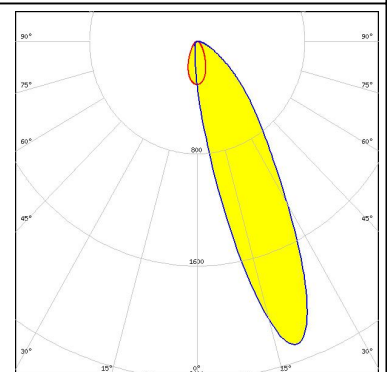
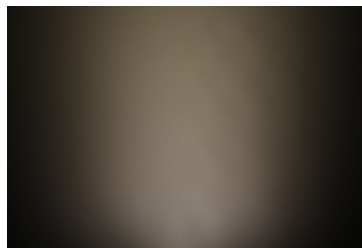

LED LUXEON Rebel
 FWHM Asymmetric
 Efficiency 93 %
 Peak intensity 2.1 cd/lm
 LEDs/each optic 1
 Light colour White
 Required components:

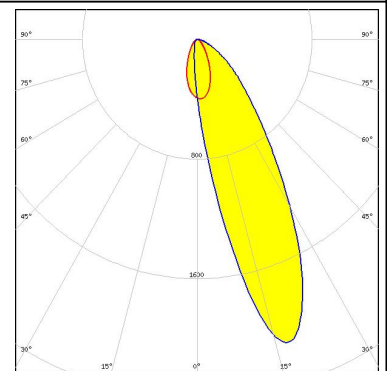
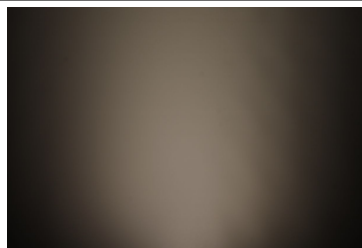

LED LUXEON Rebel ES
 FWHM Asymmetric
 Efficiency 92 %
 Peak intensity 2 cd/lm
 LEDs/each optic 1
 Light colour White
 Required components:

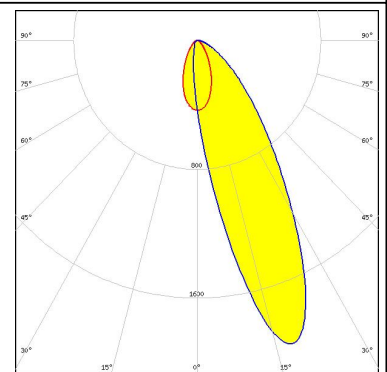
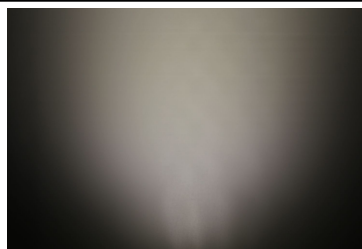

PHOTOMETRIC DATA (MEASURED):



LED NCSxx19B
 FWHM Asymmetric
 Efficiency 92 %
 Peak intensity 2.1 cd/lm
 LEDs/each optic 1
 Light colour White
 Required components:

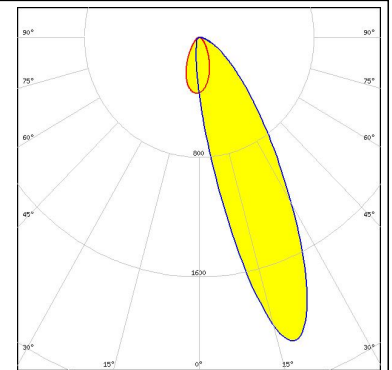
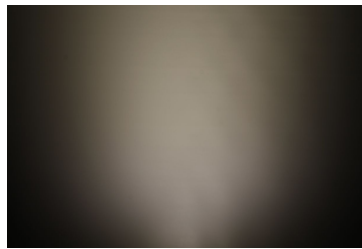

LED NF2x757D
 FWHM Asymmetric
 Efficiency 93 %
 Peak intensity 1.9 cd/lm
 LEDs/each optic 1
 Light colour White
 Required components:

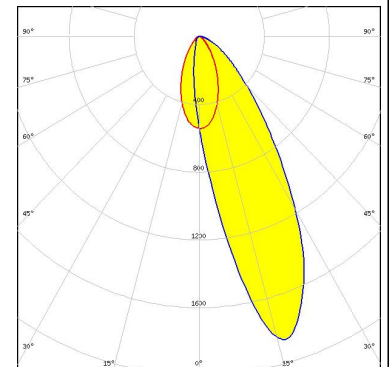

LED NVSxx19B/NVSxx19C
 FWHM Asymmetric
 Efficiency 91 %
 Peak intensity 1.8 cd/lm
 LEDs/each optic 1
 Light colour White
 Required components:

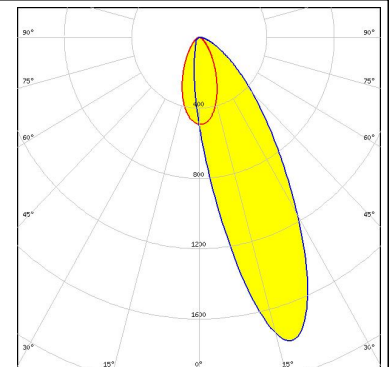
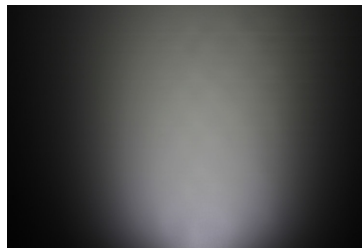

LED Duris S5 (2 chip)
 FWHM Asymmetric
 Efficiency 93 %
 Peak intensity 1.9 cd/lm
 LEDs/each optic 1
 Light colour White
 Required components:

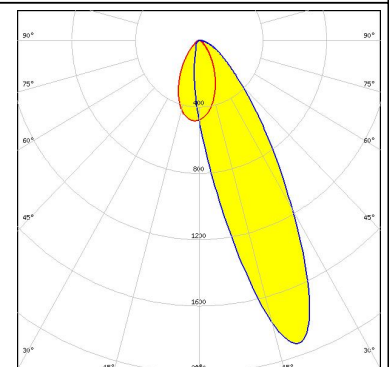
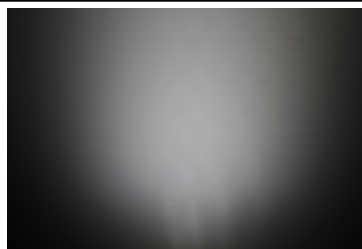

PHOTOMETRIC DATA (MEASURED):

OSRAM
Opto Semiconductors

LED OSLON Square EC
FWHM Asymmetric
Efficiency 93 %
Peak intensity 2 cd/lm
LEDs/each optic 1
Light colour White
Required components:

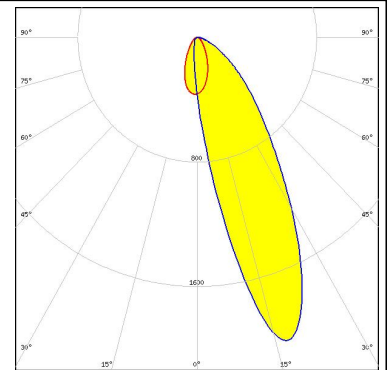
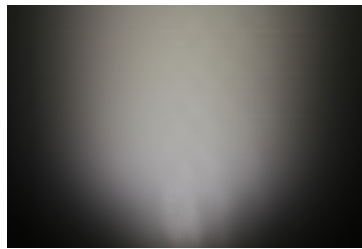

SAMSUNG

LED LH351B
FWHM Asymmetric
Efficiency 93 %
Peak intensity 2.1 cd/lm
LEDs/each optic 1
Light colour White
Required components:

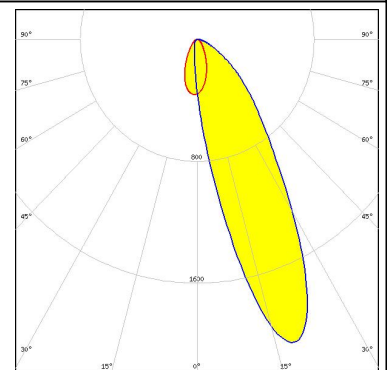
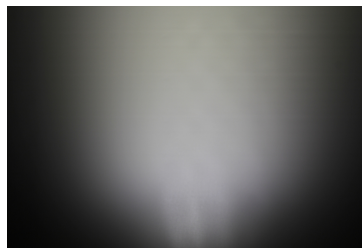

SAMSUNG

LED LH351Z
FWHM Asymmetric
Efficiency 94 %
Peak intensity 2.3 cd/lm
LEDs/each optic 1
Light colour White
Required components:

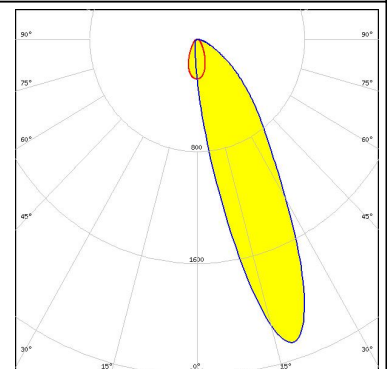
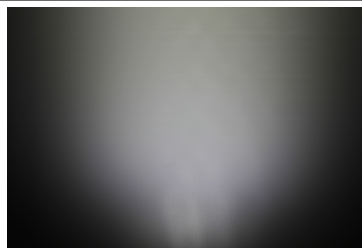

SEOUL SEMICONDUCTOR

LED Z5M1/Z5M2
FWHM Asymmetric
Efficiency 94 %
Peak intensity 2.2 cd/lm
LEDs/each optic 1
Light colour White
Required components:

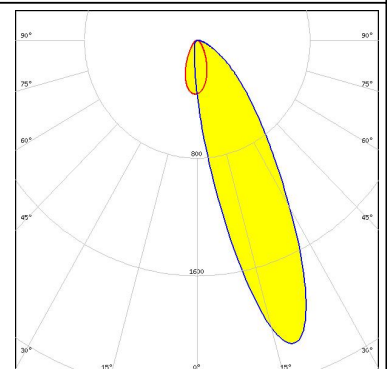
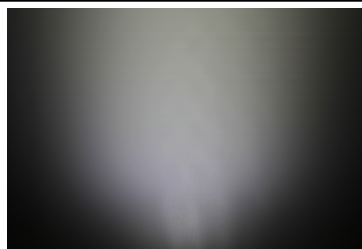

PHOTOMETRIC DATA (SIMULATED):



LED	NF2x757G
FWHM	Asymmetric
Efficiency	93 %
Peak intensity	2 cd/lm
LEDs/each optic	1
Light colour	White
Required components:	

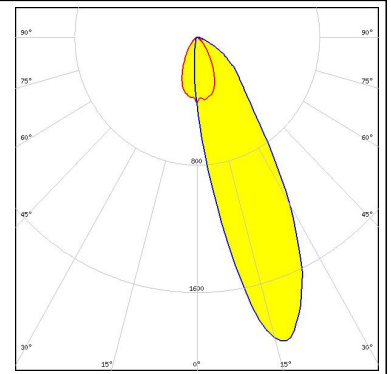

GENERAL INFORMATION:

NOTE: The typical beam angle will be changed by different color, chip size and chip position tolerance. The typical total beam angle is the full angle measured where the luminous intensity is half of the peak value.

MATERIALS:

As part of our continuous research and improvement processes, and to ensure the best possible quality and availability of our products, LEDiL reserves the right to change material grades without notice.

PRODUCT DATA USER AGREEMENT AND DISCLAIMER:

The measured data in the provided downloadable LEDiL Product Datasheets and Mechanical 2D-Drawings is rounded and provided as reference for planning. LEDiL Oy's optical specifications have been verified by conducting performance testing of the products in accordance with the company's quality system. The reported data are averaged results of multiple measurements with typical variation. LEDiL Oy reserves the right to without prior notification make changes and improvements to its products.

LEDiL Oy assumes neither warranty, nor guarantee nor any other liability of any kind for the contents and correctness of the provided data. The provided data has been generated with highest diligence but the provided data may in reality not represent the complete possible variation range of all intrinsic parameters. Therefore, in certain cases a deviation from the provided data could occur.

LEDiL Oy reserves the right to undertake technical changes of its products without further notification which could lead to changes in the provided data. LEDiL Oy assumes no liability of any kind for the possible deviation from any provided data or any other damage resulting from the usage of the provided data.

The user agrees to this disclaimer and user agreement with the download or usage of the provided files.

LEDiL Oy

Joensuunkatu 13
FI-24240 SALO
Finland

LEDiL Inc.

228 West Page Street
Suite D
Sycamore IL 60178
USA

Local sales and technical support

[www.ledil.com/
where_to_buy](http://www.ledil.com/where_to_buy)

Shipping locations

Salo, Finland
Hong Kong, China

Distribution Partners

[www.ledil.com/
where_to_buy](http://www.ledil.com/where_to_buy)

Данный компонент на территории Российской Федерации

Вы можете приобрести в компании MosChip.

Для оперативного оформления запроса Вам необходимо перейти по данной ссылке:

<http://moschip.ru/get-element>

Вы можете разместить у нас заказ для любого Вашего проекта, будь то серийное производство или разработка единичного прибора.

В нашем ассортименте представлены ведущие мировые производители активных и пассивных электронных компонентов.

Нашей специализацией является поставка электронной компонентной базы двойного назначения, продукции таких производителей как XILINX, Intel (ex.ALTERA), Vicor, Microchip, Texas Instruments, Analog Devices, Mini-Circuits, Amphenol, Glenair.

Сотрудничество с глобальными дистрибьюторами электронных компонентов, предоставляет возможность заказывать и получать с международных складов практически любой перечень компонентов в оптимальные для Вас сроки.

На всех этапах разработки и производства наши партнеры могут получить квалифицированную поддержку опытных инженеров.

Система менеджмента качества компании отвечает требованиям в соответствии с ГОСТ Р ИСО 9001, ГОСТ РВ 0015-002 и ЭС РД 009

Офис по работе с юридическими лицами:

105318, г.Москва, ул.Щербаковская д.3, офис 1107, 1118, ДЦ «Щербаковский»

Телефон: +7 495 668-12-70 (многоканальный)

Факс: +7 495 668-12-70 (доб.304)

E-mail: info@moschip.ru

Skype отдела продаж:

moschip.ru

moschip.ru_4

moschip.ru_6

moschip.ru_9