

### PHASE CONTROL THYRISTORS

### Hockey Puk Version

#### Features

- Center amplifying gate
- Metal case with ceramic insulator
- International standard case TO-200AB (E-PUK)

#### Typical Applications

- DC motor controls
- Controlled DC power supplies
- AC controllers

#### Major Ratings and Characteristics

Parameters	ST330C..C	Units	
$I_{T(AV)}$	720	A	
@ $T_{hs}$	55	°C	
$I_{T(RMS)}$	1420	A	
@ $T_{hs}$	25	°C	
$I_{TSM}$	@ 50Hz	9000	A
	@ 60Hz	9420	A
$I^2t$	@ 50Hz	405	KA <sup>2</sup> s
	@ 60Hz	370	KA <sup>2</sup> s
$V_{DRM}/V_{RRM}$	400 to 1600	V	
$t_q$ typical	100	μs	
$T_J$	- 40 to 125	°C	

720A

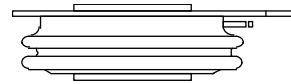

case style TO-200AB (E-PUK)

## ST330C..C Series

Bulletin I25155 rev. C 04/00

International  
IRF Rectifier

### ELECTRICAL SPECIFICATIONS

#### Voltage Ratings

Type number	Voltage Code	$V_{DRM}/V_{RRM}$ , max. repetitive peak and off-state voltage V	$V_{RSM}$ , maximum non-repetitive peak voltage V	$I_{DRM}/I_{RRM}$ max. @ $T_J = T_J$ max mA
ST330C..C	04	400	500	50
	08	800	900	
	12	1200	1300	
	14	1400	1500	
	16	1600	1700	

#### On-state Conduction

Parameter	ST330C..C	Units	Conditions	
$I_{T(AV)}$ Max. average on-state current @ Heatsink temperature	720 (350)	A	180° conduction, half sine wave	
	55 (75)	°C	double side (single side) cooled	
$I_{T(RMS)}$ Max. RMS on-state current	1420	A	DC @ 25°C heatsink temperature double side cooled	
$I_{TSM}$ Max. peak, one-cycle non-repetitive surge current	9000		t = 10ms	No voltage reappplied
	9420		t = 8.3ms	reappplied
	7570		t = 10ms	100% $V_{RRM}$
	7920		t = 8.3ms	reappplied
$I^2t$ Maximum $I^2t$ for fusing	405	KA <sup>2</sup> s	t = 10ms	No voltage reappplied
	370		t = 8.3ms	reappplied
	287		t = 10ms	100% $V_{RRM}$
	262		t = 8.3ms	reappplied
$I^2\sqrt{t}$ Maximum $I^2\sqrt{t}$ for fusing	4050	KA <sup>2</sup> √s	t = 0.1 to 10ms, no voltage reappplied	
$V_{T(TO)1}$ Low level value of threshold voltage	0.91	V	$(16.7\% \times \pi \times I_{T(AV)} < I < \pi \times I_{T(AV)})$ , $T_J = T_J$ max.	
$V_{T(TO)2}$ High level value of threshold voltage	0.92		$(I > \pi \times I_{T(AV)})$ , $T_J = T_J$ max.	
$r_{t1}$ Low level value of on-state slope resistance	0.58	mΩ	$(16.7\% \times \pi \times I_{T(AV)} < I < \pi \times I_{T(AV)})$ , $T_J = T_J$ max.	
$r_{t2}$ High level value of on-state slope resistance	0.57		$(I > \pi \times I_{T(AV)})$ , $T_J = T_J$ max.	
$V_{TM}$ Max. on-state voltage	1.96	V	$I_{pk} = 1810A$ , $T_J = T_J$ max, $t_p = 10ms$ sine pulse	
$I_H$ Maximum holding current	600	mA	$T_J = 25^\circ C$ , anode supply 12V resistive load	
$I_L$ Typical latching current	1000			

#### Switching

Parameter	ST330C..C	Units	Conditions
$di/dt$ Max. non-repetitive rate of rise of turned-on current	1000	A/μs	Gate drive 20V, 20Ω, $t_r \leq 1\mu s$ $T_J = T_J$ max, anode voltage $\leq 80\% V_{DRM}$
$t_d$ Typical delay time	1.0	μs	Gate current 1A, $di_g/dt = 1A/\mu s$ $V_d = 0.67\% V_{DRM}$ , $T_J = 25^\circ C$
$t_q$ Typical turn-off time	100		$I_{TM} = 550A$ , $T_J = T_J$ max, $di/dt = 40A/\mu s$ , $V_R = 50V$ $dv/dt = 20V/\mu s$ , Gate 0V 100Ω, $t_p = 500\mu s$

**Blocking**

Parameter	ST330C..C	Units	Conditions
dv/dt Maximum critical rate of rise of off-state voltage	500	V/ $\mu$ s	$T_J = T_J$ max. linear to 80% rated $V_{DRM}$
$I_{RRM}$ $I_{DRM}$ Max. peak reverse and off-state leakage current	50	mA	$T_J = T_J$ max, rated $V_{DRM}/V_{RRM}$ applied

**Triggering**

Parameter	ST330C..C	Units	Conditions
$P_{GM}$ Maximum peak gate power	10.0	W	$T_J = T_J$ max, $t_p \leq 5$ ms
$P_{G(AV)}$ Maximum average gate power	2.0		$T_J = T_J$ max, $f = 50$ Hz, $d\% = 50$
$I_{GM}$ Max. peak positive gate current	3.0	A	$T_J = T_J$ max, $t_p \leq 5$ ms
$+V_{GM}$ Maximum peak positive gate voltage	20	V	$T_J = T_J$ max, $t_p \leq 5$ ms
$-V_{GM}$ Maximum peak negative gate voltage	5.0		
$I_{GT}$ DC gate current required to trigger	TYP.	MAX.	$T_J = -40^\circ\text{C}$ $T_J = 25^\circ\text{C}$ $T_J = 125^\circ\text{C}$ Max. required gate trigger/ current/ voltage are the lowest value which will trigger all units 12V anode-to-cathode applied
	200	-	
	100	200	
$V_{GT}$ DC gate voltage required to trigger	2.5	-	$T_J = -40^\circ\text{C}$ $T_J = 25^\circ\text{C}$ $T_J = 125^\circ\text{C}$
	1.8	3.0	
	1.1	-	
$I_{GD}$ DC gate current not to trigger	10	mA	$T_J = T_J$ max Max. gate current/voltage not to trigger is the max. value which will not trigger any unit with rated $V_{DRM}$ anode-to-cathode applied
$V_{GD}$ DC gate voltage not to trigger	0.25	V	

**Thermal and Mechanical Specification**

Parameter	ST330C..C	Units	Conditions
$T_J$ Max. operating temperature range	-40 to 125	$^\circ\text{C}$	
$T_{stg}$ Max. storage temperature range	-40 to 150		
$R_{thJ-hs}$ Max. thermal resistance, junction to heatsink	0.09	K/W	DC operation single side cooled
	0.04		DC operation double side cooled
$R_{thC-hs}$ Max. thermal resistance, case to heatsink	0.02	K/W	DC operation single side cooled
	0.01		DC operation double side cooled
F Mounting force, $\pm 10\%$	9800	N	
	(1000)	(Kg)	
wt Approximate weight	83	g	
Case style	TO - 200AB (E-PUK)		See Outline Table

## ST330C..C Series

Bulletin I25155 rev. C 04/00

International  
**IR** Rectifier

### $\Delta R_{thJ-hs}$ Conduction

(The following table shows the increment of thermal resistance  $R_{thJ-hs}$  when devices operate at different conduction angles than DC)

Conduction angle	Sinusoidal conduction		Rectangular conduction		Units	Conditions
	Single Side	Double Side	Single Side	Double Side		
180°	0.012	0.011	0.008	0.007	K/W	$T_J = T_{J \text{ max.}}$
120°	0.014	0.012	0.014	0.013		
90°	0.017	0.015	0.019	0.017		
60°	0.025	0.022	0.026	0.023		
30°	0.043	0.036	0.043	0.037		

### Ordering Information Table

Device Code							
ST	33	0	C	16	C	1	
①	②	③	④	⑤	⑥	⑦	⑧
<b>1</b>	- Thyristor	<b>2</b>	- Essential part number	<b>3</b>	- 0 = Converter grade	<b>4</b>	- C = Ceramic Puk
<b>5</b>	- Voltage code: Code x 100 = $V_{RRM}$ (See Voltage Rating Table)	<b>6</b>	- C = Puk Case TO-200AB (E-PUK)	<b>7</b>	- 0 = Eyelet terminals (Gate and Auxiliary Cathode Unsoldered Leads) 1 = Fast-on terminals (Gate and Auxiliary Cathode Unsoldered Leads) 2 = Eyelet terminals (Gate and Auxiliary Cathode Soldered Leads) 3 = Fast-on terminals (Gate and Auxiliary Cathode Soldered Leads)	<b>8</b>	- Critical dv/dt: None = 500V/ $\mu$ sec (Standard selection) L = 1000V/ $\mu$ sec (Special selection)

Outline Table

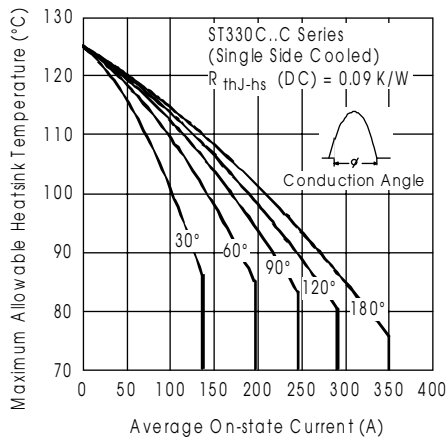
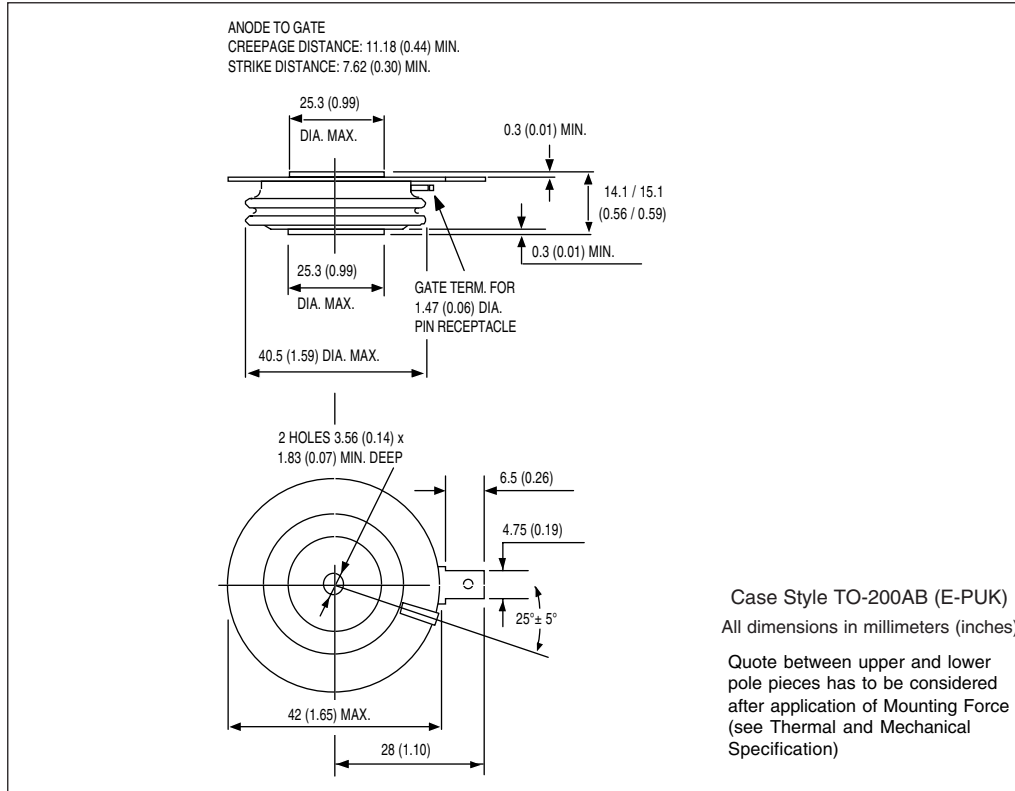

Fig. 1 - Current Ratings Characteristics

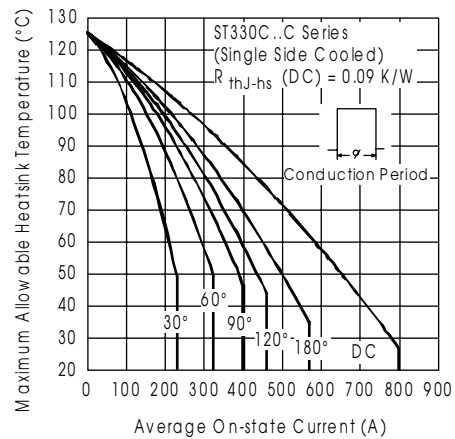

Fig. 2 - Current Ratings Characteristics

# ST330C..C Series

Bulletin I25155 rev. C 04/00

International  
**IRF** Rectifier

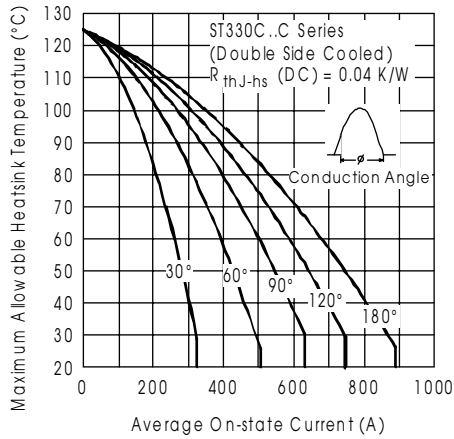

Fig. 3 - Current Ratings Characteristics

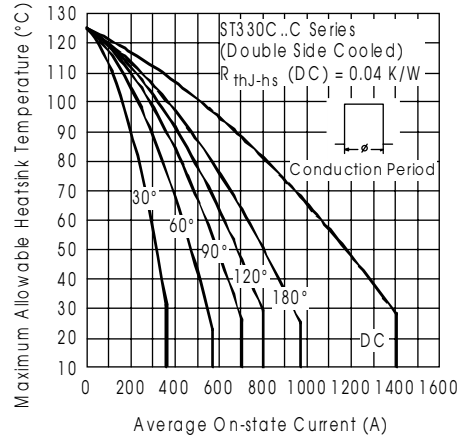

Fig. 4 - Current Ratings Characteristics

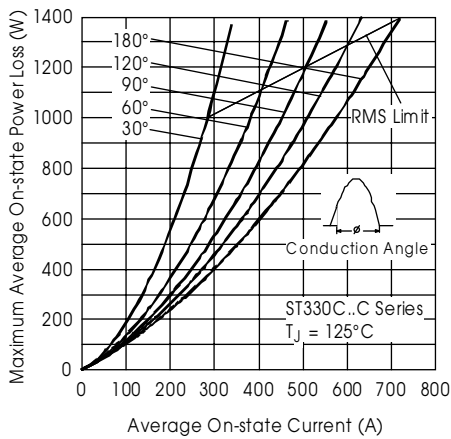

Fig. 5 - On-state Power Loss Characteristics

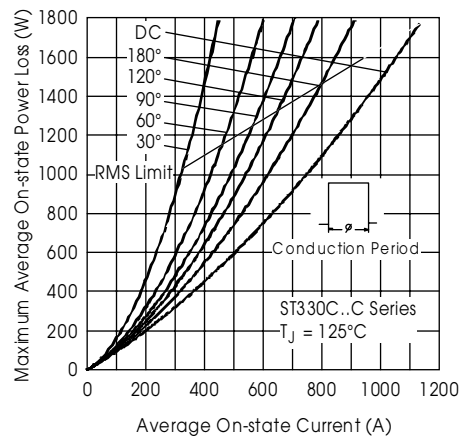

Fig. 6 - On-state Power Loss Characteristics

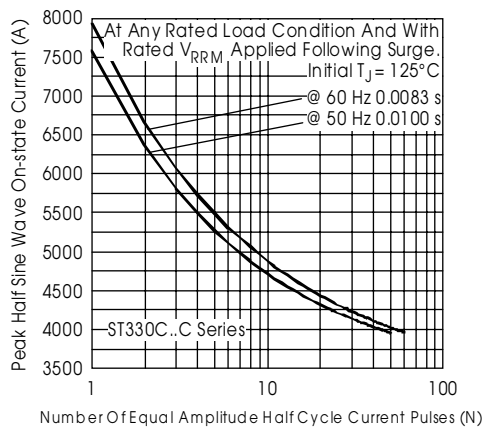

Fig. 7 - Maximum Non-Repetitive Surge Current Single and Double Side Cooled

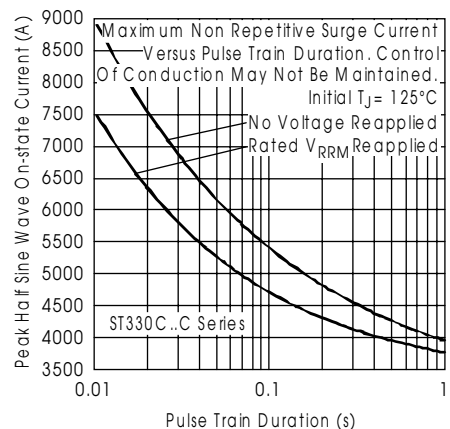

Fig. 8 - Maximum Non-Repetitive Surge Current Single and Double Side Cooled

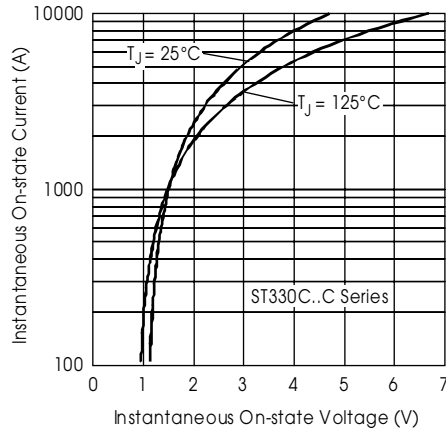

Fig. 9 - On-state Voltage Drop Characteristics

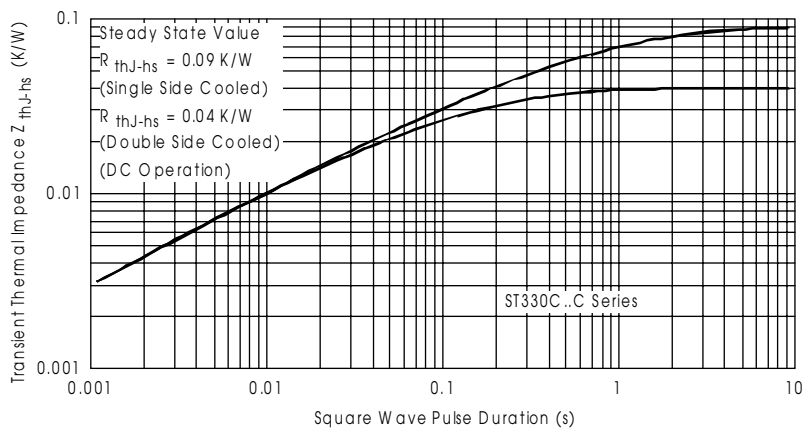

Fig. 10 - Thermal Impedance  $Z_{thJ-hs}$  Characteristics

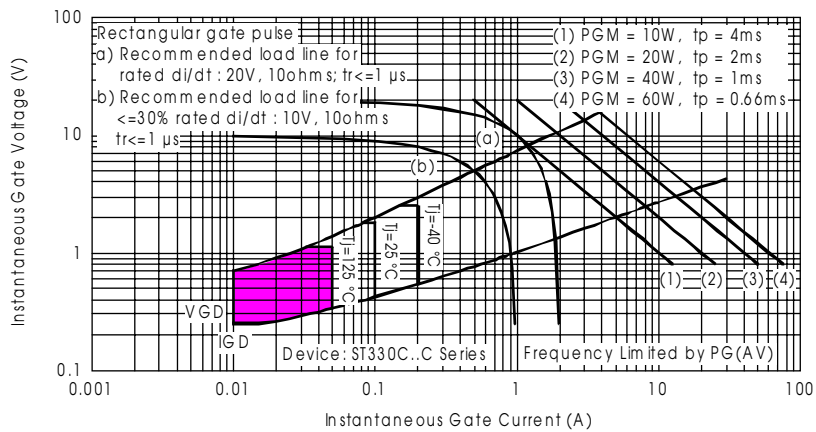

Fig. 11 - Gate Characteristics

## Данный компонент на территории Российской Федерации

### Вы можете приобрести в компании MosChip.

Для оперативного оформления запроса Вам необходимо перейти по данной ссылке:

<http://moschip.ru/get-element>

Вы можете разместить у нас заказ для любого Вашего проекта, будь то серийное производство или разработка единичного прибора.

В нашем ассортименте представлены ведущие мировые производители активных и пассивных электронных компонентов.

Нашей специализацией является поставка электронной компонентной базы двойного назначения, продукции таких производителей как XILINX, Intel (ex.ALTERA), Vicor, Microchip, Texas Instruments, Analog Devices, Mini-Circuits, Amphenol, Glenair.

Сотрудничество с глобальными дистрибьюторами электронных компонентов, предоставляет возможность заказывать и получать с международных складов практически любой перечень компонентов в оптимальные для Вас сроки.

На всех этапах разработки и производства наши партнеры могут получить квалифицированную поддержку опытных инженеров.

Система менеджмента качества компании отвечает требованиям в соответствии с ГОСТ Р ИСО 9001, ГОСТ РВ 0015-002 и ЭС РД 009

### Офис по работе с юридическими лицами:

105318, г.Москва, ул.Щербаковская д.3, офис 1107, 1118, ДЦ «Щербаковский»

Телефон: +7 495 668-12-70 (многоканальный)

Факс: +7 495 668-12-70 (доб.304)

E-mail: [info@moschip.ru](mailto:info@moschip.ru)

Skype отдела продаж:

moschip.ru

moschip.ru\_4

moschip.ru\_6

moschip.ru\_9