

PHASE CONTROL THYRISTORS

Hockey Puk Version

Features

- Center amplifying gate
- Metal case with ceramic insulator
- International standard case TO-200AB (E-PUK)

Typical Applications

- DC motor controls
- Controlled DC power supplies
- AC controllers

Major Ratings and Characteristics

Parameters	ST330C..C	Units	
$I_{T(AV)}$	720	A	
@ T_{hs}	55	°C	
$I_{T(RMS)}$	1420	A	
@ T_{hs}	25	°C	
I_{TSM}	@ 50Hz	9000	A
	@ 60Hz	9420	A
I^2t	@ 50Hz	405	KA ² s
	@ 60Hz	370	KA ² s
V_{DRM}/V_{RRM}	400 to 1600	V	
t_q typical	100	μs	
T_J	- 40 to 125	°C	

720A

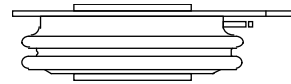

case style TO-200AB (E-PUK)

ST330C..C Series

Bulletin I25155 rev. C 04/00

International
IRF Rectifier

ELECTRICAL SPECIFICATIONS

Voltage Ratings

Type number	Voltage Code	V_{DRM}/V_{RRM} , max. repetitive peak and off-state voltage V	V_{RSM} , maximum non-repetitive peak voltage V	I_{DRM}/I_{RRM} max. @ $T_J = T_J$ max mA
ST330C..C	04	400	500	50
	08	800	900	
	12	1200	1300	
	14	1400	1500	
	16	1600	1700	

On-state Conduction

Parameter	ST330C..C	Units	Conditions	
$I_{T(AV)}$ Max. average on-state current @ Heatsink temperature	720 (350)	A	180° conduction, half sine wave	
	55 (75)	°C	double side (single side) cooled	
$I_{T(RMS)}$ Max. RMS on-state current	1420	A	DC @ 25°C heatsink temperature double side cooled	
I_{TSM} Max. peak, one-cycle non-repetitive surge current	9000		t = 10ms	No voltage reappplied
	9420		t = 8.3ms	100% V_{RRM}
	7570		t = 10ms	reappplied
	7920		t = 8.3ms	reappplied
I^2t Maximum I^2t for fusing	405	KA ² s	t = 10ms	No voltage reappplied
	370		t = 8.3ms	100% V_{RRM}
	287		t = 10ms	reappplied
	262		t = 8.3ms	reappplied
$I^2\sqrt{t}$ Maximum $I^2\sqrt{t}$ for fusing	4050	KA ² √s	t = 0.1 to 10ms, no voltage reappplied	
$V_{T(TO)1}$ Low level value of threshold voltage	0.91	V	$(16.7\% \times \pi \times I_{T(AV)} < I < \pi \times I_{T(AV)})$, $T_J = T_J$ max.	
$V_{T(TO)2}$ High level value of threshold voltage	0.92		$(I > \pi \times I_{T(AV)})$, $T_J = T_J$ max.	
r_{t1} Low level value of on-state slope resistance	0.58	mΩ	$(16.7\% \times \pi \times I_{T(AV)} < I < \pi \times I_{T(AV)})$, $T_J = T_J$ max.	
r_{t2} High level value of on-state slope resistance	0.57		$(I > \pi \times I_{T(AV)})$, $T_J = T_J$ max.	
V_{TM} Max. on-state voltage	1.96	V	$I_{pk} = 1810A$, $T_J = T_J$ max, $t_p = 10ms$ sine pulse	
I_H Maximum holding current	600	mA	$T_J = 25^\circ C$, anode supply 12V resistive load	
I_L Typical latching current	1000			

Switching

Parameter	ST330C..C	Units	Conditions
di/dt Max. non-repetitive rate of rise of turned-on current	1000	A/μs	Gate drive 20V, 20Ω, $t_r \leq 1\mu s$ $T_J = T_J$ max, anode voltage $\leq 80\% V_{DRM}$
t_d Typical delay time	1.0	μs	Gate current 1A, $di_g/dt = 1A/\mu s$ $V_d = 0.67\% V_{DRM}$, $T_J = 25^\circ C$
t_q Typical turn-off time	100		$I_{TM} = 550A$, $T_J = T_J$ max, $di/dt = 40A/\mu s$, $V_R = 50V$ $dv/dt = 20V/\mu s$, Gate 0V 100Ω, $t_p = 500\mu s$

Blocking

Parameter	ST330C..C	Units	Conditions
dv/dt Maximum critical rate of rise of off-state voltage	500	V/μs	T _J = T _J max. linear to 80% rated V _{DRM}
I _{RRM} I _{DRM} Max. peak reverse and off-state leakage current	50	mA	T _J = T _J max, rated V _{DRM} /V _{RRM} applied

Triggering

Parameter	ST330C..C	Units	Conditions
P _{GM} Maximum peak gate power	10.0	W	T _J = T _J max, t _p ≤ 5ms
P _{G(AV)} Maximum average gate power	2.0		T _J = T _J max, f = 50Hz, d% = 50
I _{GM} Max. peak positive gate current	3.0	A	T _J = T _J max, t _p ≤ 5ms
+V _{GM} Maximum peak positive gate voltage	20	V	T _J = T _J max, t _p ≤ 5ms
-V _{GM} Maximum peak negative gate voltage	5.0		
I _{GT} DC gate current required to trigger	TYP.	MAX.	T _J = - 40°C T _J = 25°C T _J = 125°C Max. required gate trigger/ current/ voltage are the lowest value which will trigger all units 12V anode-to-cathode applied
	200	-	
	100	200	
V _{GT} DC gate voltage required to trigger	2.5	-	T _J = - 40°C T _J = 25°C T _J = 125°C
	1.8	3.0	
	1.1	-	
I _{GD} DC gate current not to trigger	10	mA	T _J = T _J max Max. gate current/voltage not to trigger is the max. value which will not trigger any unit with rated V _{DRM} anode-to-cathode applied
V _{GD} DC gate voltage not to trigger	0.25	V	

Thermal and Mechanical Specification

Parameter	ST330C..C	Units	Conditions
T _J Max. operating temperature range	-40 to 125	°C	
T _{stg} Max. storage temperature range	-40 to 150		
R _{thJ-hs} Max. thermal resistance, junction to heatsink	0.09 0.04	K/W	DC operation single side cooled DC operation double side cooled
R _{thC-hs} Max. thermal resistance, case to heatsink	0.02 0.01	K/W	DC operation single side cooled DC operation double side cooled
F Mounting force, ± 10%	9800 (1000)	N (Kg)	
wt Approximate weight	83	g	
Case style	TO - 200AB (E-PUK)		See Outline Table

ST330C..C Series

Bulletin I25155 rev. C 04/00

International
IR Rectifier

ΔR_{thJ-hs} Conduction

(The following table shows the increment of thermal resistance R_{thJ-hs} when devices operate at different conduction angles than DC)

Conduction angle	Sinusoidal conduction		Rectangular conduction		Units	Conditions
	Single Side	Double Side	Single Side	Double Side		
180°	0.012	0.011	0.008	0.007	K/W	$T_J = T_{J \text{ max.}}$
120°	0.014	0.012	0.014	0.013		
90°	0.017	0.015	0.019	0.017		
60°	0.025	0.022	0.026	0.023		
30°	0.043	0.036	0.043	0.037		

Ordering Information Table

Device Code							
ST	33	0	C	16	C	1	
①	②	③	④	⑤	⑥	⑦	⑧
1	- Thyristor	2	- Essential part number	3	- 0 = Converter grade	4	- C = Ceramic Puk
5	- Voltage code: Code x 100 = V_{RRM} (See Voltage Rating Table)	6	- C = Puk Case TO-200AB (E-PUK)	7	- 0 = Eyelet terminals (Gate and Auxiliary Cathode Unsoldered Leads) 1 = Fast-on terminals (Gate and Auxiliary Cathode Unsoldered Leads) 2 = Eyelet terminals (Gate and Auxiliary Cathode Soldered Leads) 3 = Fast-on terminals (Gate and Auxiliary Cathode Soldered Leads)	8	- Critical dv/dt: None = 500V/ μ sec (Standard selection) L = 1000V/ μ sec (Special selection)

Outline Table

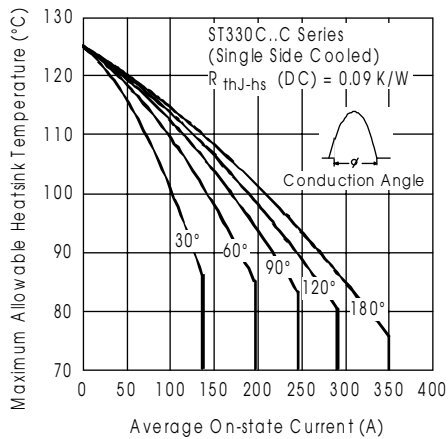
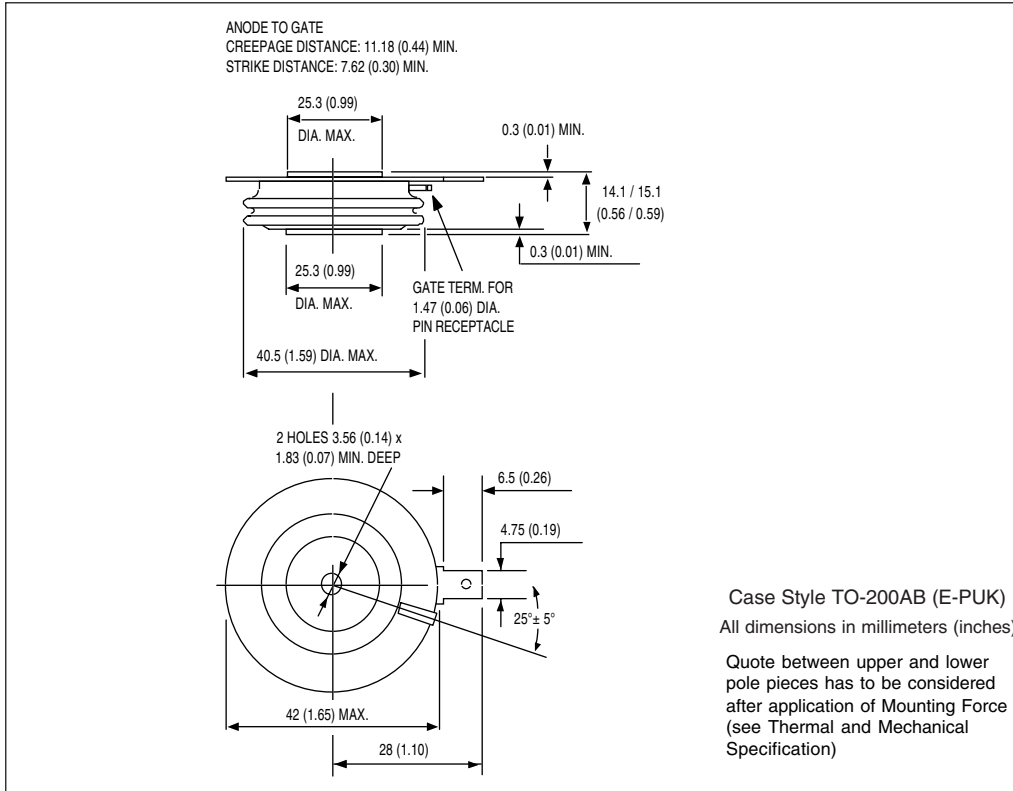

Fig. 1 - Current Ratings Characteristics

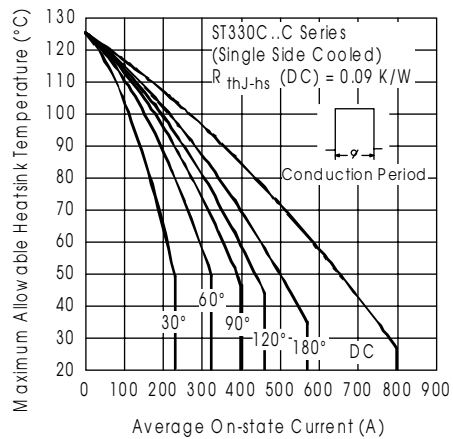

Fig. 2 - Current Ratings Characteristics

ST330C..C Series

Bulletin I25155 rev. C 04/00

International
IRF Rectifier

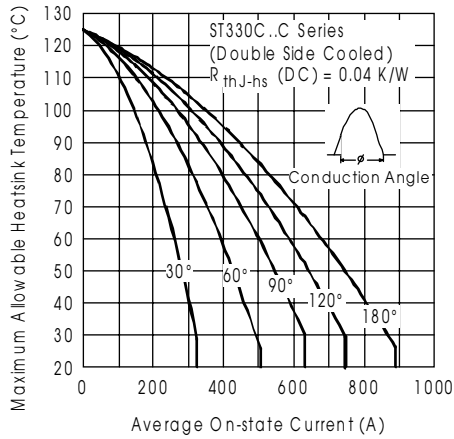

Fig. 3 - Current Ratings Characteristics

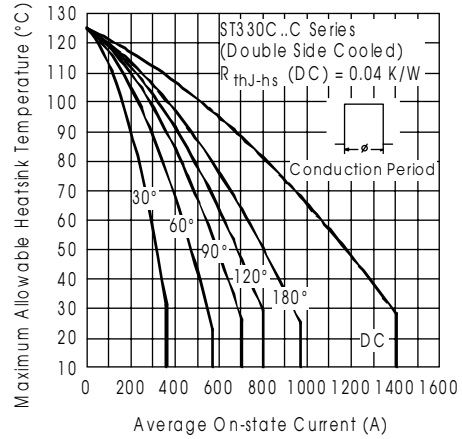

Fig. 4 - Current Ratings Characteristics

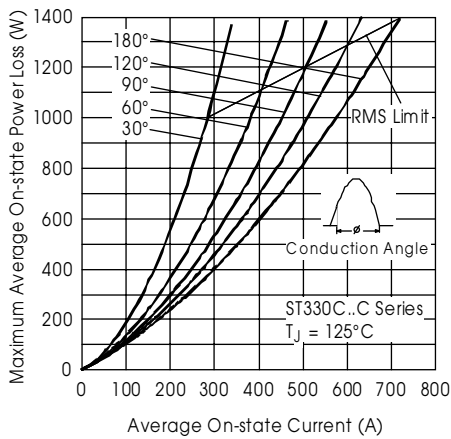

Fig. 5 - On-state Power Loss Characteristics

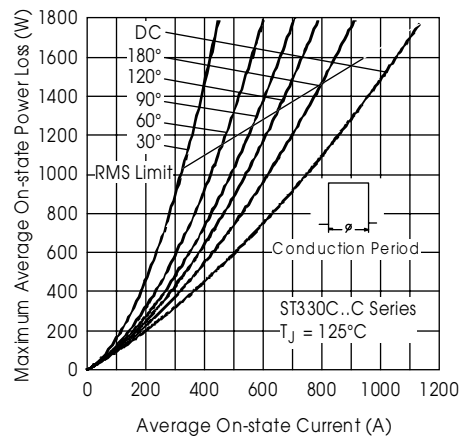

Fig. 6 - On-state Power Loss Characteristics

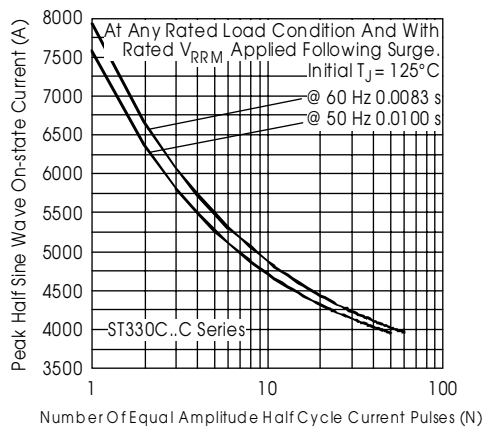

Fig. 7 - Maximum Non-Repetitive Surge Current Single and Double Side Cooled

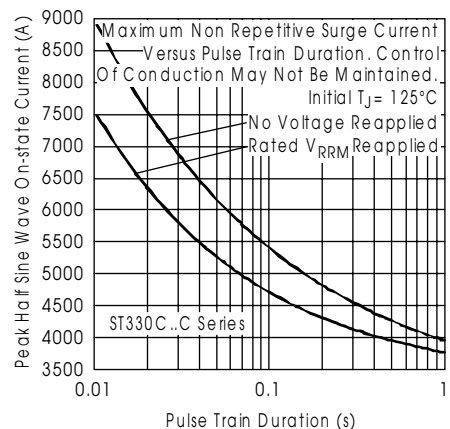

Fig. 8 - Maximum Non-Repetitive Surge Current Single and Double Side Cooled

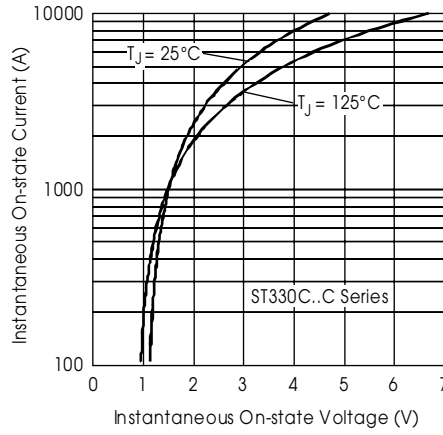

Fig. 9 - On-state Voltage Drop Characteristics

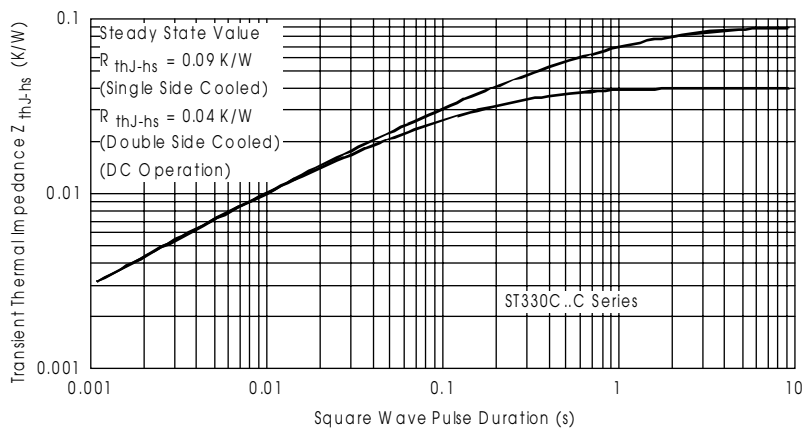

Fig. 10 - Thermal Impedance Z_{thJ-hs} Characteristics

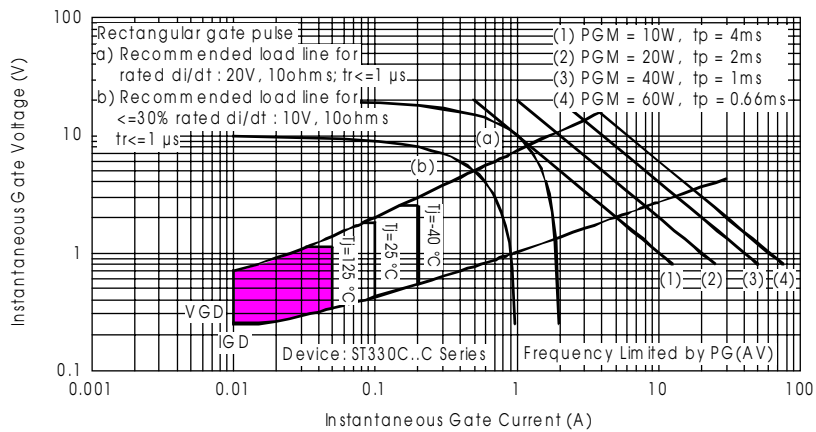

Fig. 11 - Gate Characteristics

Данный компонент на территории Российской Федерации

Вы можете приобрести в компании MosChip.

Для оперативного оформления запроса Вам необходимо перейти по данной ссылке:

<http://moschip.ru/get-element>

Вы можете разместить у нас заказ для любого Вашего проекта, будь то серийное производство или разработка единичного прибора.

В нашем ассортименте представлены ведущие мировые производители активных и пассивных электронных компонентов.

Нашей специализацией является поставка электронной компонентной базы двойного назначения, продукции таких производителей как XILINX, Intel (ex.ALTERA), Vicor, Microchip, Texas Instruments, Analog Devices, Mini-Circuits, Amphenol, Glenair.

Сотрудничество с глобальными дистрибьюторами электронных компонентов, предоставляет возможность заказывать и получать с международных складов практически любой перечень компонентов в оптимальные для Вас сроки.

На всех этапах разработки и производства наши партнеры могут получить квалифицированную поддержку опытных инженеров.

Система менеджмента качества компании отвечает требованиям в соответствии с ГОСТ Р ИСО 9001, ГОСТ РВ 0015-002 и ЭС РД 009

Офис по работе с юридическими лицами:

105318, г.Москва, ул.Щербаковская д.3, офис 1107, 1118, ДЦ «Щербаковский»

Телефон: +7 495 668-12-70 (многоканальный)

Факс: +7 495 668-12-70 (доб.304)

E-mail: info@moschip.ru

Skype отдела продаж:

moschip.ru

moschip.ru_4

moschip.ru_6

moschip.ru_9