

Product Overview

Qorvo’s TGL2217-SM is a packaged high power, wideband GaAs VPIN limiter capable of protecting sensitive receive channel components against high power incident signals. The TGL2217-SM does not require DC bias and achieves a low insertion loss all in a small form factor. These features allow for simple integration with minimal impact to system performance.

The TGL2217-SM operates from 0.1–20.0 GHz with low insertion loss of less than 0.9 dB. Receive protection is rated up to 10 W incident pulsed power with a low flat leakage of less than 18.5 dBm.

The TGL2217-SM is offered in a small 3.5 x 3.5 mm QFN package for simple board level assembly. Fully matched to 50 ohms on both RF ports, it is well suited for both commercial and defense related applications.

Lead-free and RoHS compliant.

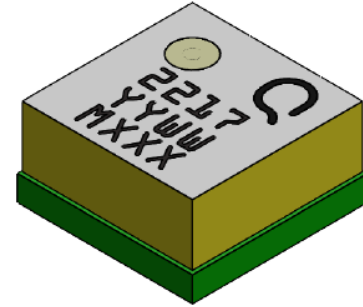

14 Pad 3.5 x 3.5 mm Air Cavity QFN Package

Key Features

- Frequency Range: 0.1 to 20.0 GHz
- Insertion Loss: < 0.9 dB
- Peak Power Handling: 10 W (pulsed)
- Flat Leakage: < 18.5 dBm
- Spike Leakage < 20.5 dBm
- Recovery Time < 40 nS
- Passive (no DC bias required)
- QFN Package Dimensions: 3.50 x 3.50 x 1.715 mm

Performance is typical across frequency. Please reference electrical specification table and data plots for more details.

Functional Block Diagram

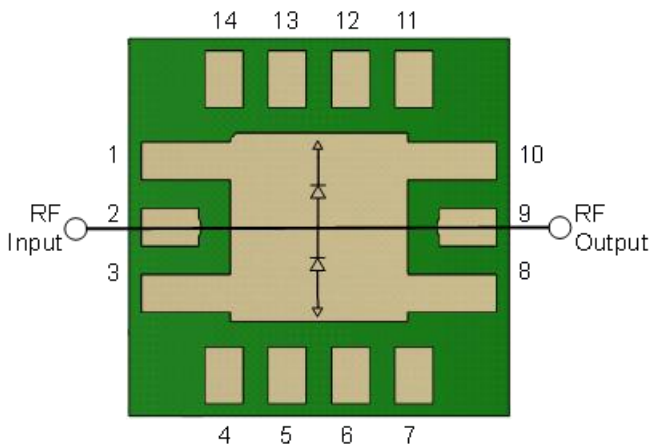

Top View

Applications

- Receive Chain Protection
- Commercial and Military Radar
- Electronic Warfare
- Communications

Ordering Information

Part	Description
TGL2217-SM	0.1–20.0 GHz 10W VPIN Limiter
TGL2217-SMEVB01	0.1–20.0 GHz 10W VPIN Limiter Evaluation Board

Absolute Maximum Ratings

Parameter	Rating
Incident Power, Pulsed, 50 Ω, 85 °C	40 dBm
Incident Power, CW, 50 Ω, 25 °C	36 dBm
Incident Power, CW, 50 Ω, 85 °C	33 dBm
Mounting Temperature (30 s max)	260 °C
Storage Temperature	-40 to 150 °C

Exceeding any one or a combination of the Absolute Maximum Rating conditions may cause permanent damage to the device. Extended application of Absolute Maximum Rating conditions to the device may reduce device reliability.

Recommended Operating Conditions

Parameter	Min	Typ	Max	Units
Operating Temperature Range	-40	+25	+85	°C
Passive – No Bias				

Electrical specifications are measured at specified test conditions. Specifications are not guaranteed over all recommended operating conditions.

Electrical Specifications

Test conditions, unless otherwise noted: 25 °C

Parameter	Conditions ⁽¹⁾	Min	Typ	Max	Units
Operational Frequency Range		0.1		20.0	GHz
Insertion Loss	0.5 GHz		0.08	0.3	dB
	5 GHz		0.27	0.5	
	10 GHz		0.45	0.8	
	15 GHz		0.64	1.1	
	20 GHz		0.83	1.2	
Input Return Loss	0.5 GHz		39		dB
	5 GHz		26		
	10 GHz		24		
	15GHz		19		
	20 GHz		17		
Output Return Loss	0.5 GHz		40		dB
	5 GHz		26		
	10 GHz		27		
	15 GHz		18		
	20 GHz		17		
Flat Leakage Power at P _{IN} > 30 dBm, (CW)	2 GHz		16.7		dBm
	10 GHz		17.7		
	18 GHz		16.9		
Pulse Recovery Time			< 40		nS
Spike Leakage			20.5		dBm
Insertion Loss Temperature Coefficient			0.002		dB/ °C

Thermal and Reliability Information

Parameter	Test Conditions	Value	Units
Incident Power ⁽¹⁾ (RF Operational Life Test)	Frequency = 10 GHz, RF Pulsed, PW=100 μs, DC=10%, 50 Ω, 25°C	10	W

Notes:

1. Test terminated after 168 hours. Insertion Loss remained ≤ 1 dB for device under test.

Performance Plots – Small Signal

Test conditions unless otherwise noted: Temp.=+25 °C

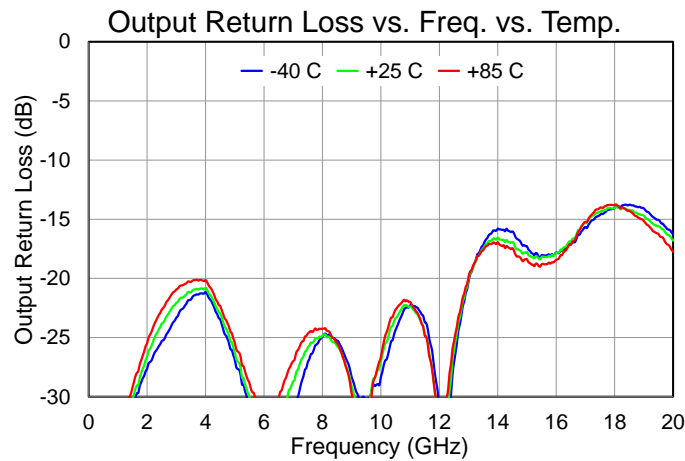
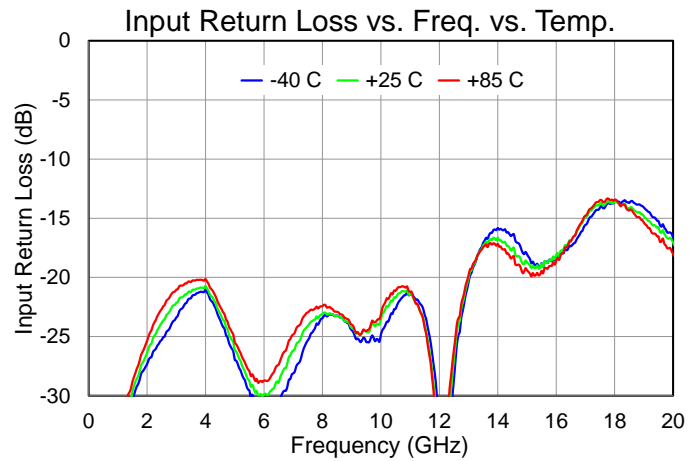
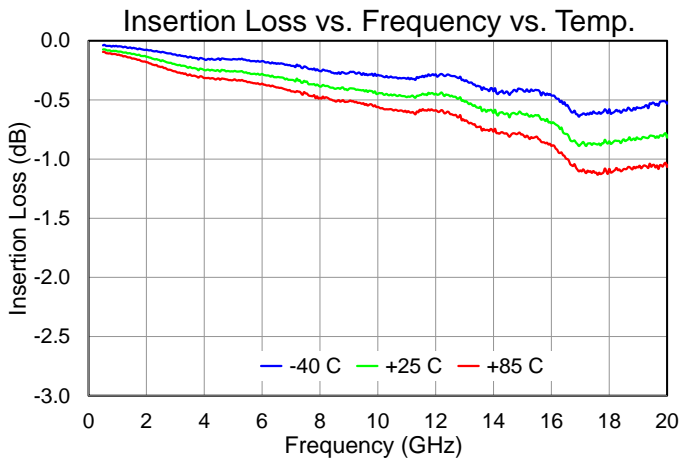

Performance Plots – Large Signal

Test conditions unless otherwise noted: Temp.=+25 °C

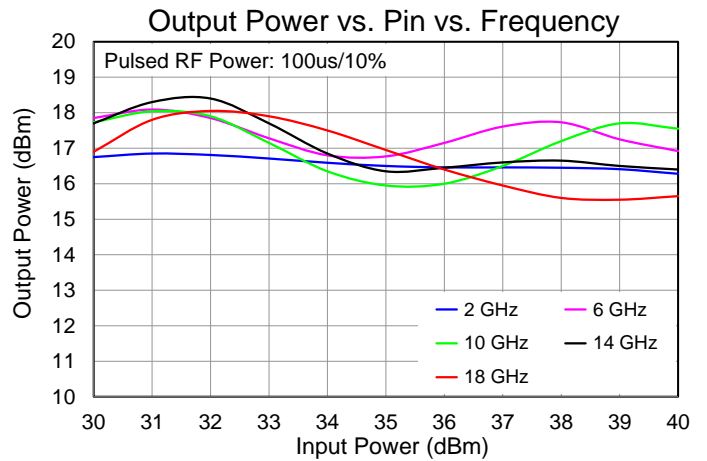
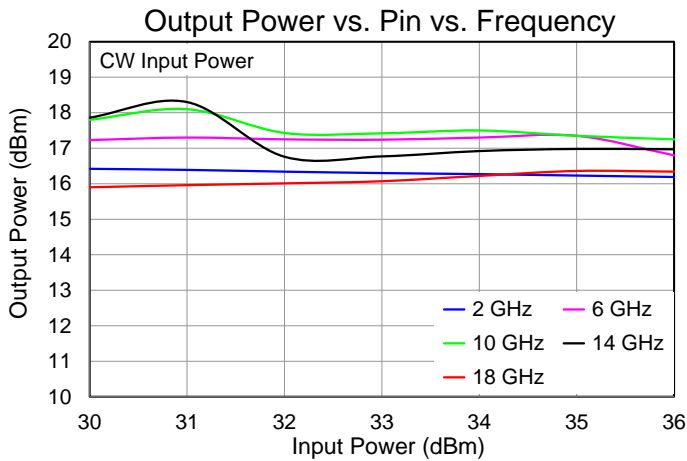
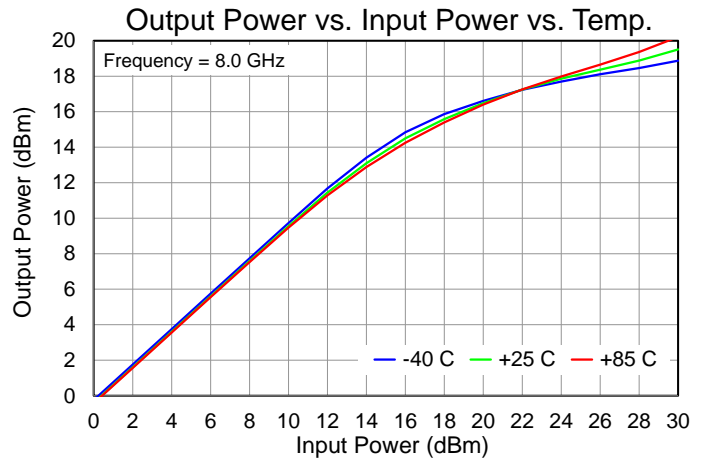
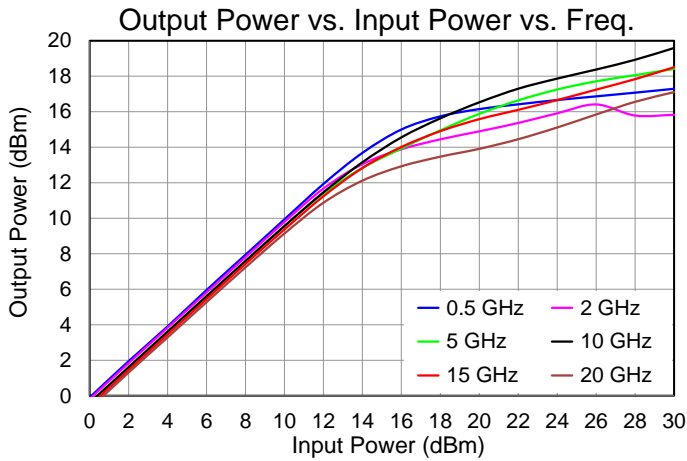

Application Circuit and Evaluation Board (EVB)

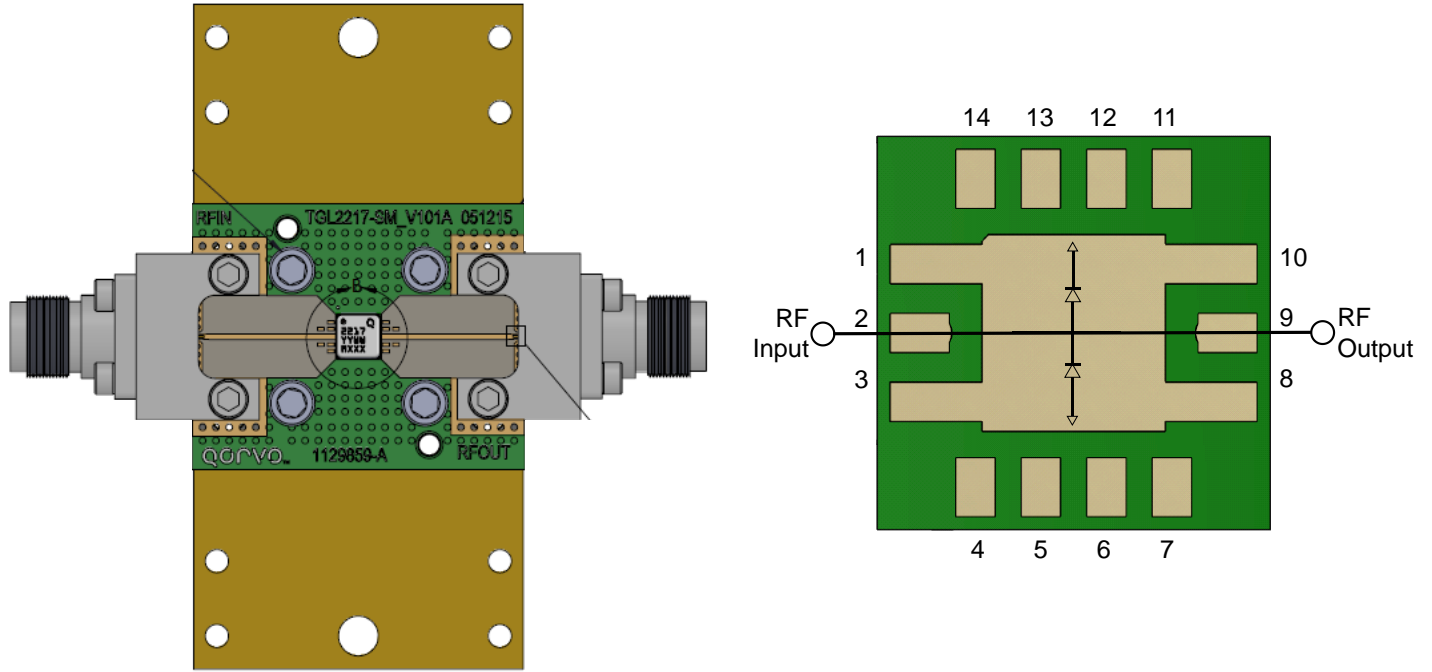

Notes:

1. See Evaluation Board PCB Information for material and stack up.

Bill of Material – EVB

Ref. Des.	Value	Description	Manuf.	Part Number
n/a	n/a	Printed Circuit Board	Qorvo	
U1	n/a	0.1 – 20 GHz 50 W VPIN Limiter	Qorvo	TGL2217-SM
J1, J2	n/a	2.92 mm End Launch Connector	Southwest Microwave	1092-01A-5

Pad Configuration and Description

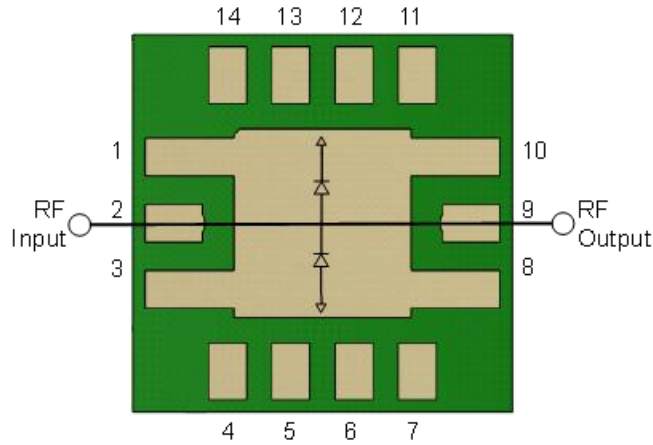

Top View

Pad No.	Label	Description
1, 3, 8, 10	GND	On PCB, multiple copper-filled vias should be employed under the center pad to minimize inductance and thermal resistance
2	RF Input	RF Input, matched to 50 Ohms, not DC blocked
4–7, 11–14	NC	No connection; connecting to ground may improve performance
9	RF Output	RF Output, matched to 50 Ohms, not DC blocked

NOTE: The RF Input and RF Output ports are not interchangeable.

Evaluation Board PCB Information and Mounting Detail

EVB PC Board Layout

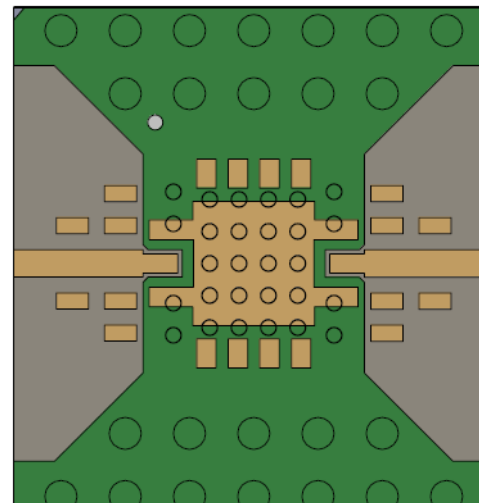
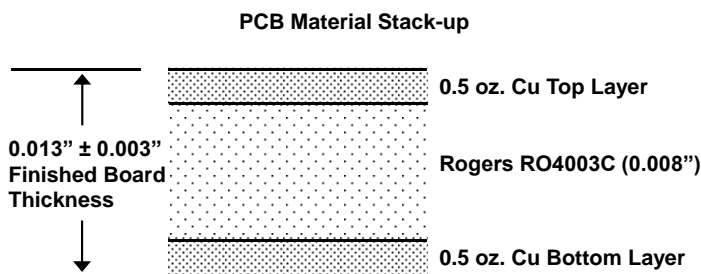

Package Marking and Dimensions

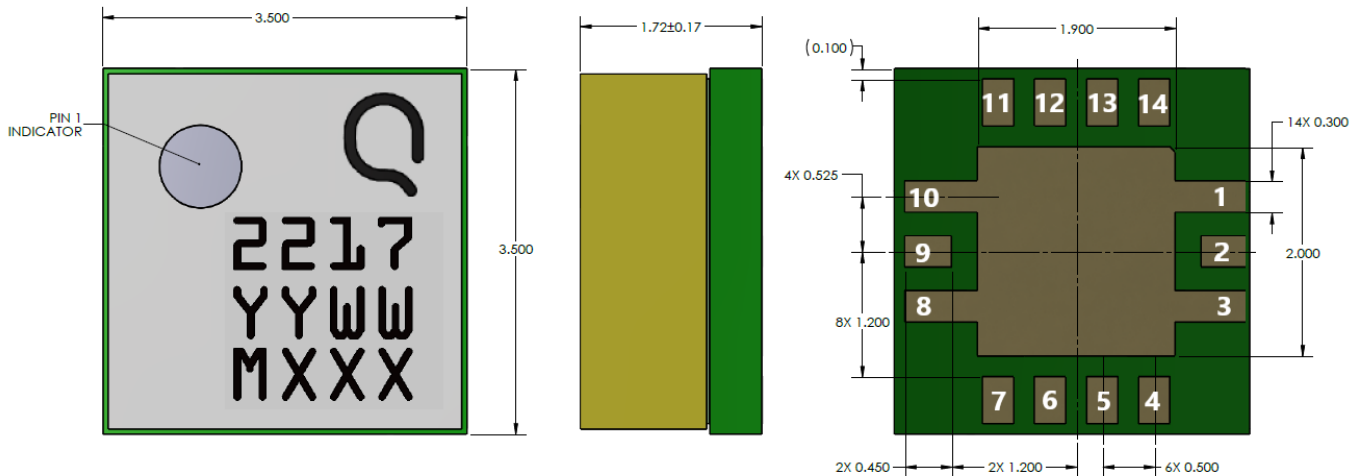

Notes:

1. All dimensions are in millimeters. Angles are in degrees.
Tolerances: XX = ± .25
XXX = ± .100
2. Package Base: Laminate
3. Package Lid: FR4
4. All Metalized Features Are Gold Plated.
5. The Part Is Epoxy Sealed
6. Part Marking:
2217: Part Number
YY: Part assembly Year
WW: Part Assembly Week
MXXX: Batch ID

Assembly Notes

- Compatible with lead-free soldering process with 260°C peak reflow temperature.
- This package is non-hermetic, and therefore cannot be subjected to aqueous washing. The use of no-clean solder to avoid washing after soldering is recommended
- Solder rework not recommended.
- Contact plating: Ni-Au

Recommended Soldering Profile

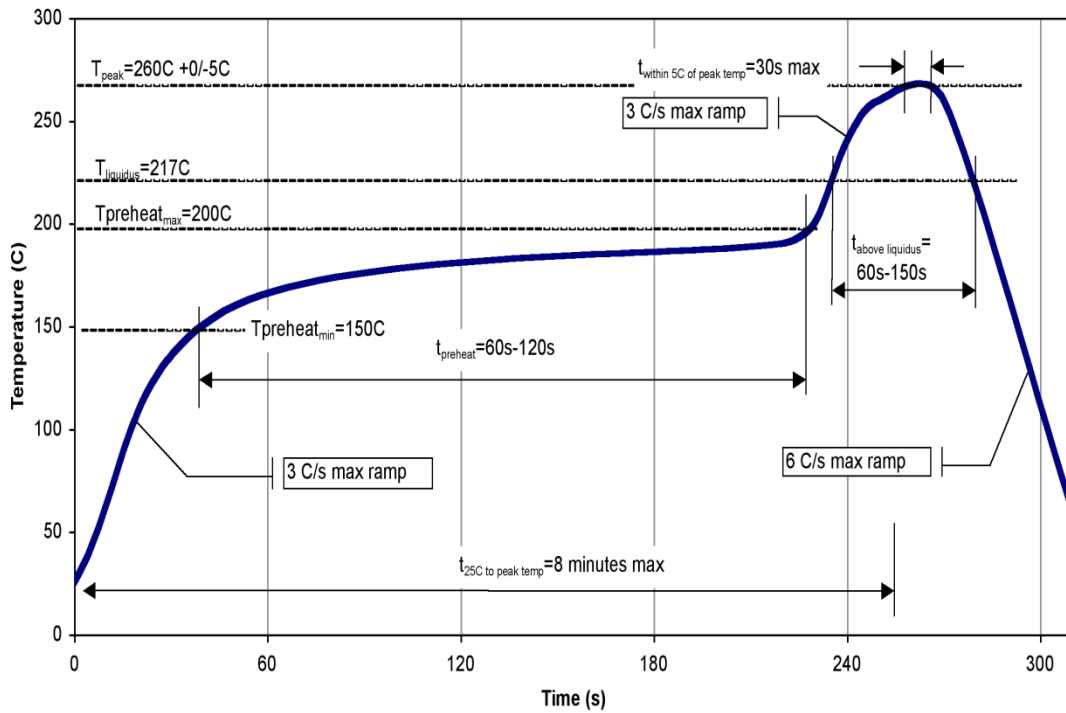

Handling Precautions

Parameter	Rating	Standard
ESD – Human Body Model (HBM)	Class 3B	ESDA / JEDEC JS-001-2012
ESD – Charged Device Model (CDM)	Class C3	JEDEC JESD22-C101F
MSL – Moisture Sensitivity Level	Level 3	IPC/JEDEC J-STD-020



Caution!
 ESD-Sensitive Device

RoHS Compliance

This part is compliant with 2011/65/EU RoHS directive (Restrictions on the Use of Certain Hazardous Substances in Electrical and Electronic Equipment) as amended by Directive 2015/863/EU.

This product also has the following attributes:

- Lead Free
- Antimony Free
- TBBP-A (C₁₅H₁₂Br₄O₂) Free
- PFOS Free

Contact Information

For the latest specifications, additional product information, worldwide sales and distribution locations:

Web: www.qorvo.com

Tel: 1-844-890-8163

Email: customer.support@qorvo.com

Important Notice

The information contained herein is believed to be reliable; however, Qorvo makes no warranties regarding the information contained herein and assumes no responsibility or liability whatsoever for the use of the information contained herein. All information contained herein is subject to change without notice. Customers should obtain and verify the latest relevant information before placing orders for Qorvo products. The information contained herein or any use of such information does not grant, explicitly or implicitly, to any party any patent rights, licenses, or any other intellectual property rights, whether with regard to such information itself or anything described by such information. **THIS INFORMATION DOES NOT CONSTITUTE A WARRANTY WITH RESPECT TO THE PRODUCTS DESCRIBED HEREIN, AND QORVO HEREBY DISCLAIMS ANY AND ALL WARRANTIES WITH RESPECT TO SUCH PRODUCTS WHETHER EXPRESS OR IMPLIED BY LAW, COURSE OF DEALING, COURSE OF PERFORMANCE, USAGE OF TRADE OR OTHERWISE, INCLUDING THE IMPLIED WARRANTIES OF MERCHANTABILITY AND FITNESS FOR A PARTICULAR PURPOSE.**

Without limiting the generality of the foregoing, Qorvo products are not warranted or authorized for use as critical components in medical, life-saving, or life-sustaining applications, or other applications where a failure would reasonably be expected to cause severe personal injury or death.

Copyright 2020 © Qorvo, Inc. | Qorvo is a registered trademark of Qorvo, Inc.

Данный компонент на территории Российской Федерации

Вы можете приобрести в компании MosChip.

Для оперативного оформления запроса Вам необходимо перейти по данной ссылке:

<http://moschip.ru/get-element>

Вы можете разместить у нас заказ для любого Вашего проекта, будь то серийное производство или разработка единичного прибора.

В нашем ассортименте представлены ведущие мировые производители активных и пассивных электронных компонентов.

Нашей специализацией является поставка электронной компонентной базы двойного назначения, продукции таких производителей как XILINX, Intel (ex.ALTERA), Vicor, Microchip, Texas Instruments, Analog Devices, Mini-Circuits, Amphenol, Glenair.

Сотрудничество с глобальными дистрибьюторами электронных компонентов, предоставляет возможность заказывать и получать с международных складов практически любой перечень компонентов в оптимальные для Вас сроки.

На всех этапах разработки и производства наши партнеры могут получить квалифицированную поддержку опытных инженеров.

Система менеджмента качества компании отвечает требованиям в соответствии с ГОСТ Р ИСО 9001, ГОСТ РВ 0015-002 и ЭС РД 009

Офис по работе с юридическими лицами:

105318, г.Москва, ул.Щербаковская д.3, офис 1107, 1118, ДЦ «Щербаковский»

Телефон: +7 495 668-12-70 (многоканальный)

Факс: +7 495 668-12-70 (доб.304)

E-mail: info@moschip.ru

Skype отдела продаж:

moschip.ru

moschip.ru_4

moschip.ru_6

moschip.ru_9