

# 4.7 x 4.1mm BUILT-IN CAPACITANCE CERAMIC RESONATOR

AWSCR-MTD

Pb in ceramic  
(exempt per RoHS 2002/95/EC Annex (7))

**RoHS**  
Compliant



4.7 x 4.1mm

## FEATURES:

- Low resonant impedance
- Built-in load capacitors
- IR reflow capable

## APPLICATIONS:

- Remote controls, Microprocessor clocks, Mobile phones, DVD & CD-Roms, Electric appliances, Industrial controllers
- Consumer electronics

## STANDARD SPECIFICATIONS:

Item	Requirement
Frequency Range	6.00MHz to 50.00MHz
Resonant Impedance	See Table 2.1
Frequency Tolerance	± 0.5%
Frequency Stability max. (-25°C to +85°C)	±0.4% (6.00 MHz~13.00 MHz)* ±0.3% (13.01 MHz~50.00 MHz)
Withstanding Voltage (V)	50 (DC , 1 min)
Rating Voltage (1) D.C.Voltage (2) A.C. Voltage	6 V.D.C. max 15 Vp-p. max
Built-in Capacitance	See Table 2.1
Insulation Resistance	100MΩ min. (10V, 1min)
Operation Temperature	-25°C to +85°C*
Storage Temperature	-55°C to +85°C
Aging Rate (Fosc)	±0.3% max. (10 years)

Table 2.1

Frequency Range (MHz)	Resonant Impedance (Ro)(Ω)	Standard Built-in Capacitance C1=C2 (pF)
6.00 MHz - 13.00 MHz	30	22pF ±20%
13.01 MHz - 16.00 MHz	40	22pF ±20%
16.01 MHz - 25.99 MHz	40	10pF ±20%
26.00 MHz - 50.00 MHz	40	5pF ±20%

\* Please contact ABRACON for tighter stability and/or wider temperature range

## TEST CIRCUIT:

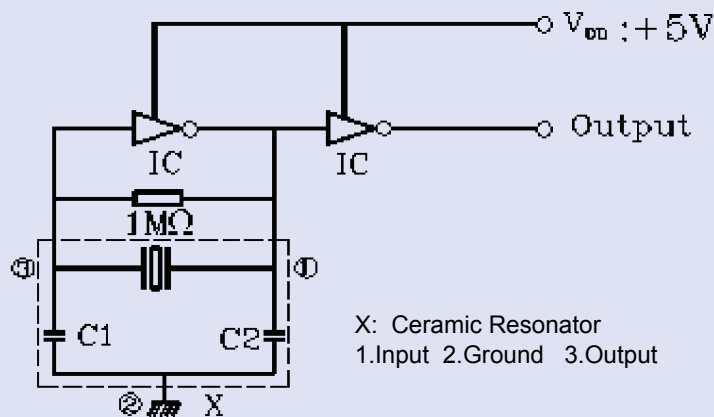

Parts shall be measured under a condition (Temp.: 20±15°C, Humidity: 65±20% R.H.) unless the standard condition (Temp: 25±3°C, Humidity: 65±10% R.H.) is regulated to measure

## OPTIONS AND PART IDENTIFICATION:

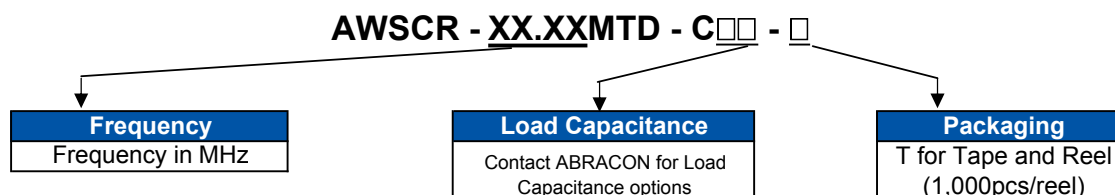

# 4.7 x 4.1mm BUILT-IN CAPACITANCE CERAMIC RESONATOR

AWSCR-MTD

Pb in ceramic  
(exempt per RoHS 2002/95/EC Annex (7))

**RoHS**  
Compliant



4.7 x 4.1mm

## OUTLINE DRAWING:

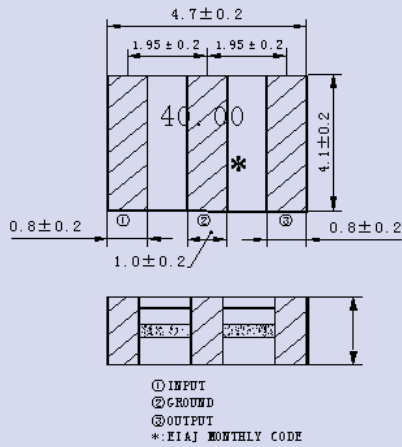

## RECOMMENDED LAND PATTERN

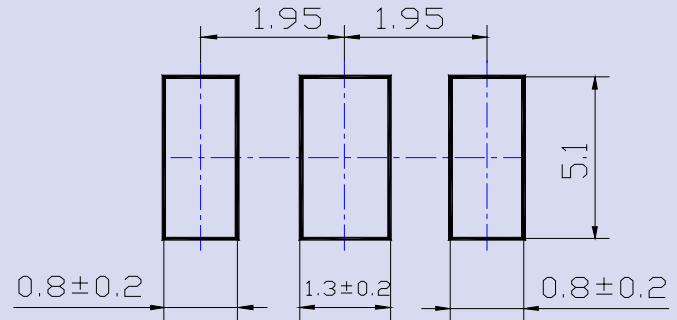

Dimension : mm

## TAPE & REEL: [1,000pcs/reel]

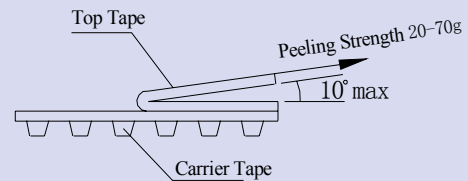
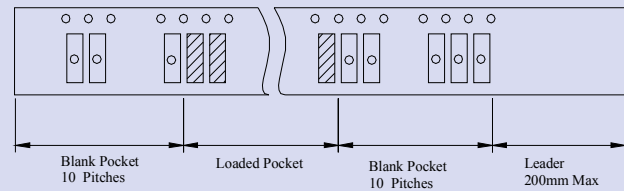
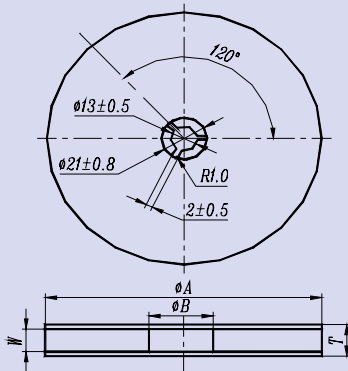

φ A	φ B	W	T	Pieces per reel	Carrier tape size
180±3	60min	12.4min	19.4max	1000typ.	12

Dimension : mm

# 4.7 x 4.1mm BUILT-IN CAPACITANCE CERAMIC RESONATOR

AWSCR-MTD

Pb in ceramic  
(exempt per RoHS 2002/95/EC Annex (7))

**RoHS**  
Compliant



4.7 x 4.1mm

## REFLOW PROFILE:

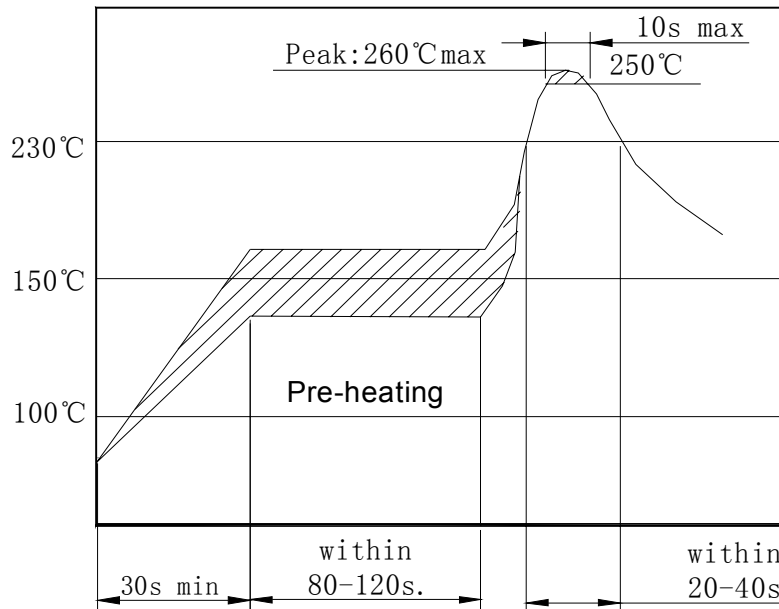

## CAUTION

- Do not apply excess mechanical stress to the component body or terminations. Do not attempt to re-form or bend the components as this will cause damage to the component.
- This component is not hermetically sealed. Do not clean or wash the component.
- Reflow soldering: Do not use strong acidity flux, such as flux with chlorine content of greater than 0.2wt% during reflow Soldering.
- Do not expose the component to open flame.
- This specification applies to the functionality of the component as a single unit. Customers are advised to insure that the component is thoroughly evaluated in the particular application.
- Shelf life: The warranted shelf life of this product is six months after the delivery date under the conditions of sealed, unopened, original packaging.
- Storage conditions: If the product is to be stored for a period greater than six months after the delivery date, it is recommended that customers confirm the solderability and characteristics for the product prior to use.
- This product is not recommended for use in the following applications: Automotive, Medical, Military, Safety, or any other high-reliability, life-dependant application. Contact Abracon Corporation prior to using this product when in doubt.

**ATTENTION:** Abracon Corporation's products are COTS - Commercial-Off-The-Shelf products; suitable for Commercial, Industrial and, where designated, Automotive Applications. Abracon's products are not specifically designed for Military, Aviation, Aerospace, Life-dependant Medical applications or any application requiring high reliability where component failure could result in loss of life and/or property. For applications requiring high reliability and/or presenting an extreme operating environment, written consent and authorization from Abracon Corporation is required. Please contact Abracon Corporation for more information.

ABRACON IS  
ISO9001:2008  
CERTIFIED



Visit [www.abracon.com](http://www.abracon.com) for Terms & Conditions of Sale **Revised: 09.12.10**  
30332 Esperanza, Rancho Santa Margarita, California 92688  
tel 949-546-8000 | fax 949-546-8001 | [www.abracon.com](http://www.abracon.com)

## Данный компонент на территории Российской Федерации

### Вы можете приобрести в компании MosChip.

Для оперативного оформления запроса Вам необходимо перейти по данной ссылке:

<http://moschip.ru/get-element>

Вы можете разместить у нас заказ для любого Вашего проекта, будь то серийное производство или разработка единичного прибора.

В нашем ассортименте представлены ведущие мировые производители активных и пассивных электронных компонентов.

Нашей специализацией является поставка электронной компонентной базы двойного назначения, продукции таких производителей как XILINX, Intel (ex.ALTERA), Vicor, Microchip, Texas Instruments, Analog Devices, Mini-Circuits, Amphenol, Glenair.

Сотрудничество с глобальными дистрибьюторами электронных компонентов, предоставляет возможность заказывать и получать с международных складов практически любой перечень компонентов в оптимальные для Вас сроки.

На всех этапах разработки и производства наши партнеры могут получить квалифицированную поддержку опытных инженеров.

Система менеджмента качества компании отвечает требованиям в соответствии с ГОСТ Р ИСО 9001, ГОСТ РВ 0015-002 и ЭС РД 009

### Офис по работе с юридическими лицами:

105318, г.Москва, ул.Щербаковская д.3, офис 1107, 1118, ДЦ «Щербаковский»

Телефон: +7 495 668-12-70 (многоканальный)

Факс: +7 495 668-12-70 (доб.304)

E-mail: [info@moschip.ru](mailto:info@moschip.ru)

Skype отдела продаж:

moschip.ru

moschip.ru\_4

moschip.ru\_6

moschip.ru\_9