

## Inverter Grade Thyristors (Hockey PUK Version), 940 A



TO-200AC (B-PUK)

### FEATURES

- Metal case with ceramic insulator
- All diffused design
- Center amplifying gate
- Guaranteed high dV/dt
- Guaranteed high dI/dt
- International standard case TO-200AC (B-PUK)
- High surge current capability
- Low thermal impedance
- High speed performance
- Designed and qualified for industrial level
- Material categorization: for definitions of compliance please see [www.vishay.com/doc?99912](http://www.vishay.com/doc?99912)



**RoHS  
COMPLIANT**

PRODUCT SUMMARY	
Package	TO-200AC (B-PUK)
Diode variation	Single SCR
$I_{T(AV)}$	940 A
$V_{DRM}/V_{RRM}$	400 V, 800 V
$V_{TM}$	1.63 V
$I_{TSM}$ at 50 Hz	20 000 A
$I_{TSM}$ at 60 Hz	20 950 A
$I_{GT}$	200 mA
$T_C/T_{hs}$	55 °C

### TYPICAL APPLICATIONS

- Inverters
- Choppers
- Induction heating
- All types of force-commutated converters

MAJOR RATINGS AND CHARACTERISTICS			
PARAMETER	TEST CONDITIONS	VALUES	UNITS
$I_{T(AV)}$		940	A
	$T_{hs}$	55	°C
$I_{T(RMS)}$		1900	A
	$T_{hs}$	25	°C
$I_{TSM}$	50 Hz	20 000	A
	60 Hz	20 950	
$I^2t$	50 Hz	2000	kA <sup>2</sup> s
	60 Hz	1820	
$V_{DRM}/V_{RRM}$		400 to 800	V
$t_q$	Range	10 to 20	µs
$T_J$		-40 to +125	°C

### ELECTRICAL SPECIFICATIONS

VOLTAGE RATINGS				
TYPE NUMBER	VOLTAGE CODE	$V_{DRM}/V_{RRM}$ , MAXIMUM REPETITIVE PEAK VOLTAGE V	$V_{RSM}$ , MAXIMUM NON-REPETITIVE PEAK VOLTAGE V	$I_{DRM}/I_{RRM}$ MAXIMUM AT $T_J = T_J$ MAXIMUM mA
VS-ST733C..L	04	400	500	75
	08	800	900	



CURRENT CARRYING CAPABILITY							
FREQUENCY							UNITS
50 Hz	2200	1900	3580	3100	6800	5920	A
400 Hz	2050	1660	3600	3130	3750	3240	
1000 Hz	1370	1070	2900	2450	2120	1780	
2500 Hz	500	370	1220	980	960	770	
Recovery voltage $V_R$	50		50		50		V
Voltage before turn-on $V_D$	$V_{DRM}$		$V_{DRM}$		$V_{DRM}$		
Rise of on-state current $di/dt$	50		-		-		A/ $\mu$ s
Heatsink temperature	40	55	40	55	40	55	$^{\circ}$ C
Equivalent values for RC circuit	10/0.47		10/0.47		10/0.47		$\Omega/\mu$ F

ABSOLUTE MAXIMUM RATINGS					
PARAMETER	SYMBOL	TEST CONDITIONS		VALUES	UNITS
Maximum average on-state current at heatsink temperature	$I_{T(AV)}$	180 $^{\circ}$ conduction, half sine wave double side (single side) cooled		940 (350)	A
				55 (85)	$^{\circ}$ C
Maximum RMS on-state current	$I_{T(RMS)}$	DC at 25 $^{\circ}$ C heatsink temperature double side cooled		1900	A
Maximum peak, one half cycle, non-repetitive surge current	$I_{TSM}$	t = 10 ms	No voltage reappplied	20 000	
		t = 8.3 ms		20 950	
		t = 10 ms	100 % $V_{RRM}$ reappplied	16 800	
		t = 8.3 ms		17 600	
Maximum $I^2t$ for fusing	$I^2t$	t = 10 ms	No voltage reappplied	2000	kA $^2$ s
		t = 8.3 ms		1820	
		t = 10 ms	100 % $V_{RRM}$ reappplied	1410	
		t = 8.3 ms		1290	
Maximum $I^2\sqrt{t}$ for fusing	$I^2\sqrt{t}$	t = 0.1 ms to 10 ms, no voltage reappplied		20 000	kA $^2\sqrt{s}$
Maximum peak on-state voltage	$V_{TM}$	$I_{TM} = 1700$ A, $T_J = T_J$ maximum, $t_p = 10$ ms sine wave pulse		1.63	V
Low level value of threshold voltage	$V_{T(TO)1}$	$(16.7 \% \times \pi \times I_{T(AV)} < I < \pi \times I_{T(AV)})$ , $T_J = T_J$ maximum		1.09	
High level value of threshold voltage	$V_{T(TO)2}$	$(I > \pi \times I_{T(AV)})$ , $T_J = T_J$ maximum		1.20	
Low level value of forward slope resistance	$r_{t1}$	$(16.7 \% \times \pi \times I_{T(AV)} < I < \pi \times I_{T(AV)})$ , $T_J = T_J$ maximum		0.32	m $\Omega$
High level value of forward slope resistance	$r_{t2}$	$(I > \pi \times I_{T(AV)})$ , $T_J = T_J$ maximum		0.29	
Maximum holding current	$I_H$	$T_J = 25$ $^{\circ}$ C, $I_T > 30$ A		600	mA
Typical latching current	$I_L$	$T_J = 25$ $^{\circ}$ C, $V_A = 12$ V, $R_a = 6$ $\Omega$ , $I_G = 1$ A		1000	



SWITCHING				
PARAMETER	SYMBOL	TEST CONDITIONS	VALUES	UNITS
Maximum non-repetitive rate of rise of turned-on current	dl/dt	$T_J = T_J$ maximum, $V_{DRM} = \text{Rated } V_{DRM}$ , $I_{TM} = 2 \times dl/dt$ Gate pulse: 20 V 20 $\Omega$ , 10 $\mu$ s 0.5 $\mu$ s rise time	1000	A/ $\mu$ s
Typical delay time	$t_d$	$T_J = 25^\circ\text{C}$ , $V_{DM} = \text{Rated } V_{DRM}$ , $I_{TM} = 50$ A DC, $t_p = 1$ $\mu$ s Resistive load, gate pulse: 10 V, 5 $\Omega$ source	1.5	$\mu$ s
Maximum turn-off time	minimum	$T_J = T_J$ maximum, $I_{TM} = 550$ A, commutating $dl/dt = 40$ A/ $\mu$ s, $V_R = 50$ V, $t_p = 500$ $\mu$ s, $dV/dt$ : see table in device code	10	
	maximum		20	

BLOCKING				
PARAMETER	SYMBOL	TEST CONDITIONS	VALUES	UNITS
Maximum critical rate of rise of off-state voltage	dV/dt	$T_J = T_J$ maximum, linear to 80 % $V_{DRM}$ , higher value available on request	500	V/ $\mu$ s
Maximum peak reverse and off-state leakage current	$I_{RRM}$ , $I_{DRM}$	$T_J = T_J$ maximum, rated $V_{DRM}/V_{RRM}$ applied	75	mA

TRIGGERING				
PARAMETER	SYMBOL	TEST CONDITIONS	VALUES	UNITS
Maximum peak gate power	$P_{GM}$	$T_J = T_J$ maximum, $f = 50$ Hz, $d\% = 50$	60	W
Maximum average gate power	$P_{G(AV)}$		10	
Maximum peak positive gate current	$I_{GM}$	$T_J = T_J$ maximum, $t_p \leq 5$ ms	10	A
Maximum peak positive gate voltage	+ $V_{GM}$		20	V
Maximum peak negative gate voltage	- $V_{GM}$		5	
Maximum DC gate current required to trigger	$I_{GT}$	$T_J = 25^\circ\text{C}$ , $V_A = 12$ V, $R_a = 6$ $\Omega$	200	mA
Maximum DC gate voltage required to trigger	$V_{GT}$		3	V
Maximum DC gate current not to trigger	$I_{GD}$	$T_J = T_J$ maximum, rated $V_{DRM}$ applied	20	mA
Maximum DC gate voltage not to trigger	$V_{GD}$		0.25	V

THERMAL AND MECHANICAL SPECIFICATIONS				
PARAMETER	SYMBOL	TEST CONDITIONS	VALUES	UNITS
Maximum operating junction temperature range	$T_J$		-40 to +125	$^\circ\text{C}$
Maximum storage temperature range	$T_{Stg}$		-40 to +150	
Maximum thermal resistance, junction to heatsink	$R_{thJ-hs}$	DC operation single side cooled	0.073	K/W
		DC operation double side cooled	0.031	
Maximum thermal resistance, case to heatsink	$R_{thC-hs}$	DC operation single side cooled	0.011	
		DC operation double side cooled	0.005	
Mounting force, $\pm 10$ %			14 700 (1500)	N (kg)
Approximate weight			255	g
Case style		See dimensions - link at the end of datasheet	TO-200AC (B-PUK)	



<b><math>\Delta R_{thJ-hs}</math> CONDUCTION</b>						
CONDUCTION ANGLE	SINUSOIDAL CONDUCTION		RECTANGULAR CONDUCTION		TEST CONDITIONS	UNITS
	SINGLE SIDE	DOUBLE SIDE	SINGLE SIDE	DOUBLE SIDE		
180°	0.009	0.009	0.006	0.006	T <sub>J</sub> = T <sub>J</sub> maximum	K/W
120°	0.011	0.011	0.011	0.011		
90°	0.014	0.014	0.015	0.015		
60°	0.020	0.021	0.021	0.022		
30°	0.036	0.036	0.036	0.036		

**Note**

- The table above shows the increment of thermal resistance  $R_{thJ-hs}$  when devices operate at different conduction angles than DC

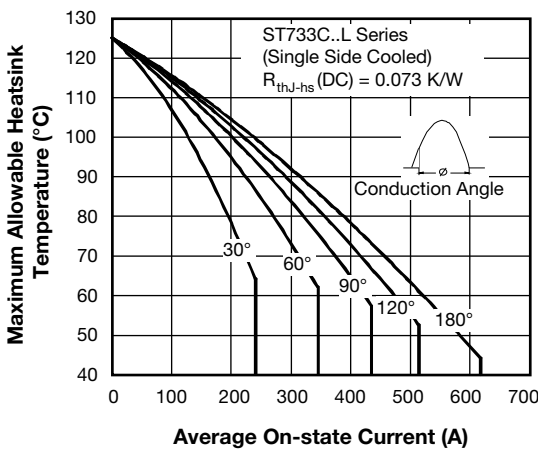

Fig. 1 - Current Ratings Characteristics

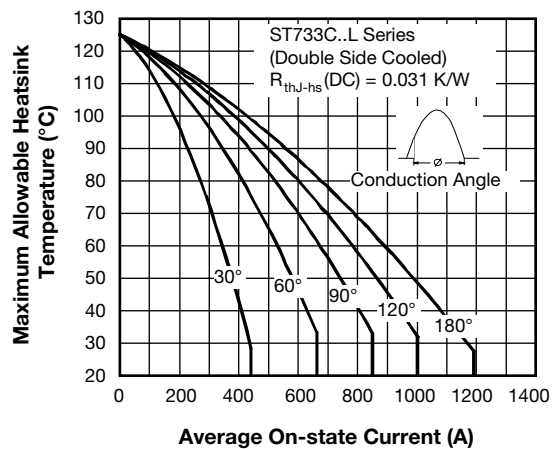

Fig. 3 - Current Ratings Characteristics

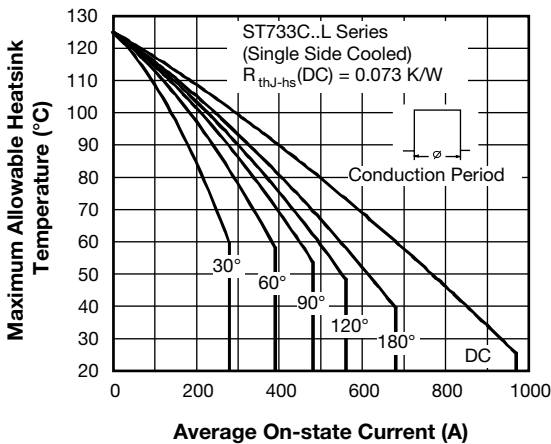

Fig. 2 - Current Ratings Characteristics

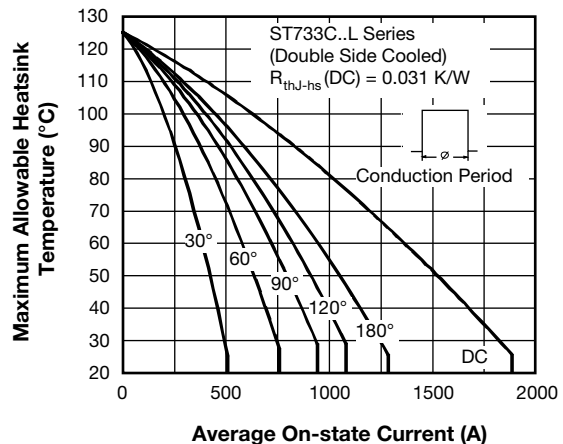

Fig. 4 - Current Ratings Characteristics

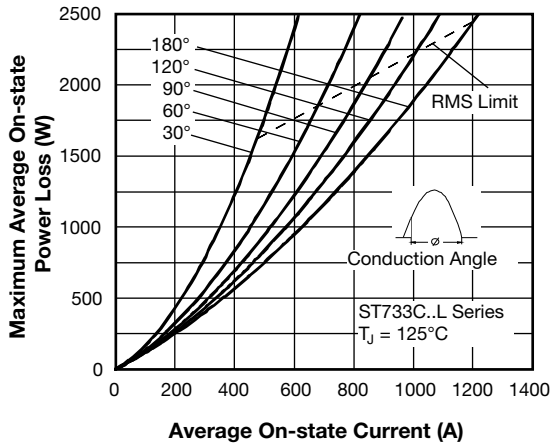

Fig. 5 - On-State Power Loss Characteristics

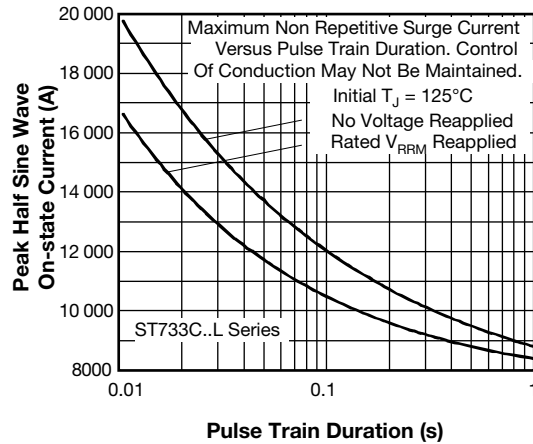

Fig. 8 - Maximum Non-Repetitive Surge Current Single and Double Side Cooled

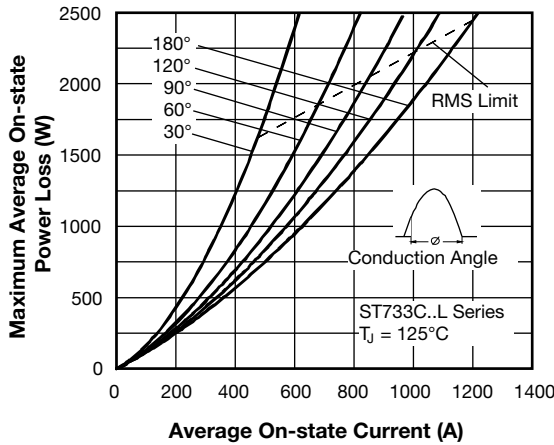

Fig. 6 - On-State Power Loss Characteristics

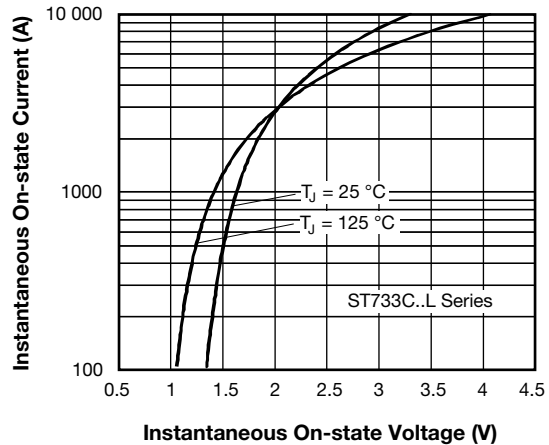

Fig. 9 - On-State Voltage Drop Characteristics

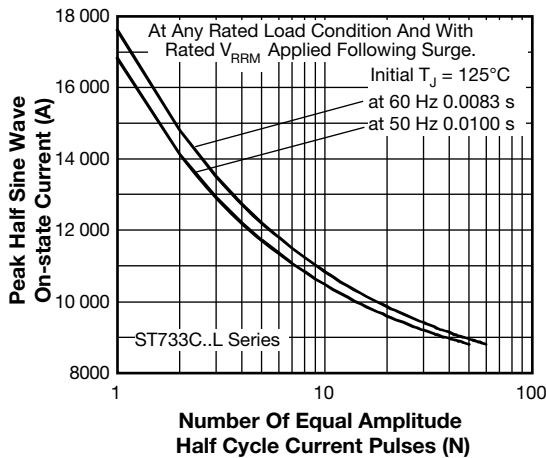

Fig. 7 - Maximum Non-Repetitive Surge Current Single and Double Side Cooled

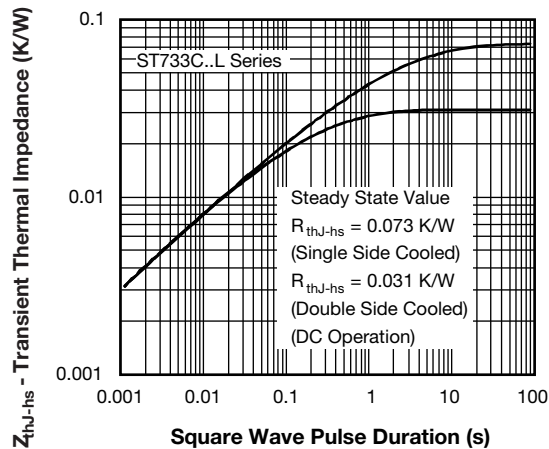

Fig. 10 - Thermal Impedance  $Z_{thJC}$  Characteristics

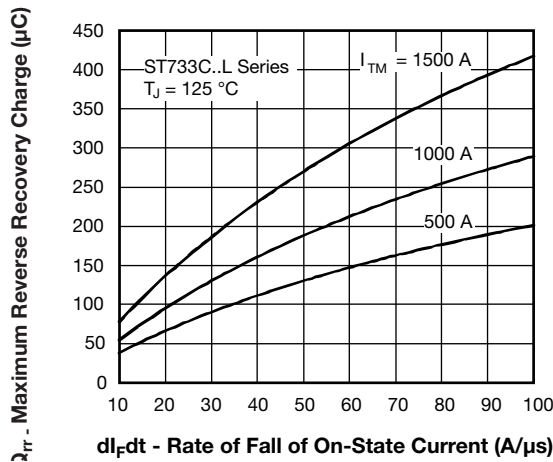

Fig. 11 - Reverse Recovered Charge Characteristics

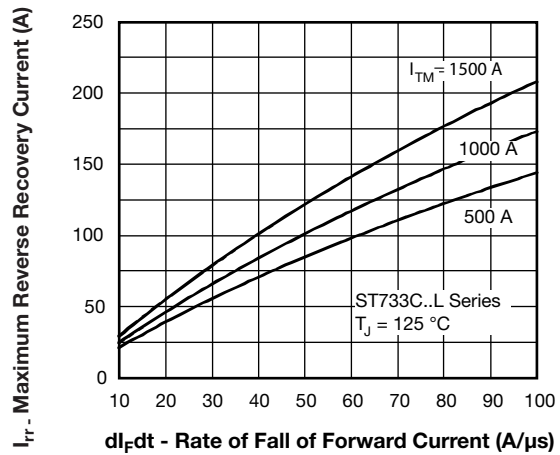

Fig. 12 - Reverse Recovered Current Characteristics

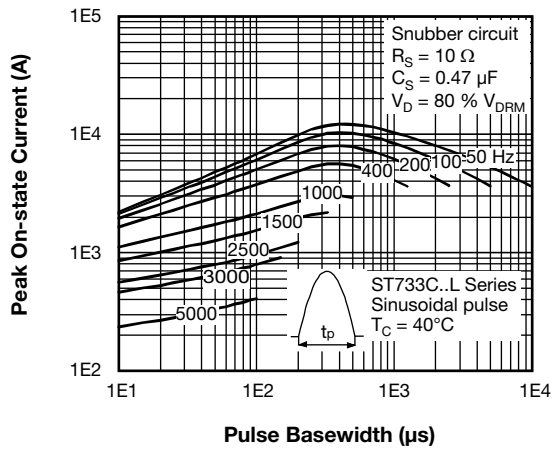

Fig. 13 - Frequency Characteristics

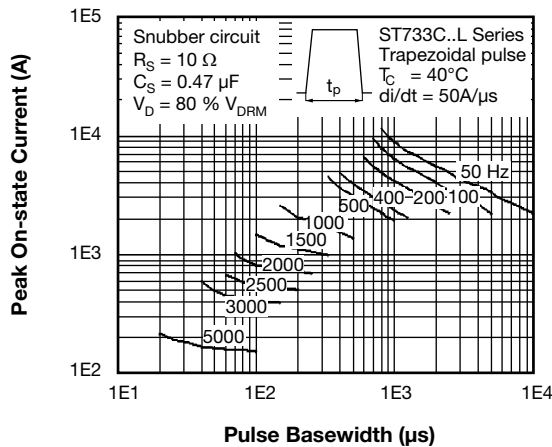
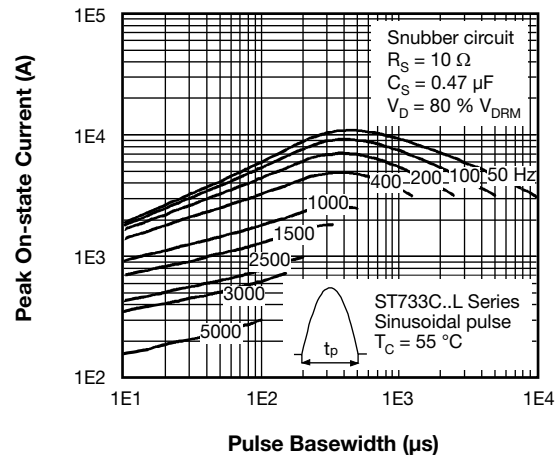
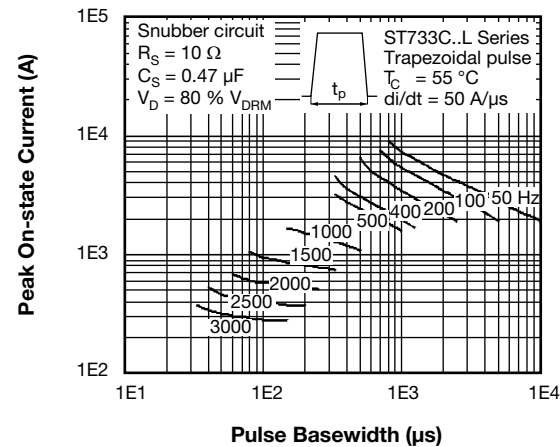

Fig. 14 - Frequency Characteristics



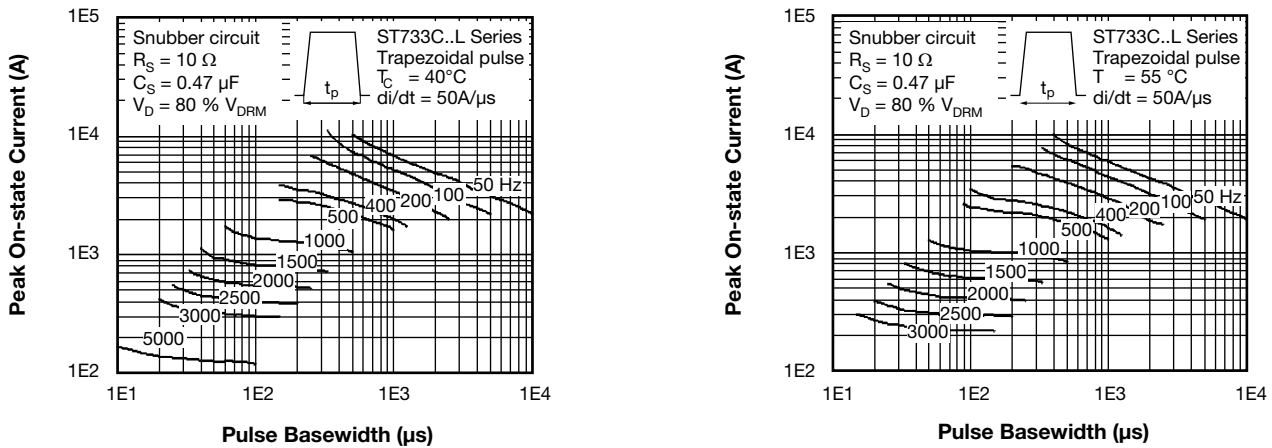

Fig. 15 - Frequency Characteristics

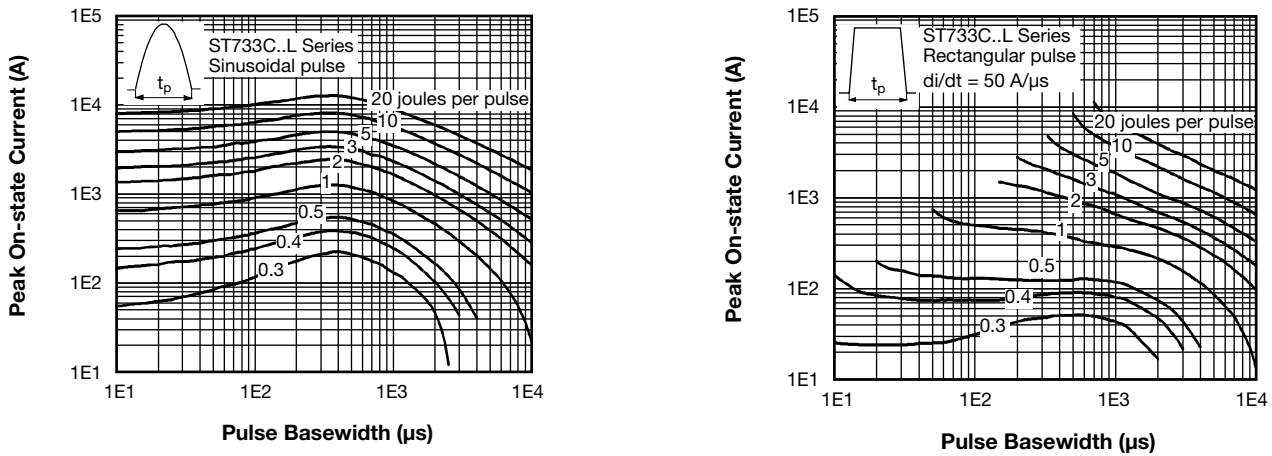

Fig. 16 - Maximum On-State Energy Power Loss Characteristics

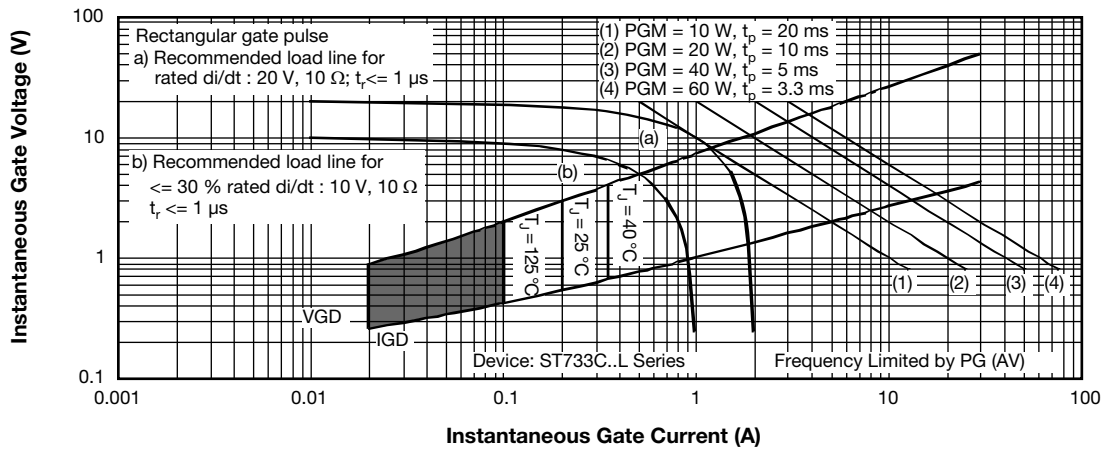

Fig. 17 - Gate Characteristics



**ORDERING INFORMATION TABLE**

Device code	<b>VS-</b>	<b>ST</b>	<b>73</b>	<b>3</b>	<b>C</b>	<b>08</b>	<b>L</b>	<b>H</b>	<b>K</b>	<b>1</b>	<b>-</b>
	①	②	③	④	⑤	⑥	⑦	⑧	⑨	⑩	⑪

- 1** - Vishay Semiconductors product
- 2** - Thyristor
- 3** - Essential part number
- 4** - 3 = fast turn-off
- 5** - C = ceramic PUK
- 6** - Voltage code x 100 =  $V_{RRM}$   
(see Voltage Ratings table)
- 7** - L = PUK case TO-200AC (B-PUK)
- 8** - Reapplied dV/dt code (for  $t_q$  test condition)
- 9** -  $t_q$  code
- 10** - 0 = eyelet terminals  
(gate and auxiliary cathode unsoldered leads)  
1 = fast-on terminals  
(gate and auxiliary cathode unsoldered leads)  
2 = eyelet terminals  
(gate and auxiliary cathode soldered leads)  
3 = fast-on terminals  
(gate and auxiliary cathode soldered leads)
- 11** - Critical dV/dt:
  - None = 500 V/ $\mu$ s (standard value)
  - L = 1000 V/ $\mu$ s (special selection)

dV/dt - $t_q$ combinations available						
	dV/dt (V/ $\mu$ s)	20	50	100	200	400
$t_q$ ( $\mu$ s)	10	CN	DN	EN	-	-
	12	CM	DM	EM	FM*	-
	15	CL	DL	EL	FL*	HL
	18	CP	DP	EP	FP	HP
	20	CK	DK	EK	FK	H

\* Standard part number.  
All other types available only on request.

LINKS TO RELATED DOCUMENTS	
Dimensions	<a href="http://www.vishay.com/doc?95076">www.vishay.com/doc?95076</a>



## TO-200AC (B-PUK)

**DIMENSIONS** in millimeters (inches)

Creepage distance: 36.33 (1.430) minimum  
 Strike distance: 17.43 (0.686) minimum

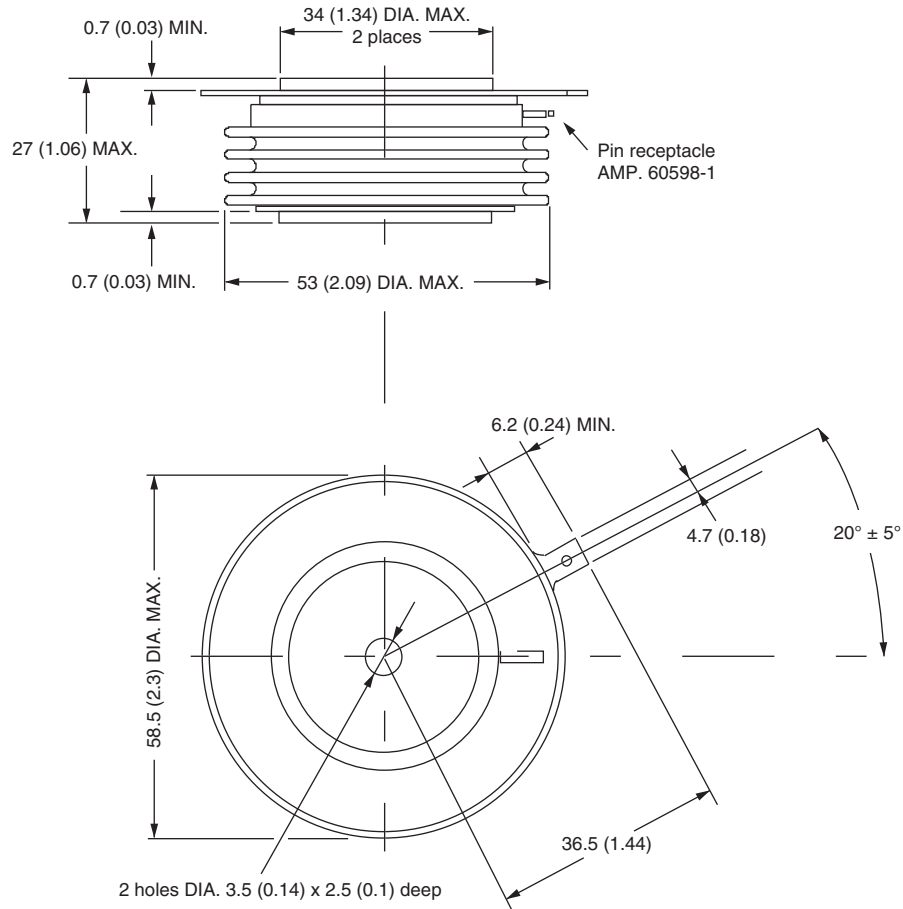

Quote between upper and lower pole pieces has to be considered after application of mounting force (see thermal and mechanical specification)



## Disclaimer

ALL PRODUCT, PRODUCT SPECIFICATIONS AND DATA ARE SUBJECT TO CHANGE WITHOUT NOTICE TO IMPROVE RELIABILITY, FUNCTION OR DESIGN OR OTHERWISE.

Vishay Intertechnology, Inc., its affiliates, agents, and employees, and all persons acting on its or their behalf (collectively, "Vishay"), disclaim any and all liability for any errors, inaccuracies or incompleteness contained in any datasheet or in any other disclosure relating to any product.

Vishay makes no warranty, representation or guarantee regarding the suitability of the products for any particular purpose or the continuing production of any product. To the maximum extent permitted by applicable law, Vishay disclaims (i) any and all liability arising out of the application or use of any product, (ii) any and all liability, including without limitation special, consequential or incidental damages, and (iii) any and all implied warranties, including warranties of fitness for particular purpose, non-infringement and merchantability.

Statements regarding the suitability of products for certain types of applications are based on Vishay's knowledge of typical requirements that are often placed on Vishay products in generic applications. Such statements are not binding statements about the suitability of products for a particular application. It is the customer's responsibility to validate that a particular product with the properties described in the product specification is suitable for use in a particular application. Parameters provided in datasheets and/or specifications may vary in different applications and performance may vary over time. All operating parameters, including typical parameters, must be validated for each customer application by the customer's technical experts. Product specifications do not expand or otherwise modify Vishay's terms and conditions of purchase, including but not limited to the warranty expressed therein.

Except as expressly indicated in writing, Vishay products are not designed for use in medical, life-saving, or life-sustaining applications or for any other application in which the failure of the Vishay product could result in personal injury or death. Customers using or selling Vishay products not expressly indicated for use in such applications do so at their own risk. Please contact authorized Vishay personnel to obtain written terms and conditions regarding products designed for such applications.

No license, express or implied, by estoppel or otherwise, to any intellectual property rights is granted by this document or by any conduct of Vishay. Product names and markings noted herein may be trademarks of their respective owners.

## Material Category Policy

**Vishay Intertechnology, Inc. hereby certifies that all its products that are identified as RoHS-Compliant fulfill the definitions and restrictions defined under Directive 2011/65/EU of The European Parliament and of the Council of June 8, 2011 on the restriction of the use of certain hazardous substances in electrical and electronic equipment (EEE) - recast, unless otherwise specified as non-compliant.**

**Please note that some Vishay documentation may still make reference to RoHS Directive 2002/95/EC. We confirm that all the products identified as being compliant to Directive 2002/95/EC conform to Directive 2011/65/EU.**

**Vishay Intertechnology, Inc. hereby certifies that all its products that are identified as Halogen-Free follow Halogen-Free requirements as per JEDEC JS709A standards. Please note that some Vishay documentation may still make reference to the IEC 61249-2-21 definition. We confirm that all the products identified as being compliant to IEC 61249-2-21 conform to JEDEC JS709A standards.**

## Данный компонент на территории Российской Федерации

### Вы можете приобрести в компании MosChip.

Для оперативного оформления запроса Вам необходимо перейти по данной ссылке:

<http://moschip.ru/get-element>

Вы можете разместить у нас заказ для любого Вашего проекта, будь то серийное производство или разработка единичного прибора.

В нашем ассортименте представлены ведущие мировые производители активных и пассивных электронных компонентов.

Нашей специализацией является поставка электронной компонентной базы двойного назначения, продукции таких производителей как XILINX, Intel (ex.ALTERA), Vicor, Microchip, Texas Instruments, Analog Devices, Mini-Circuits, Amphenol, Glenair.

Сотрудничество с глобальными дистрибьюторами электронных компонентов, предоставляет возможность заказывать и получать с международных складов практически любой перечень компонентов в оптимальные для Вас сроки.

На всех этапах разработки и производства наши партнеры могут получить квалифицированную поддержку опытных инженеров.

Система менеджмента качества компании отвечает требованиям в соответствии с ГОСТ Р ИСО 9001, ГОСТ РВ 0015-002 и ЭС РД 009

### Офис по работе с юридическими лицами:

105318, г.Москва, ул.Щербаковская д.3, офис 1107, 1118, ДЦ «Щербаковский»

Телефон: +7 495 668-12-70 (многоканальный)

Факс: +7 495 668-12-70 (доб.304)

E-mail: [info@moschip.ru](mailto:info@moschip.ru)

Skype отдела продаж:

moschip.ru

moschip.ru\_4

moschip.ru\_6

moschip.ru\_9