



har-flex^o straight male connector



GENERAL INFORMATIONS

No. of contacts	from 6 to 100poles, all even numbers
Contact spacing	1,27mm x 1,27mm [0,050"x0,050"]
Test Voltage	500V
Contact resistance	< 25 mOhm
Insulation resistance	≥ 10x10 ⁹ Ω
Working current acc. to IEC 60512, at 70°C, 80% derating	see derating diagram
Working temperature range	-55°C ... +125°C
Termination technology	SMT
Reflow processing temperature (acc. to ECA/IPC/JEDEC J-STD-075 Level PSL R0)	min. 150s >217°C min. 30s >240°C
Clearance & creepage distance	0,4mm min.
Insertion force (depending on mating connector)	approximately 0,5N/contact
Withdrawal force (depending on mating connector)	approximately 0,5N/contact
Mating cycles	PL1 : 500 mating cycles PL2 : 250 mating cycles
RoHS - compliant	Yes
Leadfree	Yes
Working voltage acc. to IEC 60664-1	100V / 150V (depending on installation category)
UL file acc. UL 1977	ECBT2.E102079
UL file acc. CSA-C22.2 (for Canada)	ECBT8.E102079
PSL level acc. ECA/IPC/JEDEC J-STD-075	PSL R0
MSL level acc. ECA/IPC/JEDEC J-STD-020D	MSL 1

INSULATOR MATERIAL

Material	LCP (liquid crystalline polymer)
Color	Black
UL classification	UL94-V0
Material group acc. IEC 60664-1	IIIa (175 ≤ CTI < 400)

CONTACT MATERIAL

Contact material	Copper alloy
Plating termination zone	Sn
Plating contact sliding side	Au over PdNi (acc. to Performance level)

DERATING DIAGRAM acc. to IEC 60512-5 (Current carrying capacity)

The current carrying capacity is limited by maximum temperature of materials for inserts and contacts including terminals.
The current capacity curve is valid for continuous, non interrupted current loaded contacts of connectors when simultaneous power on all contacts is given, without exceeding the maximum temperature.

Control and test procedures according to DIN IEC 60512-5

derating curve at I_{max}*0,8 (IEC 60512-5-2)

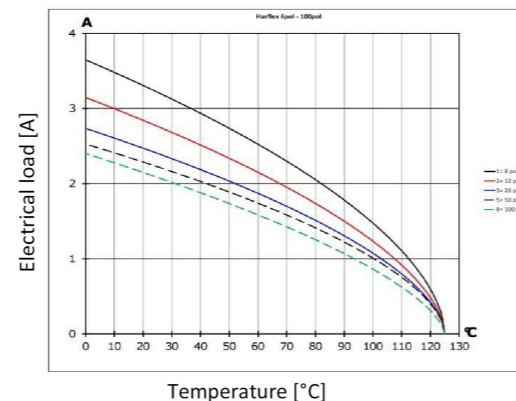

RECOMMENDATION FOR SOLDER PROCESSING

Solder paste recommendation

The har-flex connectors are solderable with established lead-free SAC / SnNi solder but also leaded solder e.g. SnPb40

PCB pad plating

The har-flex connectors are solderable on lead-free pad surfaces like HAL, NiAu, Immersion Sn.

Stencil recommendation

The solder deposition has to be placed on the pad area of the contact solder tines. Ideally, the solder deposition has the same length-to-width ratio and center point like the PCB pads. The size of the solder stencil apertures is depending on the thickness of the stencil. In general, the thinner stencils will need larger apertures to result in the required volume of solder paste. The minimum required solder paste volume for the signal pins is 0,094mm³, for the hold down it is 0,33mm³. For example, this can be achieved with the following stencil data :

Signal pins			
Stencil thickness	PCB pad size	proposal stencil aperture size	calculated solder paste volume
120 μm	1,1 x 0,8 mm	1,05 x 0,75 mm	0,095 mm ³
150 μm	1,1 x 0,8 mm	0,99 x 0,72 mm	0,107 mm ³
Hold-downs			
Stencil thickness	PCB pad size	proposal stencil aperture size	calculated solder paste volume
120 μm	2,5 x 1,2 mm	2,45 x 1,15 mm	0,338 mm ³
150 μm	2,5 x 1,2 mm	2,25 x 1,08 mm	0,365 mm ³

If a stencil with lower thickness shall be used, please insure the minimum required solder paste volume by enlarging the stencil aperture. Depending on the PCB design, the solder deposition may protrude the PCB pads. But to achieve a good sealing during solder paste printing and to reduce the cleaning interval of the stencil, the aperture should be smaller than the PCB pad about 10% or 25μm encircling.

Coplanarity of contacts

All connectors are tested for coplanarity of contacts and are in the range of 6 pin to 80 pin: ≤ 0,1mm
82 pin to 100 pin: ≤ 0,15mm

Performance level

Performance level 1 (recommended for majority of applications)
Initial 250 mating cycles, 10 days gas test (25°C / 75% r.h.) using H2S 10 ppb, NO2 200 ppb, CL2 10 ppb, SO2 200 ppb. Measurement of contact resistance. The remaining 250 mating cycles are subject to measurement of contact resistance and visual inspection.

Visual inspection. No abrasion of the contact finish through to the base material. No functional impairment.

Part number definition : 15 2

Performance level 2

Initial 125 mating cycles, 4 days gas test (25°C / 75% r.h.) using H2S 10 ppb, NO2 200 ppb, CL2 10 ppb, SO2 200 ppb. Measurement of contact resistance. The remaining 125 mating cycles are subject to measurement of contact resistance and visual inspection.

Visual inspection. No abrasion of the contact finish through to the base material. No functional impairment.

Part number definition : 15 6

Performance level S4

Defined contact surface of min. 0,06 μm Au over 0,7+0,2μm PdNi

Part number definition : 15 5

	All Dimensions in mm Original Size DIN A3	Scale 1:1	Free size tol.	Ref.
	All rights reserved Department EC PD - CN	Created by ZHUANGJ	Inspected by LUOK	Standardisation HOFFMANN
		Date 2018-05-21	State Final Release	
		Title har flex male stacking height1.75 and 3.25		Doc-Key / ECM-Nr. 100577896/UGD/001/B 500000135280
HARTING Electronics GmbH D-32339 Espelkamp		Type DS	Number 15111100301	Rev. B Page 1/2



har-flex straight male connector



TAPE LAYOUT & PACKAGING

Tape acc. to IEC 60286-3

Reel off direction →



Tape dimensions:	A	F	I	K
poles 06 to 12	24,0	11,5±0,1	-	2±0,1
poles 14 to 20	32,0	14,2±0,1	28,4	2±0,1
poles 22 to 40	44,0	20,2±0,15	40,4	2±0,15
poles 42 to 56	56,0	26,2±0,15	52,4	2±0,15
poles 58 to 80	72,0	34,2±0,3	68,4	2±0,2
poles 82 to 100	88,0	42,2±0,3	84,4	2±0,2

① NO DOUBLE SPROCKET HOLES FOR 06, 08, 10 AND 12 POLE NUMBERS (TAPE SIZE 24)

Pick & place pad 6,4±0,1 x 4,5±0,1

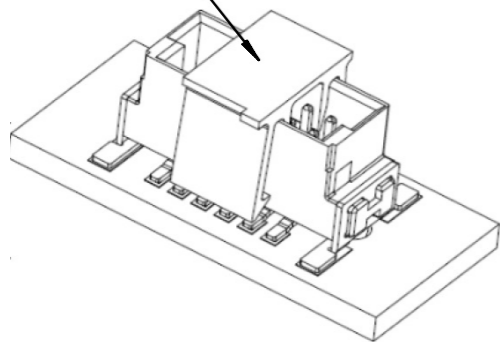

Packaging indices ("XXX" in part number)

Index	Packaging unit	Packaging
000	280	Tape & reel
333	1	Tape

REEL DIMENSIONS

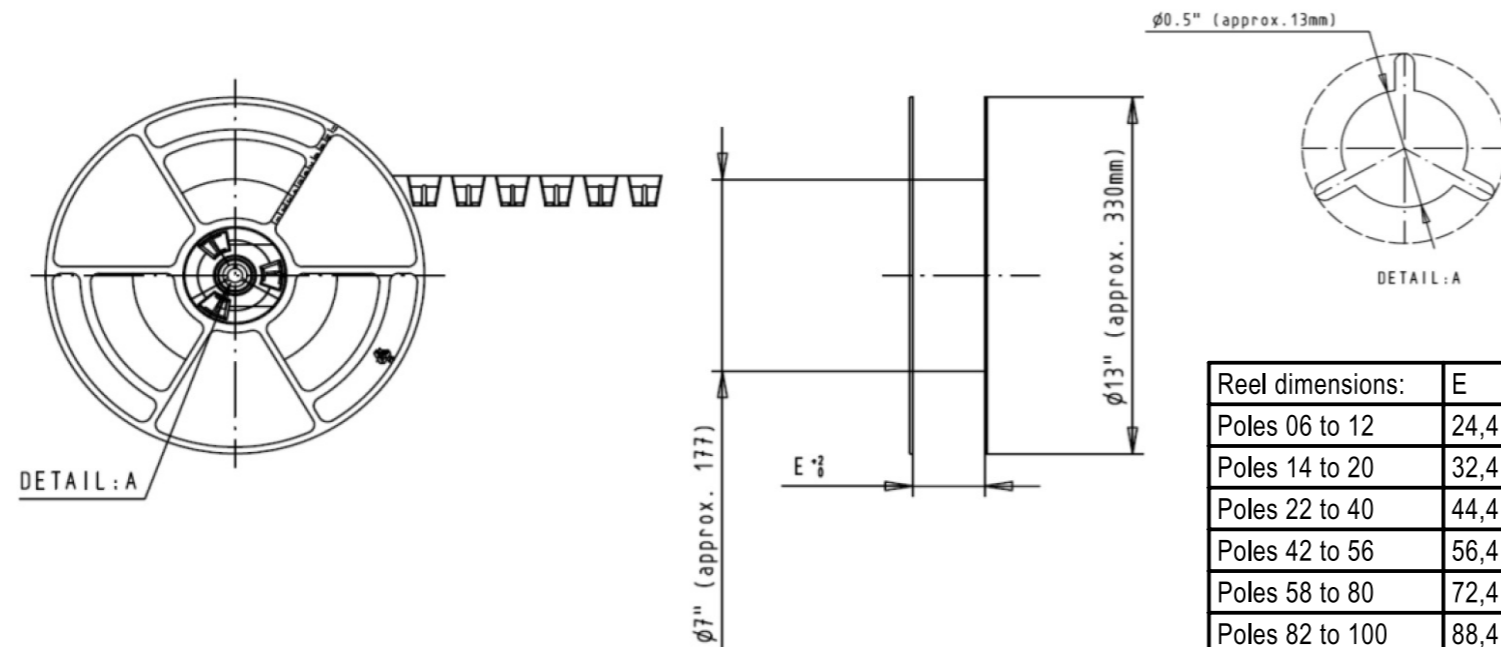

Reel dimensions:	E
Poles 06 to 12	24,4
Poles 14 to 20	32,4
Poles 22 to 40	44,4
Poles 42 to 56	56,4
Poles 58 to 80	72,4
Poles 82 to 100	88,4

APPLICATION INFORMATION

S	14mm				
	13mm				
	12mm				
	11mm				
	10mm				
	9mm				
	8mm				
X & Y	stacking heights	male 1.75mm female 6.25mm	male 3.25mm female 6.25mm	male 1.75mm female 9.05mm	male 3.25mm female 9.05mm
S	PCB distance	8mm - 9.5mm	9.5mm - 11mm	10.8mm - 12.3mm	12.3mm - 13.8mm
	part numbers	15 11 ... 15 21 ...	15 12 ... 15 21 ...	15 11 ... 15 22 ...	15 12 ... 15 22 ...

straight female

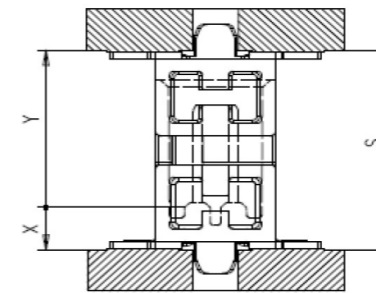

angled female

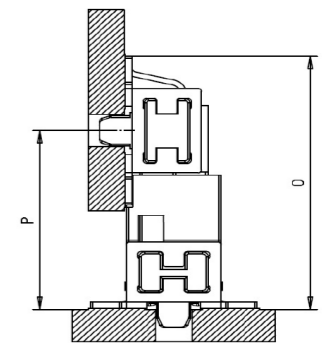

straight male

3,25	9,05	12,3	13,8
1,75	9,05	10,8	12,3
3,25	6,5	9,5	11
1,75	6,25	8	9,5
X	Y	Smin	* Smax

straight male

3,25	10,25	14,08
1,75	8,75	12,58
X	P min.	0

*Smax = Smin + 1.5 wiping length with additional contact overlap security

Admissible inclination

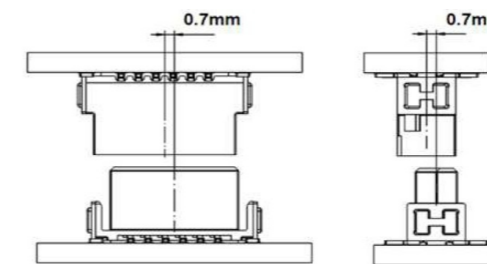

Admissible mismatching

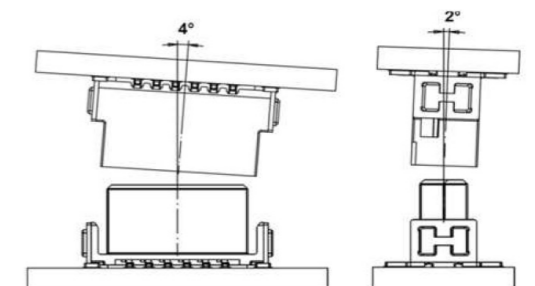

All Dimensions in mm
Original Size DIN A3

Scale
1:1

Free size tol.

Ref.

Sub.



All rights reserved
Department EC PD - CN

Created by
ZHUANGJ

Inspected by
LUOK

Standardisation
HOFFMANN

Date
2018-05-21

State
Final Release

Title
har flex male stacking height 1.75 and 3.25

Doc-Key / ECM-Nr.
100577896/UGD/001/B
500000135280

HARTING Electronics GmbH
D-32339 Espelkamp

Type
DS

Number
15111100301

Rev.
B

Page
2/2

Mouser Electronics

Authorized Distributor

Click to View Pricing, Inventory, Delivery & Lifecycle Information:

HARTING:

<u>15111002601000</u>	<u>15121002601000</u>	<u>15110062601000</u>	<u>15110082601000</u>	<u>15110102601000</u>	<u>15110122601000</u>
<u>15110142601000</u>	<u>15110162601000</u>	<u>15110182601000</u>	<u>15110202601000</u>	<u>15110222601000</u>	<u>15110242601000</u>
<u>15110262601000</u>	<u>15110282601000</u>	<u>15110302601000</u>	<u>15110322601000</u>	<u>15110362601000</u>	<u>15110382601000</u>
<u>15110422601000</u>	<u>15110442601000</u>	<u>15110462601000</u>	<u>15110482601000</u>	<u>15110502601000</u>	<u>15110522601000</u>
<u>15110542601000</u>	<u>15110562601000</u>	<u>15110582601000</u>	<u>15110602601000</u>	<u>15110622601000</u>	<u>15110642601000</u>
<u>15110662601000</u>	<u>15110682601000</u>	<u>15110702601000</u>	<u>15110722601000</u>	<u>15110742601000</u>	<u>15110762601000</u>
<u>15110782601000</u>	<u>15110802601000</u>	<u>15110822601000</u>	<u>15110842601000</u>	<u>15110862601000</u>	<u>15110882601000</u>
<u>15110902601000</u>	<u>15110922601000</u>	<u>15110942601000</u>	<u>15110962601000</u>	<u>15110982601000</u>	<u>15120062601000</u>
<u>15120082601000</u>	<u>15120102601000</u>	<u>15120122601000</u>	<u>15120142601000</u>	<u>15120162601000</u>	<u>15120182601000</u>
<u>15120202601000</u>	<u>15120222601000</u>	<u>15120242601000</u>	<u>15120262601000</u>	<u>15120282601000</u>	<u>15120302601000</u>
<u>15120322601000</u>	<u>15120342601000</u>	<u>15120362601000</u>	<u>15120382601000</u>	<u>15120402601000</u>	<u>15120422601000</u>
<u>15120442601000</u>	<u>15120462601000</u>	<u>15120482601000</u>	<u>15120502601000</u>	<u>15120522601000</u>	<u>15120542601000</u>
<u>15120562601000</u>	<u>15120582601000</u>	<u>15120602601000</u>	<u>15120622601000</u>	<u>15120642601000</u>	<u>15120662601000</u>
<u>15120682601000</u>	<u>15120702601000</u>	<u>15120722601000</u>	<u>15120742601000</u>	<u>15120762601000</u>	<u>15120782601000</u>
<u>15120802601000</u>	<u>15120822601000</u>	<u>15120842601000</u>	<u>15120862601000</u>	<u>15120882601000</u>	<u>15120902601000</u>
<u>15120922601000</u>	<u>15120942601000</u>	<u>15120962601000</u>	<u>15120982601000</u>	<u>15120162601333</u>	

Данный компонент на территории Российской Федерации

Вы можете приобрести в компании MosChip.

Для оперативного оформления запроса Вам необходимо перейти по данной ссылке:

<http://moschip.ru/get-element>

Вы можете разместить у нас заказ для любого Вашего проекта, будь то серийное производство или разработка единичного прибора.

В нашем ассортименте представлены ведущие мировые производители активных и пассивных электронных компонентов.

Нашей специализацией является поставка электронной компонентной базы двойного назначения, продукции таких производителей как XILINX, Intel (ex.ALTERA), Vicor, Microchip, Texas Instruments, Analog Devices, Mini-Circuits, Amphenol, Glenair.

Сотрудничество с глобальными дистрибьюторами электронных компонентов, предоставляет возможность заказывать и получать с международных складов практически любой перечень компонентов в оптимальные для Вас сроки.

На всех этапах разработки и производства наши партнеры могут получить квалифицированную поддержку опытных инженеров.

Система менеджмента качества компании отвечает требованиям в соответствии с ГОСТ Р ИСО 9001, ГОСТ РВ 0015-002 и ЭС РД 009

Офис по работе с юридическими лицами:

105318, г.Москва, ул.Щербаковская д.3, офис 1107, 1118, ДЦ «Щербаковский»

Телефон: +7 495 668-12-70 (многоканальный)

Факс: +7 495 668-12-70 (доб.304)

E-mail: info@moschip.ru

Skype отдела продаж:

moschip.ru

moschip.ru_4

moschip.ru_6

moschip.ru_9