

General Description

The TQP7M9101 is a high-linearity driver amplifier in a standard SOT-89 surface mount package. This InGaP/GaAs HBT delivers high performance across a broad range of frequencies with +40 dBm OIP3 and with +25 dBm P1dB while only consuming 87 mA quiescent current. All devices are 100% RF and DC tested.

The TQP7M9101 incorporates on-chip features that differentiate it from other products in the market. The RF output is internally matched in to 50 ohms. Only input matching is required for optimal performance in specific frequency bands making the component easy for design engineers to implement in their systems. The amplifier integrates an on-chip DC over-voltage and RF over-drive protection. This protects the amplifier from electrical DC voltage surges and high input RF input power levels that may occur in a system. On-chip ESD protection allows the amplifier to have a very robust Class 2 HBM ESD rating.

The TQP7M9101 is targeted for use as a driver amplifier in wireless infrastructure where high linearity, medium power, and high efficiency are required. The device an excellent candidate for transceiver line cards in current and next generation multi-carrier 3G / 4G base stations.

Functional Block Diagram

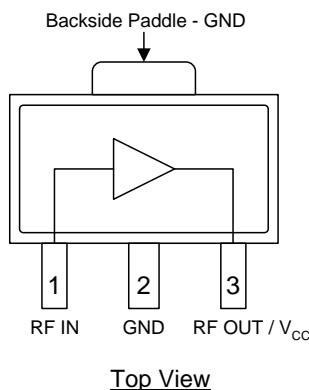

3 Pin SOT-89 Package

Product Features

- 400 – 5000 MHz
- +25 dBm P1dB
- +39.5 dBm Output IP3
- 17.5 dB Gain at 2140 MHz
- +5 V Single Supply, 87 mA Current
- No Output Matching Required
- Internal RF Overdrive Protection
- Internal DC Overvoltage Protection
- On-Chip ESD Protection
- SOT-89 Package

Applications

- Repeaters
- Mobile Infrastructure
- CDMA / WCDMA / LTE
- General Purpose Wireless

Ordering Information

Part No.	Description
TQP7M9101	1/4 W High Linearity Amplifier
TQP7M9101-PCB900	869 – 960 MHz Evaluation Board
TQP7M9101-PCB2140	2.11 – 2.17 GHz Evaluation Board
TQP7M9101-PCB2600	2.5 – 2.7 GHz Evaluation Board

Standard T/R size = 1000 pieces on a 7" reel

Absolute Maximum Ratings

Parameter	Rating
Storage Temperature	-65 to 150 °C
RF Input Power, CW, 50Ω, T=25°C	+23 dBm
Device Voltage (V _{CC})	+8 V

Exceeding any one or a combination of the Absolute Maximum Rating conditions may cause permanent damage to the device. Extended application of Absolute Maximum Rating conditions to the device may reduce device reliability.

Recommended Operating Conditions

Parameter	Min	Typ	Max	Units
Device Voltage (V _{CC})	+3	+5	+5.25	V
T _{CASE}	-40		+105	°C
T _j for >10 ⁶ hours MTTF			+170	°C

Electrical specifications are measured at specified test conditions. Specifications are not guaranteed over all recommended operating conditions.

Electrical Specifications

Parameter	Conditions ⁽¹⁾	Min	Typ	Max	Units
Operational Frequency Range		400		5000	MHz
Test Frequency			2140		MHz
Gain		15.6	17.5	18.6	dB
Input Return Loss			15		dB
Output Return Loss			13.5		dB
Output P1dB		+23.5	+25		dBm
Output IP3	P _{out} = +8 dBm/tone, Δf = 1 MHz	+36.5	+39.5		dBm
WCDMA Channel Power	-50 dBc ACLR, Note 2		+14.5		dBm
Noise Figure			3.9		dB
Quiescent Current, I _{CC}		70	87	105	mA
Thermal Resistance, θ _{JC}	Junction to case			71	°C/W

Notes:

1. Test conditions unless otherwise noted: V_{CC} = +5 V, Temp. = +25 °C, matched 2140 MHz reference circuit
2. ACLR test set-up: 3GPP WCDMA, TM1+64 DPCH, +5 MHz offset, PAR = 10.2 dB at 0.01% Probability

Performance Summary Table

Frequency	635	700	800	960	1500	1805	1900	2100	2140	2600	3500	MHz
Gain	20	18.5	18.7	20.1	19.4	18.0	16.6	15.9	17.5	16.5	15.0	dB
Input Return Loss	12	11.8	17.7	14	19	10.7	12	12	15	10	17	dB
Output Return Loss	33	12.8	19.1	17	13	15.8	11	9.5	13.5	14	11	dB
Output P1dB	+25.0	+24.1	+24.2	+24.4	+23.8	+25.0	+24.0	+24.2	+24.8	+24.9	+23.4	dBm
Output IP3	+40.0	+39.6	+40.4	+38.2	+42.8	+39.7	+47.8	+43.8	+39.5	+40.6	+39.4	dBm

Notes:

1. Test conditions unless otherwise noted: V_{CC} = +5 V, Temp. = +25 °C, matched reference circuit
2. Reference designs for the various frequencies are either included on this datasheet or may be obtained by contacting appsupport@qorvo.com

Device Characterization Data

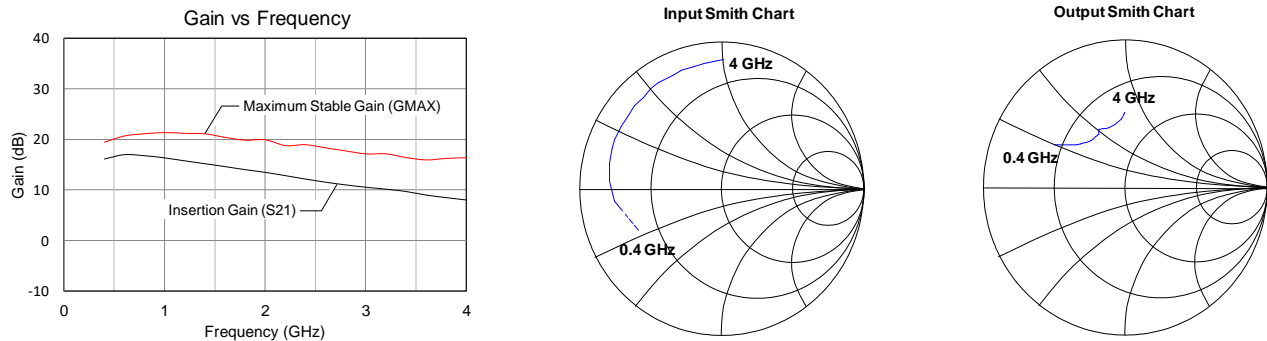

Note: The gain for the unmatched device in a 50 ohm system is shown as the black trace labeled "Gain (S21)". In a circuit tuned for a particular frequency, it is expected that actual gain will be higher, up to the maximum stable gain. The maximum stable gain is shown as the red trace [Gmax]. The impedance Smith chart plots are shown from 0.05 to 4 GHz.

S-Parameters

Freq (MHz)	S11 (dB)	S11 (ang)	S21 (dB)	S21 (ang)	S12 (dB)	S12 (ang)	S22 (dB)	S22 (ang)
400	-3.74	-154.94	16.08	172.65	-30.84	32.65	-4.47	155.03
600	-2.43	-174.00	16.93	152.42	-28.85	13.25	-6.02	149.89
800	-2.00	175.84	16.72	137.72	-28.64	3.42	-6.63	147.55
1000	-1.81	167.43	16.29	123.90	-28.38	-4.74	-7.05	144.48
1200	-1.71	160.50	15.71	112.48	-28.45	-10.23	-7.29	142.81
1400	-1.68	155.82	15.15	102.29	-28.29	-15.72	-7.67	139.67
1600	-1.66	149.16	14.58	91.96	-28.34	-19.66	-7.92	136.04
1800	-1.65	143.36	13.98	82.32	-28.40	-25.64	-8.05	132.86
2000	-1.56	137.28	13.45	72.43	-28.25	-30.76	-8.05	129.68
2200	-1.60	131.41	12.80	64.37	-28.52	-35.06	-7.96	125.67
2400	-1.43	126.29	12.14	56.45	-28.43	-39.47	-7.47	122.90
2600	-1.41	122.01	11.52	48.81	-28.73	-42.87	-7.49	122.21
2800	-1.43	117.57	10.99	41.39	-28.68	-47.17	-7.71	119.34
3000	-1.45	114.12	10.53	34.73	-28.78	-49.96	-7.92	116.57
3200	-1.36	109.38	10.15	27.42	-28.85	-52.90	-7.87	114.37
3400	-1.40	103.72	9.69	19.90	-29.00	-59.40	-7.85	106.77
3600	-1.32	98.51	8.99	12.40	-29.04	-63.10	-7.32	100.14
3800	-1.19	93.06	8.49	5.24	-29.04	-68.03	-6.75	96.77
4000	-1.11	89.37	8.02	-0.57	-29.02	-70.86	-6.53	95.94

Test Conditions: $V_{CC} = +5\text{ V}$, $I_{CC} = 87\text{ mA}$, Temp. = $+25\text{ }^\circ\text{C}$, unmatched 50 Ohm system, reference plane at device leads

617 – 652 MHz Reference Design

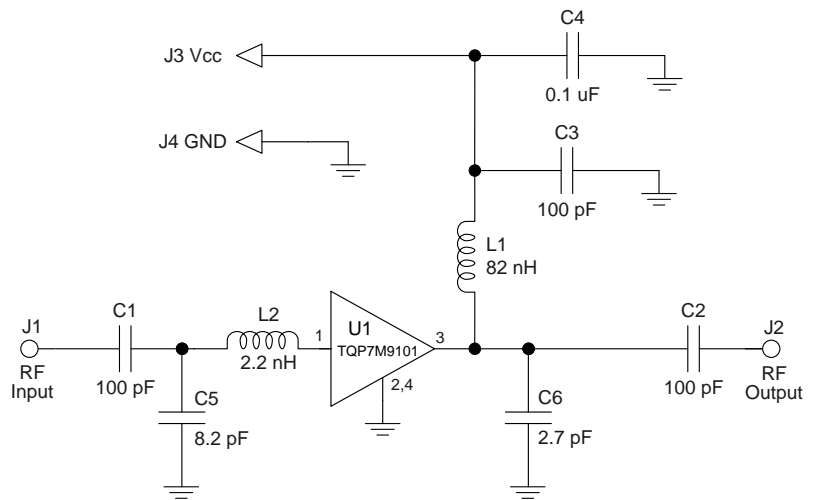
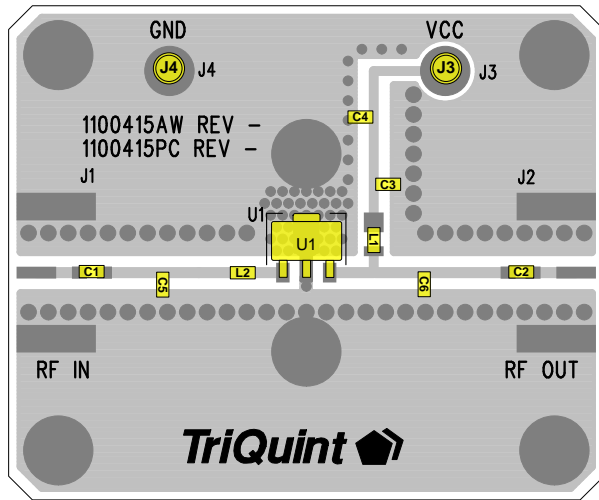

Notes:

1. See Evaluation Board PCB Information section for PCB material and stack-up
2. All components are 0603 size unless otherwise specified.
3. Critical component placement locations:
 Distance from U1 Pin 1 (left edge) to L2 (right edge): 90 mils
 Distance from U1 Pin 1 (left edge) to C5 (right edge): 310 mils
 Distance from U1 Pin 3 (right edge) to C6 (left edge): 245 mils

Bill of Material 617 – 652 MHz Reference Design

Reference Des.	Value	Description	Manuf.	Part Number
n/a	n/a	Printed Circuit Board	Qorvo	1100415
U1	n/a	Amplifier, SOT-89 pkg.	Qorvo	TQP7M9101
L1	82 nH	Inductor, 0805, 5%, Coilcraft CS Series	Coilcraft	0805CS-820XJLB
L2	2.2 nH	Inductor, Chip, 0603	various	
C1, C2, C3	100 pF	Cap., Chip, 5%, 50 V, NPO/COG	various	
C4	0.1 uF	Cap., Chip, 10%, 50 V, X7R	various	
C5	8.2 pF	Cap., Chip, +/-0.1 pF. 50 V NPO/COG	various	
C6	2.7 pF	Cap., Chip, +/-0.1 pF. 50 V NPO/COG	various	
J3, J4	n/a	Solder Turret	various	

Typical Performance 617 – 652 MHz Reference Design

Parameter		Typical Value				
		617	635	652	MHz	
Frequency (MHz)		617	635	652	MHz	
Gain		20	20	20	dB	
Input Return Loss		10	12	14	dB	
Output Return Loss		22	33	31	dB	
Output P1dB		+24.8	+25.0	+24.9	dBm	
Output IP3	P _{out} =+8 dBm/tone, Δf = 1 MHz	+40.7	+40.0	+39.5	dBm	
LTE Chan. Power ⁽²⁾	-50 dBc ACLR	+14.0	+14.4	+14.8	dBm	

Notes:

1. Test conditions unless otherwise noted: VCC = +5 V, ICQ = 87 mA (typ.), Temp. = +25 °C
2. ACLR test set-up: 1 CH, 20 MHz BW, LTE E-TM1.1, 9.5 dB PAR at 0.01% Probability

Performance Plots 617 – 652 MHz Reference Design

Test conditions unless otherwise noted: $V_{CC} = +5\text{ V}$, $I_{CQ} = 87\text{ mA}$ (typ.), $Temp. = +25\text{ }^{\circ}\text{C}$

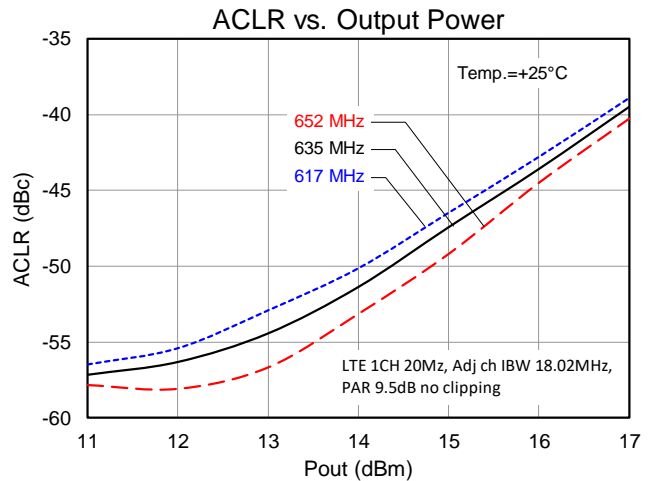
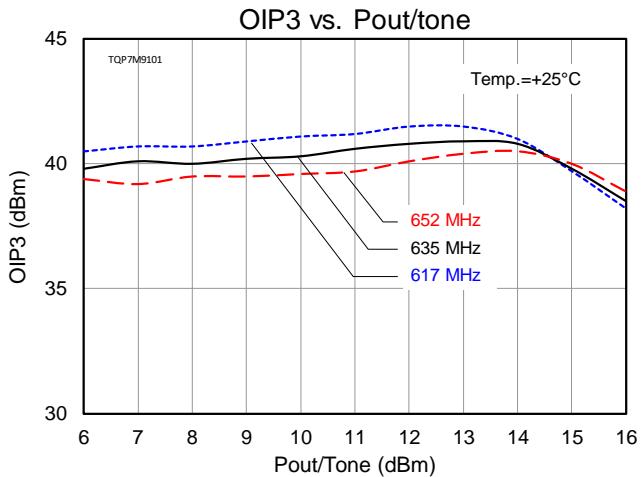
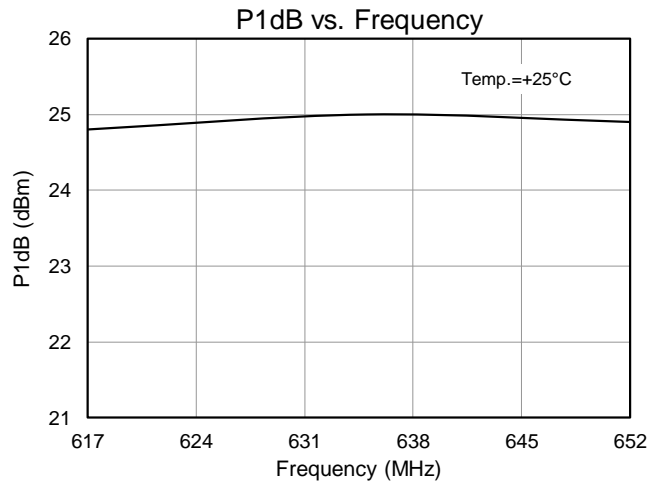
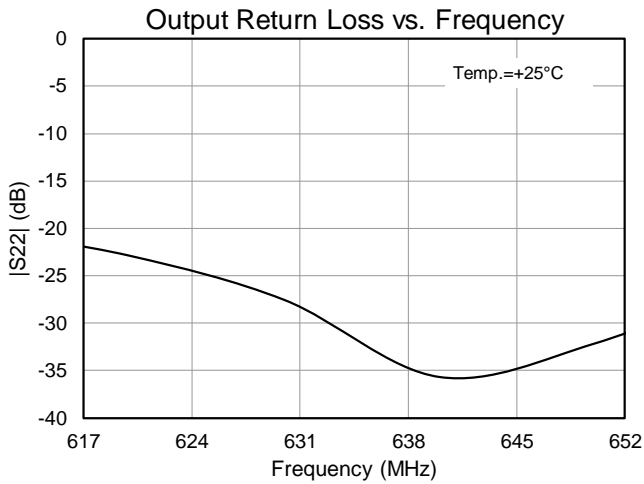
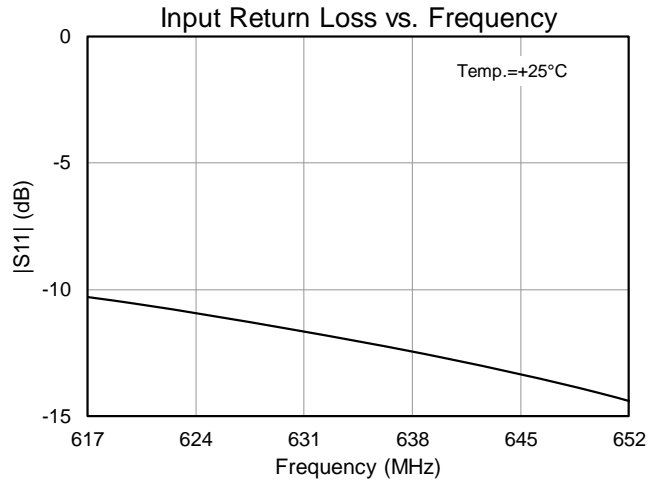
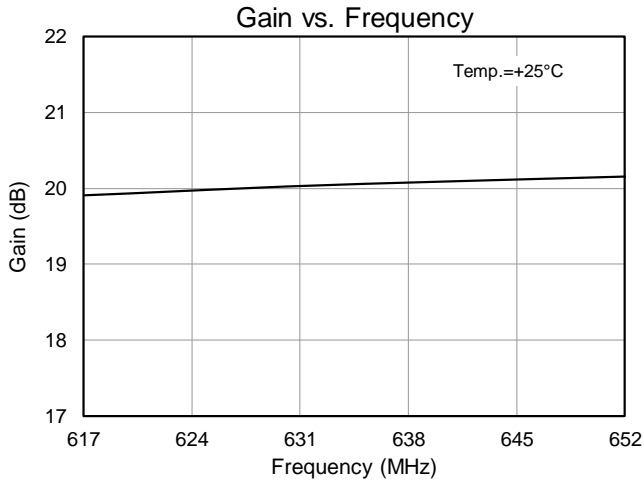

700 – 1000 MHz Reference Design

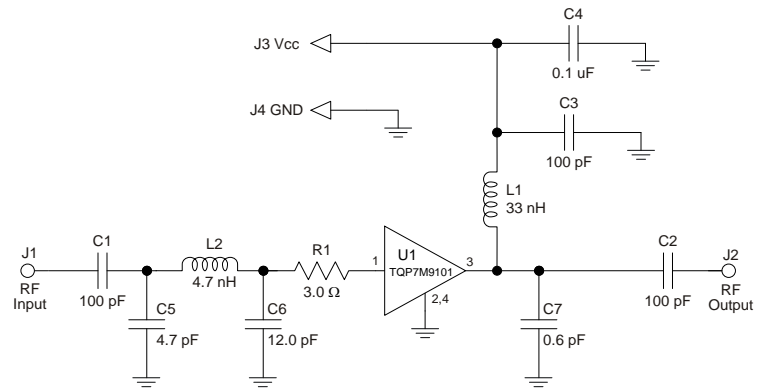
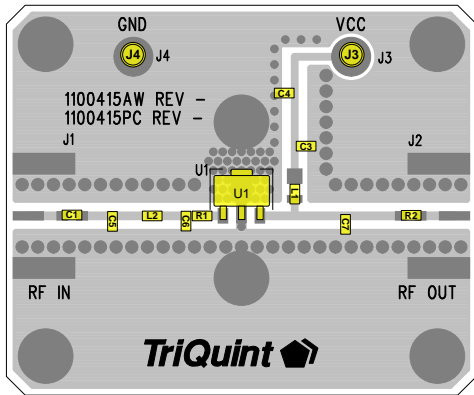

- Notes:
1. See Evaluation Board PCB Information section for PCB material and stack-up
 2. All components are 0603 size unless otherwise specified.
 3. Critical component placement locations:
 - Distance from U1 Pin 1 Pad (left edge) to R1 (right edge): 10 mils (0.5° at 900 MHz)
 - Distance from R1 (left edge) to C6 (right edge): 5 mils (0.2° at 900 MHz)
 - Distance from C6 (left edge) to L2 (right edge): 60 mils (2.8° at 900 MHz)
 - Distance from L2 (left edge) to C5 (right edge): 60 mils (2.8° at 900 MHz)
 - Distance from U1 Pin 3 Pad (right edge) to C7 (left edge): 250 mils (11.7° at 900 MHz)

Bill of Material 700 – 1000 MHz Reference Design

Reference Des.	Value	Description	Manuf.	Part Number
n/a	n/a	Printed Circuit Board	Qorvo	1100415
U1	n/a	Amplifier, SOT-89 pkg.	Qorvo	TQP7M9101
L1	33 nH	Inductor, 0805, 5%, Coilcraft CS Series	Coilcraft	0805CS-330XJLB
L2	4.7 nH	Inductor, Chip, 0603	various	
C1, C2, C3	100 pF	Cap., Chip, 5%, 50 V, NPO/COG	various	
C4	0.1 uF	Cap., Chip, 10%, 50 V, X7R	various	
C5	4.7 pF	Cap., Chip, +/-0.1 pF. 50 V NPO/COG	various	
C6	12 pF	Cap., Chip, 2% 50 V NPO/COG	various	
C7	0.6 pF	Cap., Chip, +/-0.05 pF. 50 V NPO/COG	various	
J3, J4	n/a	Solder Turret	various	

Typical Performance 700 – 1000 MHz Reference Design

Parameter	Typical Value							
	700	800	850	900	960	MHz		
Frequency (MHz)								
Gain	18.5	18.7	18.6	18.5	18.2		dB	
Input Return Loss	11.8	17.7	18.2	16.2	13.1		dB	
Output Return Loss	12.8	19.1	22.9	32.7	23.7		dB	
Output P1dB	+24.1	+24.2	+24.4	+24.4	+24.6		dBm	
Output IP3	Pout=+8 dBm/tone, Δf = 1 MHz		+39.6	+40.4	+41.2	+39.7	+39.8	dBm
WCDMA Chan. Power ⁽¹⁾	-55 dBc ACLR		+12.8	+13.2	+13.5	+14.0	+14.0	dBm
Noise Figure	5.0	5.0	5.1	5.2	5.9		dB	

- Notes:
1. Test conditions unless otherwise noted: VCC = +5 V, ICQ = 87 mA (typ.), Temp. = +25 °C
 2. ACLR test set-up: 3GPP WCDMA, TM1+64 DPCH, +5 MHz offset, PAR = 10.2 dB at 0.01% Probability

Performance Plots 700 – 1000 MHz Reference Design

Test conditions unless otherwise noted: $V_{CC} = +5\text{ V}$, $I_{CQ} = 87\text{ mA}$ (typ.), $Temp. = +25\text{ }^{\circ}\text{C}$

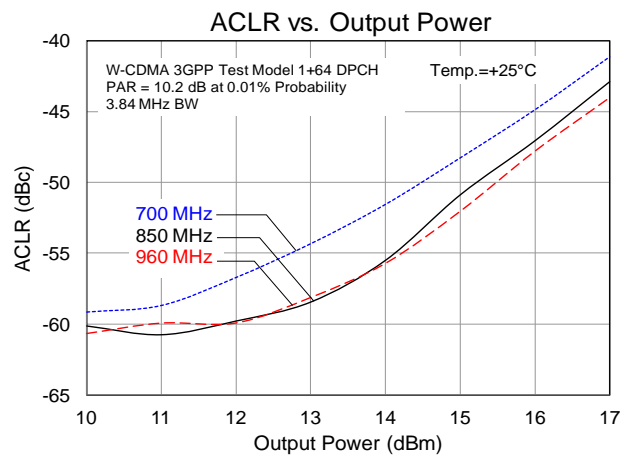
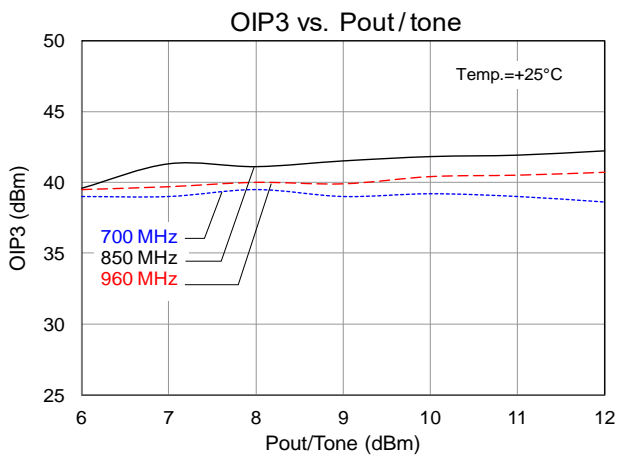
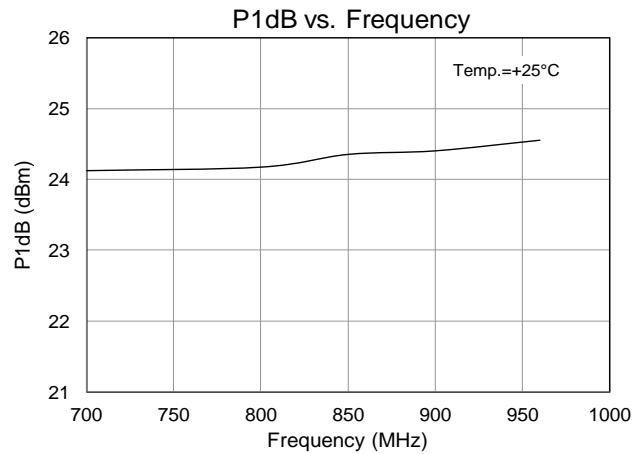
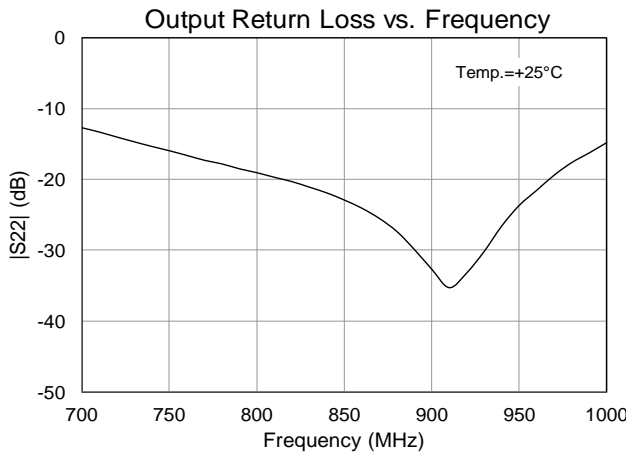
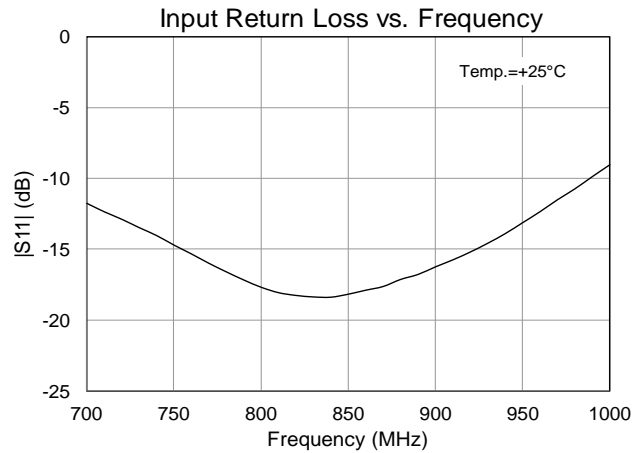
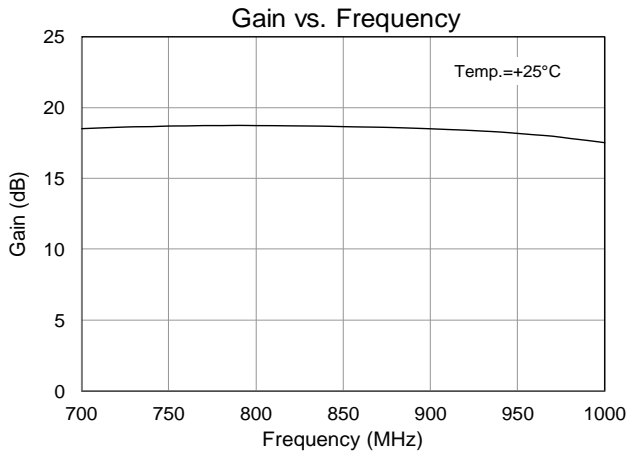

869 – 960 MHz Evaluation Board (TQP7M9101– PCB900)

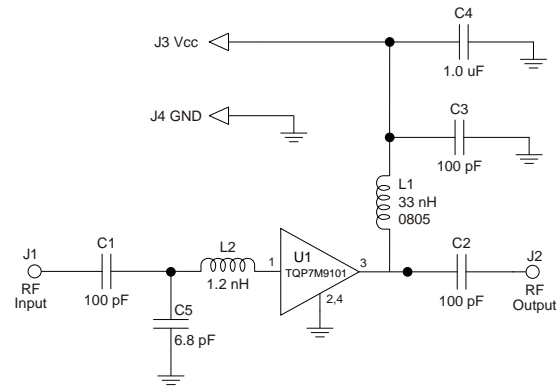
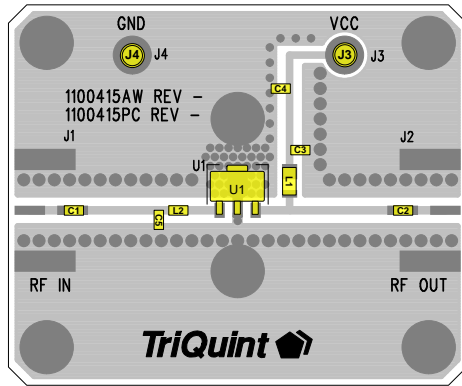

Notes:

1. See Evaluation Board PCB Information section for PCB material and stack-up
2. Components (C1 and C2) are blocking capacitors and their locations are not critical to the matching network.
3. All components are of 0603 size unless otherwise specified.
4. Critical component placement locations:
 Distance from U1 Pin 1 Pad (left edge) to L2 (right edge): 90 mils (4.8° at 920 MHz)
 Distance from L2 (left edge) to C5 (right edge): 40 mils (2.1° at 920 MHz)

Bill of Material TQP7M9101– PCB900

Reference Des.	Value	Description	Manuf.	Part Number
n/a	n/a	Printed Circuit Board	Qorvo	1100415
U1	n/a	Amplifier, SOT-89 pkg.	Qorvo	TQP7M9101
L1	33 nH	Inductor, 0805, 5%, Coilcraft CS Series	Coilcraft	0805CS-330XJLB
L2	1.2 nH	Inductor, Chip, 0603	various	
C1, C2, C3	100 pF	Cap., Chip, 5%, 50V, NPO/COG	various	
C4	1.0 uF	Cap., Chip, 10%, 10V, X5R	various	
C5	6.8 pF	Cap., Chip, +/-0.1pF. 50V NPO/COG	various	
J1, J2	n/a	RF SMA Connector	Johnson Comp.	142-0701-851
J3, J4	n/a	Solder Turret	various	

Typical Performance TQP7M9101– PCB900

Parameter	Conditions	Typical Value			Units
Frequency		869	920	960	MHz
Gain		20.2	20.4	20.1	dB
Input Return Loss		12	17	14	dB
Output Return Loss		18	23	17	dB
Output P1dB		+24.3	+24.4	+24.4	dBm
OIP3	Pout= +8 dBm/tone, Δf=1 MHz	+39.2	+38.6	+38.2	dBm
WCDMA Channel Power ⁽¹⁾	-55 dBc ACLR	+12.7	+13.4	+13.5	dBm
Noise Figure		4.0	4.0	3.9	dB

Notes:

1. Test conditions unless otherwise noted: V_{CC} = +5 V, I_{CO} = 87 mA (typ.), Temp. = +25 °C
2. ACLR Test set-up: 3GPP WCDMA, TM1+64 DPCH, +5 MHz offset, PAR = 10.2 dB at 0.01% Probability

Performance Plots TQP7M9101-PCB900

Test conditions unless otherwise noted: $V_{CC} = +5\text{ V}$, $I_{CQ} = 87\text{ mA}$ (typ.), Temp. = $+25\text{ }^{\circ}\text{C}$

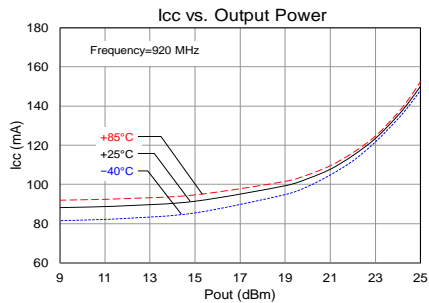
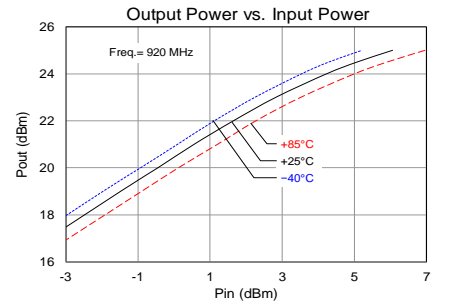
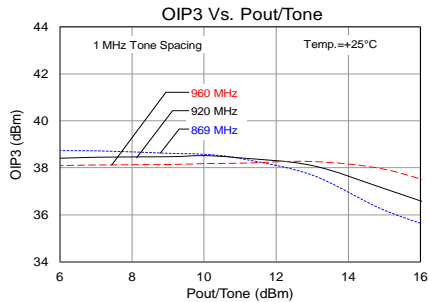
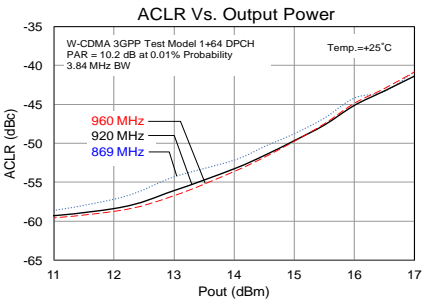
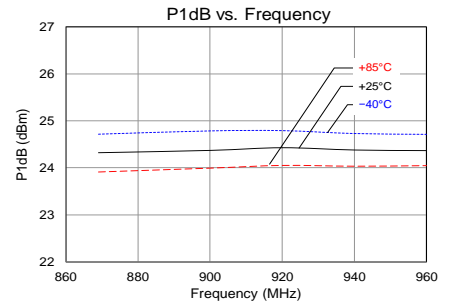
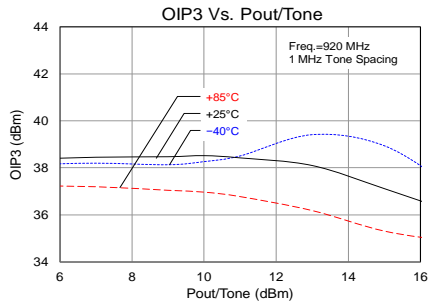
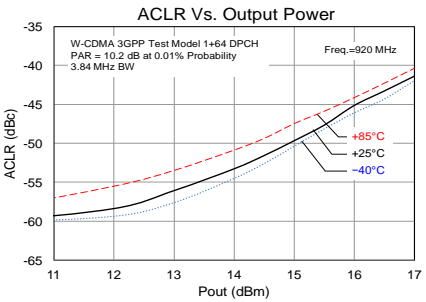
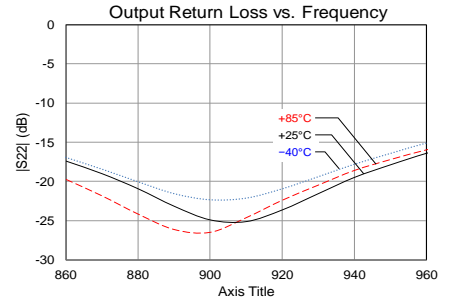
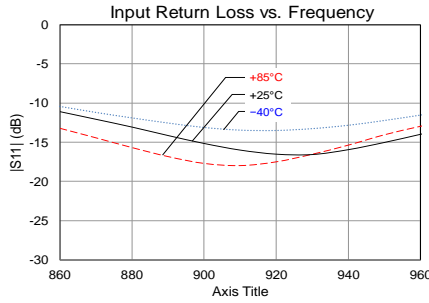
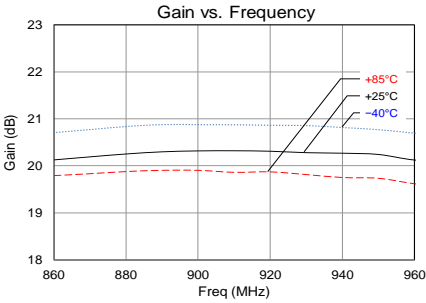

1460 – 1540 MHz Reference Design

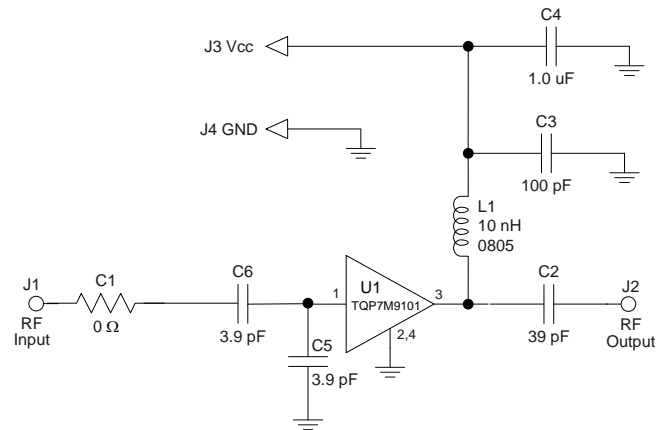
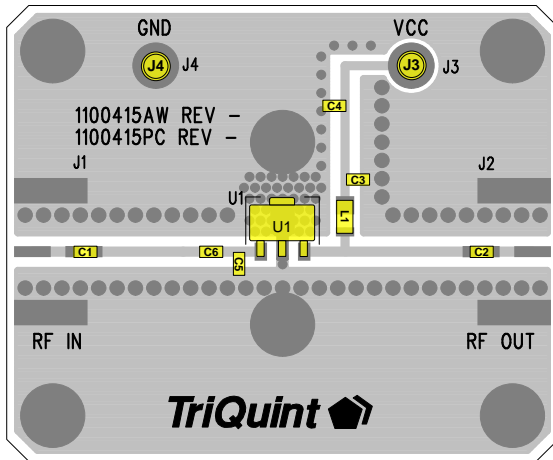

Notes:

1. See Evaluation Board PCB Information for material and stack up.
2. 0 Ω resistor (C1) may be replaced with copper trace in the target application layout.
3. All components are of 0603 size unless stated on the schematic.
4. Critical component placement locations:
 Distance between U1 Pin 1 Pad (left edge) to C5 (right edge): 60 mils
 Distance between U1 Pin 1 Pad (left edge) to C6 (right edge): 90 mils

Bill of Material 1460 – 1540 MHz Reference Design

Reference Des.	Value	Description	Manuf.	Part Number
n/a	n/a	Printed Circuit Board	Qorvo	1100415
U1	n/a	0.25 W High Linearity Amplifier	Qorvo	TQP7M9101
C5 , C6	3.9 pF	CAP, 0603, +/-0.1pF. 200V. NPO/COG	various	
C1	0 Ω	RES, 0603, +/-5%, 1/16 W	various	
C2	39 pF	CAP, 0603, +/-5%, 50V NPO/COG	various	
C3	100 pF	Cap., Chip, 0603, +/-5%. 50V NPO/COG	various	
C4	1.0 uF	CAP, 0603, 10%, X5R , 10V	various	
L1	10 nH	Inductor, 0805, 5%, Coilcraft CS Series	Coilcraft	0805CS-100XJLB
J3, J4	n/a	Solder Turret	various	

Typical Performance 1460 – 1540 MHz Reference Design

Parameter	Conditions	Typical Value			Units
		1460	1500	1540	
Frequency		1460	1500	1540	MHz
Gain		19.4	19.4	19.3	dB
Input Return Loss		14	19	20	dB
Output Return Loss		17	13	10	dB
Output P1dB		+24.4	+23.8	+23.7	dBm
OIP3	Pout= +8 dBm/tone, $\Delta f=1$ MHz	+44	+42.8	+42	dBm
Noise Figure		4.6	4.7	4.8	dBm

Notes:

1. Test conditions unless otherwise noted: $V_{CC} = +5$ V, $I_{CQ} = 87$ mA (typ.), Temp. = +25 $^{\circ}$ C

Performance Plots 1460 – 1540 MHz Reference Design

Test conditions unless otherwise noted: VCC = +5 V, ICQ = 87 mA (typ.), Temp. = +25 °C

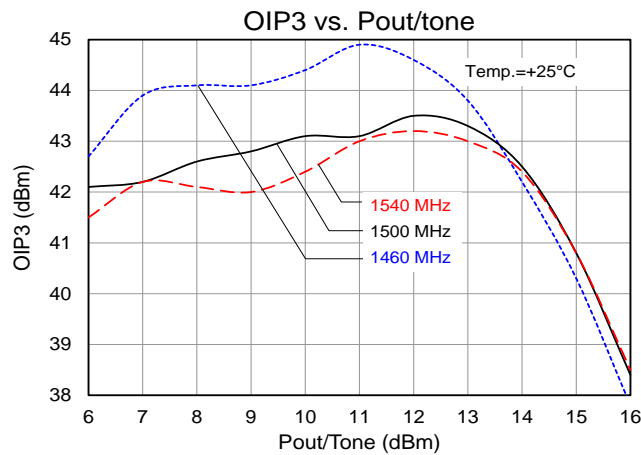
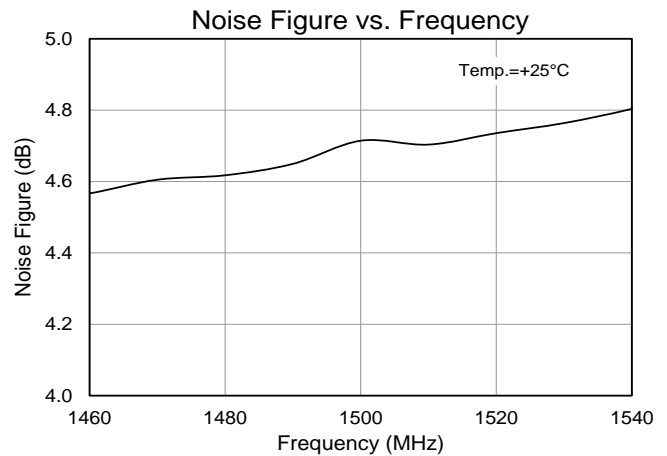
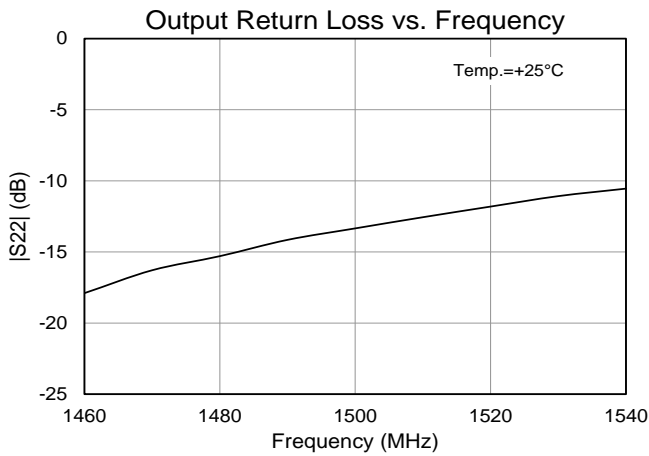
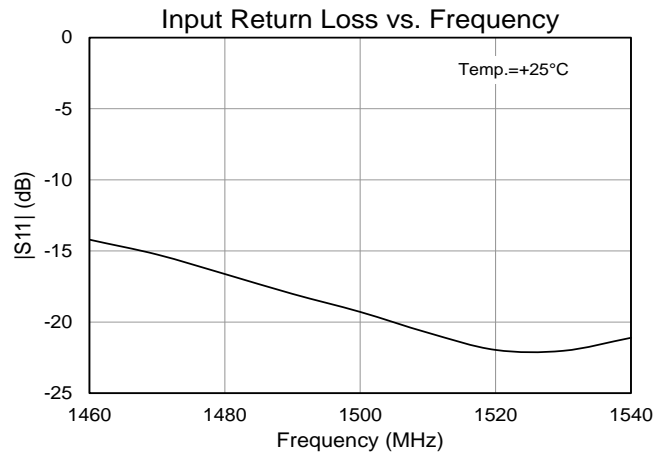
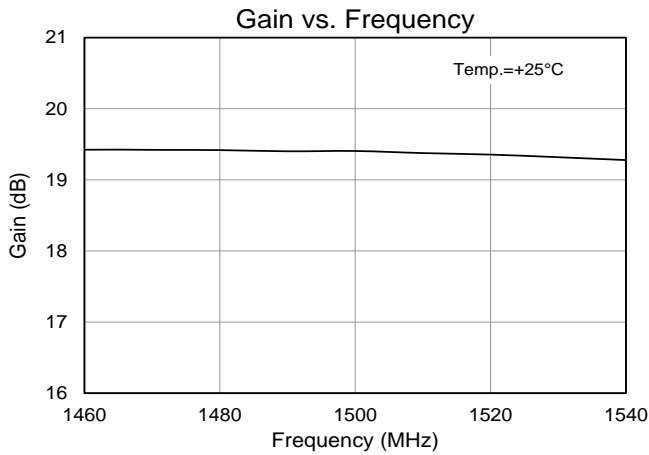

1805 – 1990 MHz Reference Design

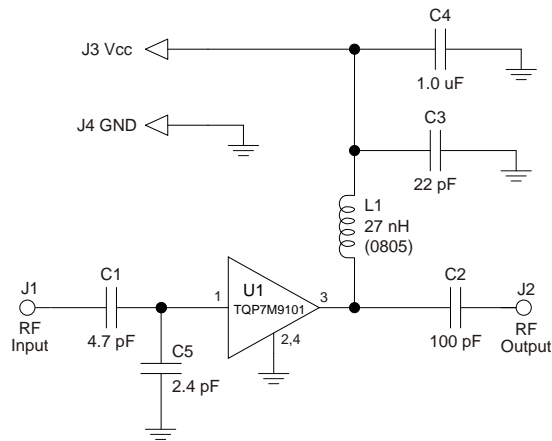
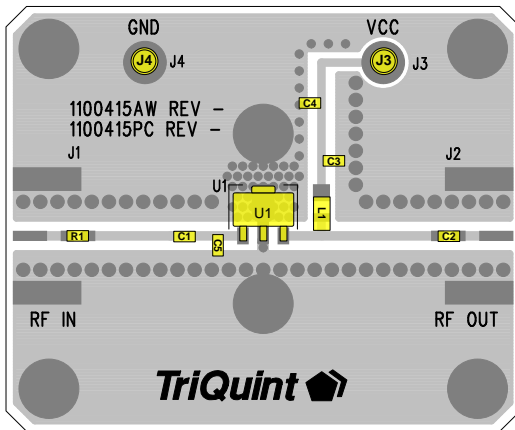

Notes:

1. See Evaluation Board PCB Information section for PCB material and stack-up.
2. Component R1 on the PCB is a (0 Ω) Resistor and may be replaced by a copper trace
3. All components are of 0603 size unless otherwise specified.
4. Critical component placement:
 Distance from U1 Pin 1 Pad (left edge) to C5 (right edge): 30 mils (3.0° at 1900 MHz)
 Distance from C5 (left edge) to C1 (right edge): 55 mils (5.5° at 1900 MHz)

Bill of Material 1805 – 1990 MHz Reference Design

Reference Des.	Value	Description	Manuf.	Part Number
n/a	n/a	Printed Circuit Board	Qorvo	1100415
U1	n/a	0.25 W High Linearity Amplifier	Qorvo	TQP7M9101
R1	0 Ω	RES, 0603, 5PCT. 1/16W. CHIP	various	
C1	4.7 pF	CAP, Chip, +/-0.1pF. 50V NPO/COG	various	
C5	2.4 pF	CAP, Chip, +/-0.1pF. 50V NPO/COG	various	
C2	100 pF	CAP, 0603, 5%, 50V, NPO/COG	various	
C3	22 pF	CAP, 0603, 5%, 50V, NPO/COG	various	
C4	1.0 uF	CAP, 0603, 10%, X5R , 10V	various	
L1	27 nH	Inductor, 0805, 5%, Coilcraft CS series	Coilcraft	0805CS-270XJLB
J3, J4	n/a	Solder Turret	various	

Typical Performance 1805 – 1990 MHz Reference Design

Parameter	Conditions ⁽¹⁾	Typical Value						Units
		1805	1850	1880	1930	1960	1990	
Frequency (MHz)		1805	1850	1880	1930	1960	1990	MHz
Gain		18.0	17.9	17.9	17.7	17.7	17.6	dB
Input Return Loss		10.7	11.5	11.9	12.4	12.4	12.2	dB
Output Return Loss		15.8	14.9	14.2	13.4	13.1	12.8	dB
Output P1dB		+25.0	+25.1	+25.1	+25.1	+25.1	+25.1	dBm
Output IP3	+8 dBm/tone, Δf = 1 MHz	+39.7	+39.6	+39.5	+39.2	+38.7	+39.1	dBm
WCDMA Channel Power	-55 dBc ACLR, Note 2	+14.5	+14.5	+14.4	+14.3	+14.0	+14.1	dBm

Notes:

1. Test conditions unless otherwise noted: V_{CC} = +5 V, I_{CO} = 87 mA (typ.), Temp. = +25 °C
2. ACLR Test set-up: 3GPP WCDMA, TM1+64 DPCH, +5 MHz offset, PAR = 10.2 dB at 0.01% Probability

Performance Plots 1805 – 1990 MHz

Test conditions unless otherwise noted: $V_{CC} = +5\text{ V}$, $I_{CQ} = 87\text{ mA}$ (typ.), Temp. = $+25\text{ }^{\circ}\text{C}$

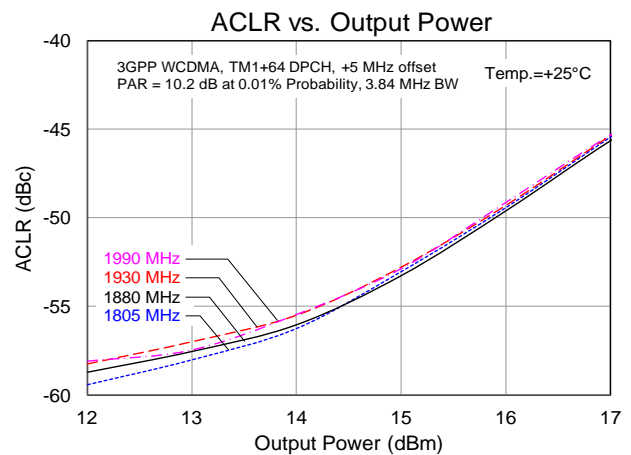
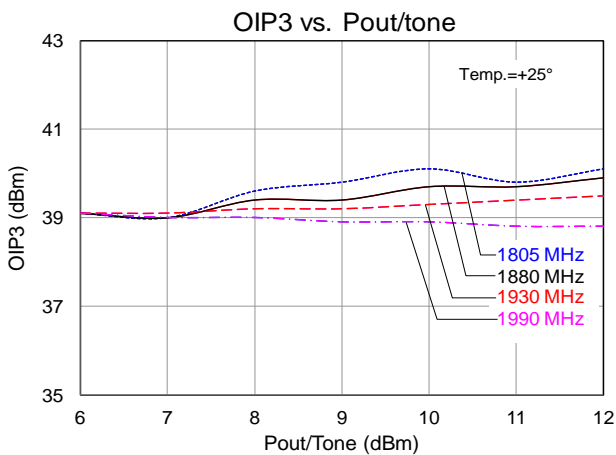
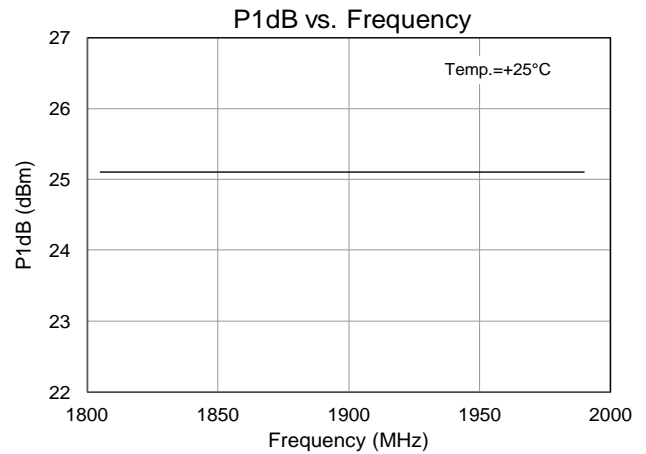
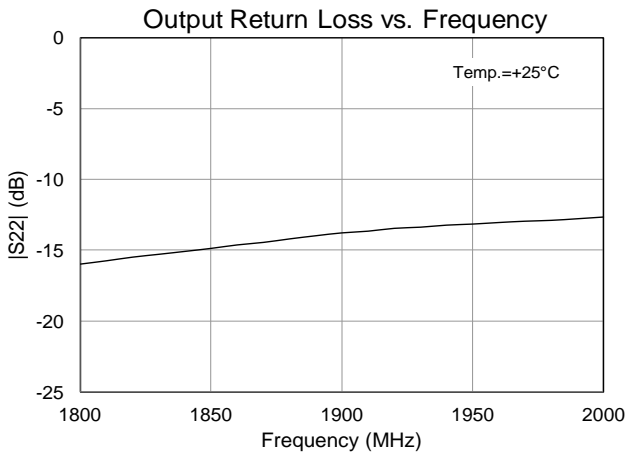
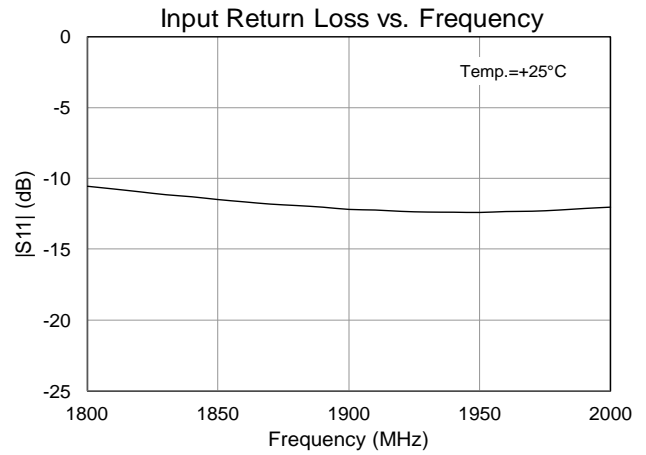
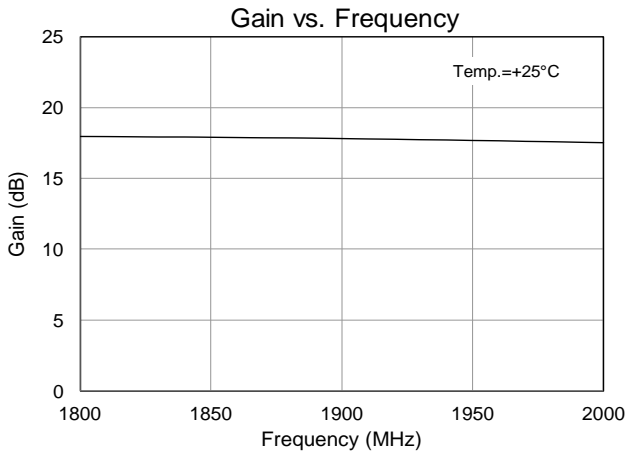

2110 – 2170 MHz Evaluation Board (TQP7M9101-PCB2140)

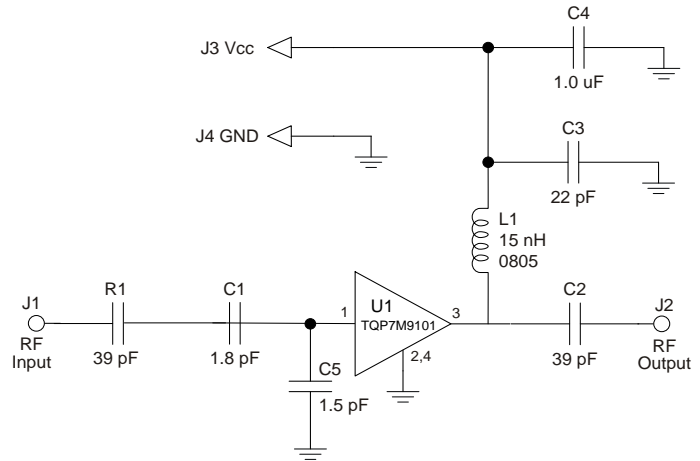
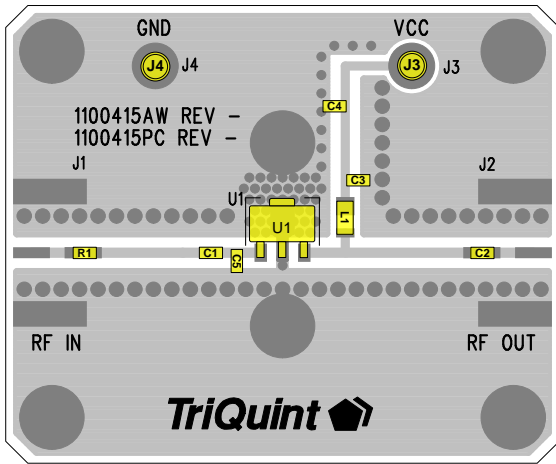

Notes:

1. See Evaluation Board PCB Information section for PCB material and stack-up.
2. Component (R1) is a 39 pF capacitor and may be replaced with copper trace in the target application layout.
3. All components are of 0603 size unless otherwise specified.
4. Critical component placement locations:
 - Distance from U1 Pin 1 Pad (left edge) to C5 (right edge): 40 mils (4.5° at 2140 MHz)
 - Distance from U1 Pin 1 Pad (left edge) to C1 (right edge): 90 mils (10.0° at 2140 MHz)

Bill of Material TQP7M9101-PCB2140

Reference Des.	Value	Description	Manuf.	Part Number
n/a	n/a	Printed Circuit Board	Qorvo	1100415
U1	n/a	Amplifier, SOT-89 pkg.	Qorvo	TQP7M9101
L1	15 nH	Inductor, 0805, 5%, Coilcraft CS Series	Coilcraft	0805CS-150XJLB
C1	1.8 pF	Cap., Chip, 0603, +/-0.1pF. 200V. NPO/COG	various	
C5	1.5 pF	Cap., Chip, 0603, +/-0.1pF. 200V. NPO/COG	various	
R1, C2	39 pF	Cap., Chip, 5%, 50V, NPO/COG	various	
C3	22 pF	Cap., Chip, 5%, 50V, NPO/COG	various	
C4	1.0 μF	Cap., Chip, 10%, 10V, X5R	various	
J3, J4	n/a	Solder Turret	various	

Typical Performance TQP7M9101-PCB2140

Parameter	Conditions ⁽¹⁾	Typical Value			Units
		2110	2140	2170	
Frequency		2110	2140	2170	MHz
Gain		17.6	17.5	17.4	dB
Input Return Loss		15	15	15	dB
Output Return Loss		14	13.5	13	dB
Output P1dB		+24.8	+24.8	+24.6	dBm
OIP3	Pout= +8 dBm/tone, Δf=1 MHz	+39.5	+39.5	+39.5	dBm
WCDMA Channel Power	-55 dBc ACLR, Note 2	+14.5	+14.5	+14.5	dBm
Noise Figure		4.0	3.9	4.1	dB

Notes:

1. Test conditions unless otherwise noted: V_{CC} = +5 V, I_{CO} = 87 mA (typ.), Temp. = +25 °C
2. ACLR Test set-up: 3GPP WCDMA, TM1+64 DPCH, +5 MHz offset, PAR = 10.2 dB at 0.01% Prob

Performance Plots – TQP7M9101-PCB2140

Test conditions unless otherwise noted: $V_{CC} = +5\text{ V}$, $I_{CQ} = 87\text{ mA}$ (typ.), Temp. = $+25\text{ }^{\circ}\text{C}$

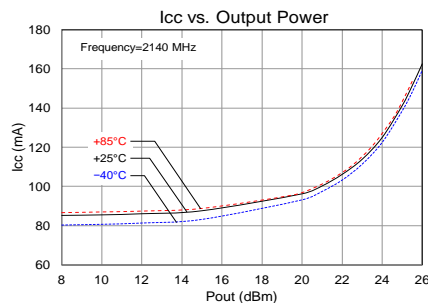
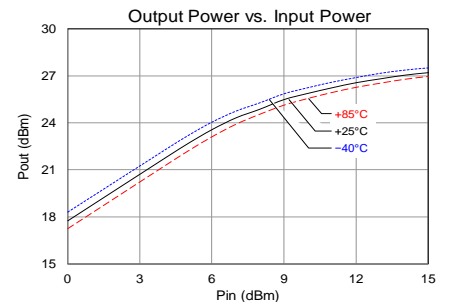
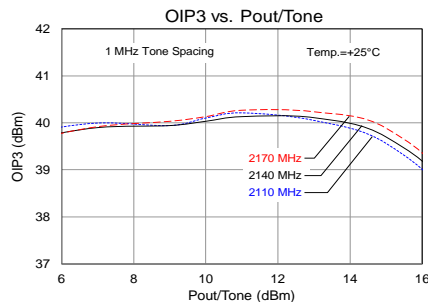
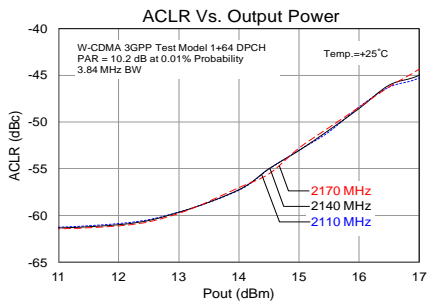
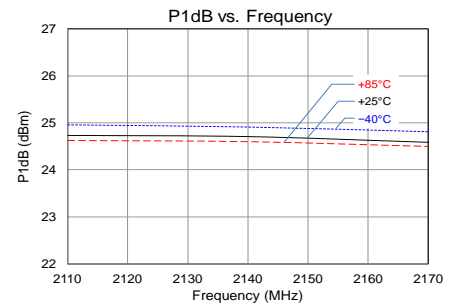
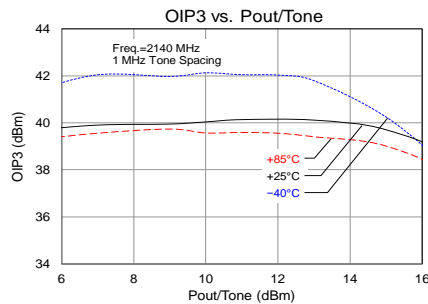
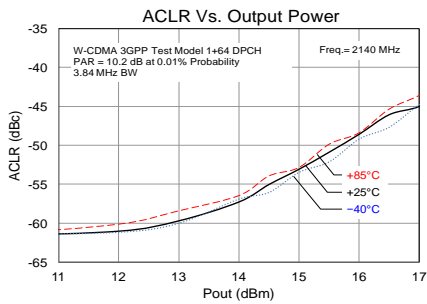
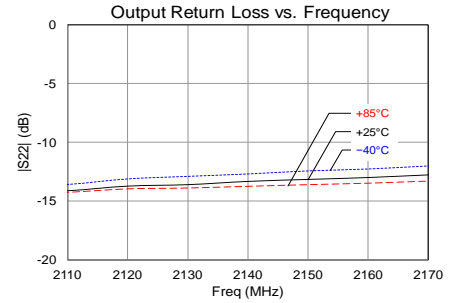
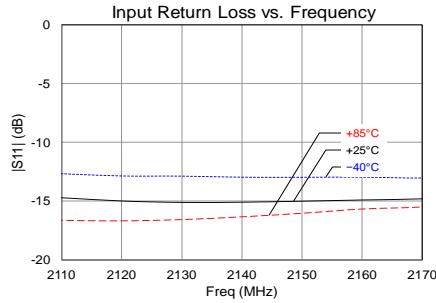
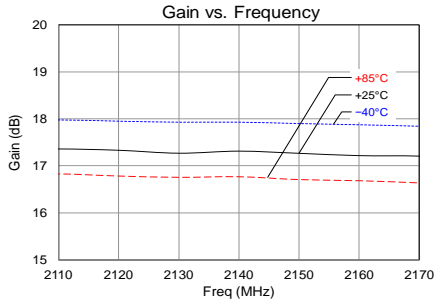

2.5 – 2.7 GHz Evaluation Board (TQP7M9101-PCB2600)

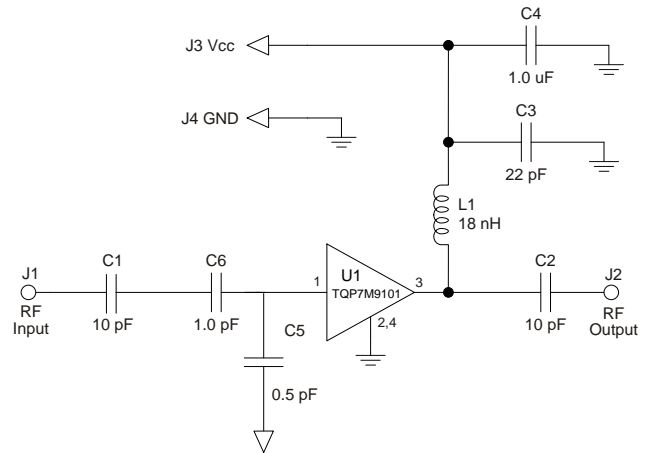
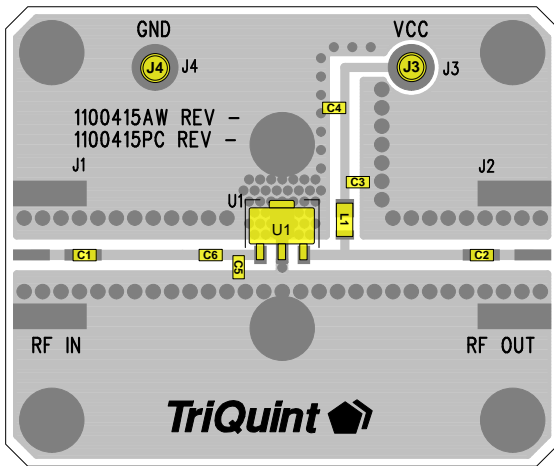

Notes:

1. See Evaluation Board PCB Information for material and stack up.
2. The recommended component values are dependent upon the frequency of operation.
3. All components are of 0603 size unless stated on the schematic.
4. Critical component placement locations:
 Distance from U1 Pin 1 (left edge) to C5 (right edge): 20 mils
 Distance from U1 Pin 1 (left edge) to C6 (right edge): 123 mils

Bill of Material TQP7M9101-PCB2600

Reference Des.	Value	Description	Manuf.	Part Number
n/a	n/a	Printed Circuit Board	Qorvo	1100415
U1	n/a	0.25 W High Linearity Amplifier	Qorvo	TQP7M9101
C6	1.0 pF	CAP, 0603, +/-0.1pF. 200V. NPO/COG	various	
C5	0.5 pF	CAP, 0603, +/-0.1pF. 200V. NPO/COG	various	
C1 , C2	10 pF	Cap., Chip, 0603, +/-5%. 50V NPO/COG	various	
C3	22pF	Cap., Chip, 0603, +/-5%. 50V NPO/COG	various	
C4	1.0 μF	CAP, 0603, 10%, X5R , 10V	various	
L1	18 nH	Inductor, 0805, 5%, Coilcraft CS series	Coilcraft	0805CS-180XJLB
J3, J4	n/a	Solder Turret	various	

Typical Performance TQP7M9101-PCB2600

Parameter	Conditions ⁽¹⁾	Typical Value			Units
Frequency		2500	2600	2700	MHz
Gain		16.5	16.5	16.2	dB
Input Return Loss		9	10	10	dB
Output Return Loss		17	14	13	dB
Output P1dB		+25.1	+24.9	+25.0	dBm
OIP3	Pout= +8 dBm/tone, Δf=1 MHz	+40.2	+40.6	+41.3	dBm
WCDMA Channel Power	-50 dBc ACLR, Note 2	+14.3	+14.4	+14.3	dBm

Notes:

1. Test conditions unless otherwise noted: $V_{CC} = +5V$, $I_{CO} = 87\text{ mA}$ (typ.), Temp. = +25 °C
2. ACLR Test set-up: 3GPP WCDMA, TM1+64 DPCH, +5 MHz offset, PAR = 10.2 dB at 0.01% Prob.

Performance Plots TQP7M9101-PCB2600

Test conditions unless otherwise noted: $V_{CC} = +5\text{ V}$, $I_{CQ} = 87\text{ mA}$ (typ.), Temp. = $+25\text{ }^{\circ}\text{C}$

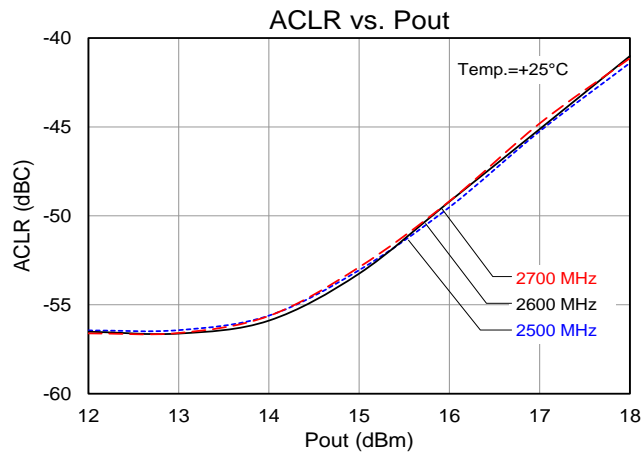
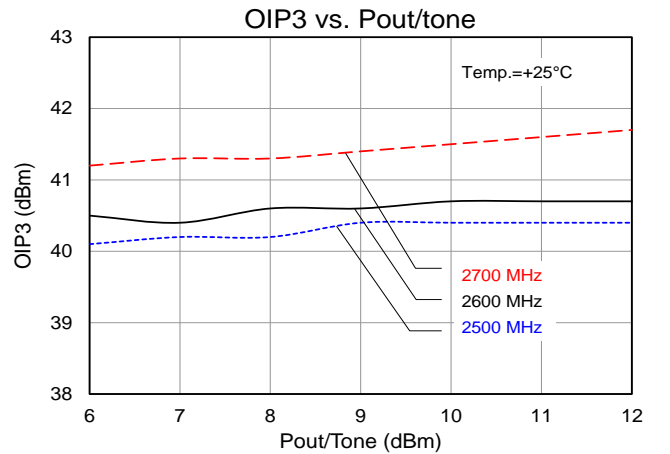
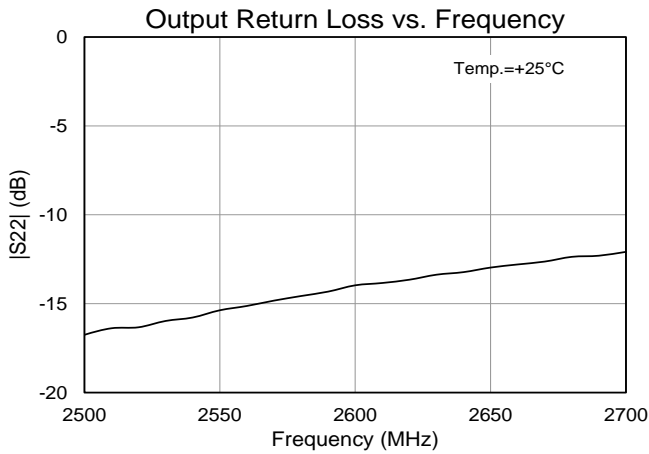
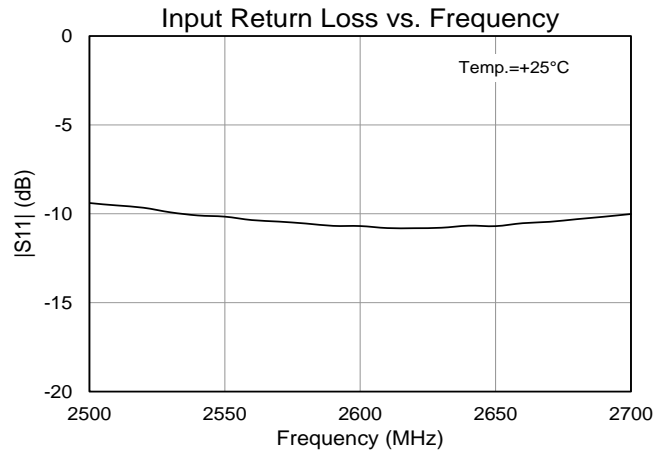
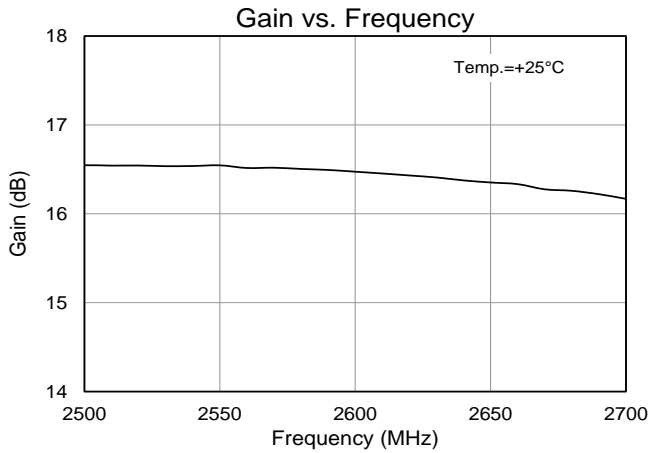

3400 – 3600 MHz Reference Design

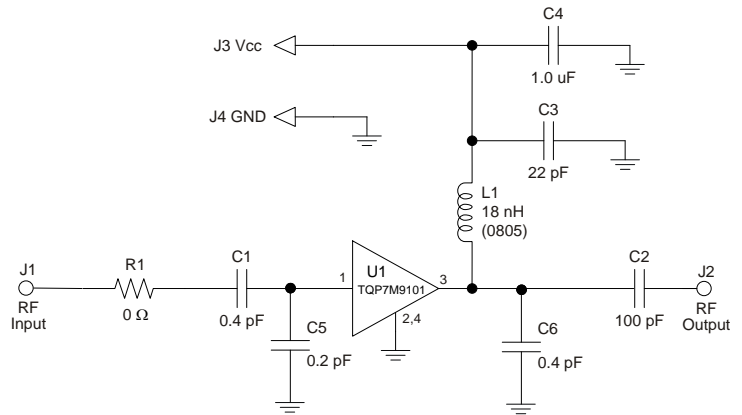
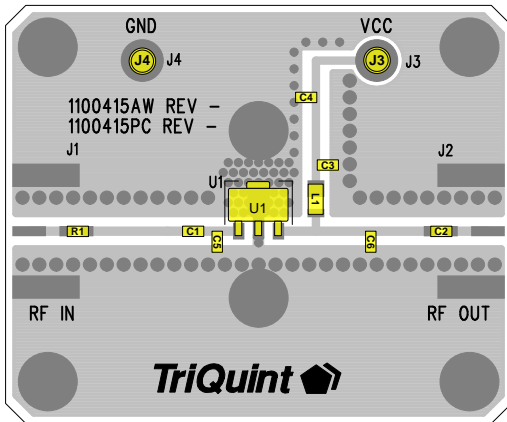

Notes:

1. See Evaluation Board PCB Information for material and stack up.
2. Components shown on the silkscreen but not on the schematic are not used.
3. 0 Ω resistors (R1) may be replaced with copper trace in the target application layout.
4. The recommended component values are dependent upon the frequency of operation.
5. All components are of 0603 size unless stated on the schematic.
6. Critical component placement locations:
 - Distance from U1 Pin 1 (left edge) to C1 (right edge): 90 mils
 - Distance from U1 Pin 1 (left edge) to C5 (right edge): 30 mils
 - Distance from U1 Pin 3 (right edge) to C6 (left edge): 300 mils

Bill of Material 3400 – 3600 MHz Reference Design

Reference Des.	Value	Description	Manuf.	Part Number
n/a	n/a	Printed Circuit Board	Qorvo	1100415
U1	n/a	0.25 W High Linearity Amplifier	Qorvo	TQP7M9101
R1	0 Ω	RES , 0603, 5PCT. 1/16W. CHIP	various	
C1 , C6	0.4 pF	CAP, 0603, ± 0.05 pF, 50V, ACCU-P	AVX	06035J0R4ABSTR
C5	0.2 pF	CAP, 0603, ± 0.05 pF, 50V, ACCU-P	AVX	06035J0R2ABSTR
C2	100 pF	Cap., Chip, 0603, +/-5%. 50V NPO/COG	various	
C3	22 pF	CAP, 0603, 5%, 50V, NPO/COG	various	
C4	1.0 μF	CAP, 0603, 10%, X5R , 10V	various	
L1	18 nH	Inductor, 0805, 5%, Coilcraft CS series	Coilcraft	0805CS-180XJLB

Typical Performance 3400 – 3600 MHz Reference Design

Parameter	Conditions ⁽¹⁾	Typical Value			Units
		3400	3500	3600	
Frequency		3400	3500	3600	MHz
Gain		14.8	15.0	14.7	dB
Input Return Loss		9	17	17	dB
Output Return Loss		16	11	7.5	dB
Output P1dB		+23.7	+23.4	+23.1	dBm
OIP3	Pout= +8 dBm/tone, Δf=1 MHz	+39.5	+39.4	+38.8	dBm
WCDMA Channel Power	-50 dBc ACLR, Note 2	+14.4	+14.1	+13.9	dBm

Notes:

1. Test conditions unless otherwise noted: V_{CC} = +5 V, I_{CQ} = 87 mA (typ.), Temp. = +25 °C
2. ACLR Test set-up: 3GPP WCDMA, TM1+64 DPCH, +5 MHz offset, PAR = 10.2 dB at 0.01% Prob

Performance Plots 3400 – 3600 MHz Reference Design

Test conditions unless otherwise noted: $V_{CC} = +5\text{ V}$, $I_{CQ} = 87\text{ mA}$ (typ.), Temp. = $+25\text{ }^{\circ}\text{C}$

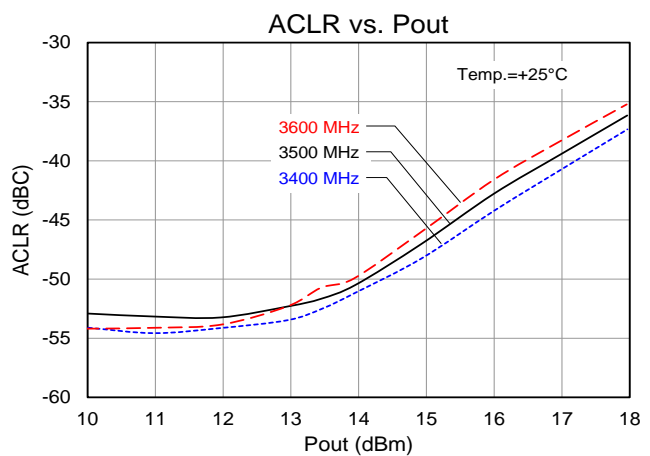
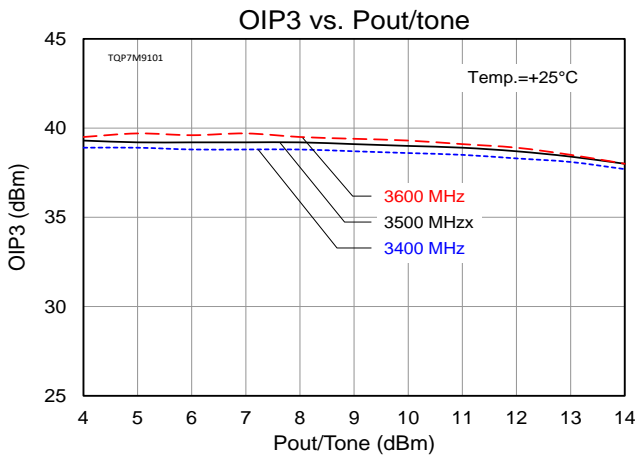
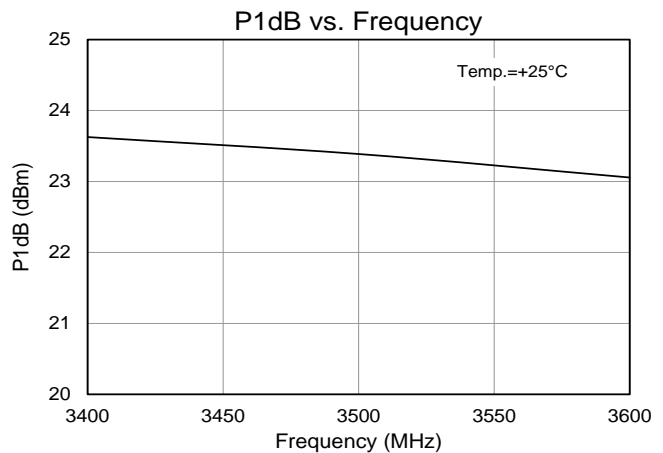
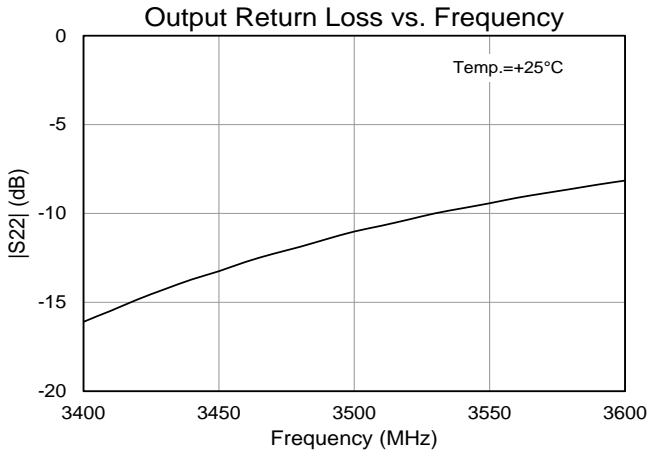
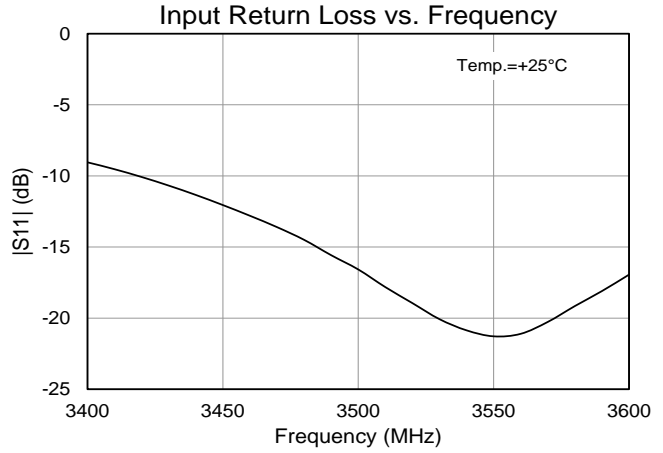
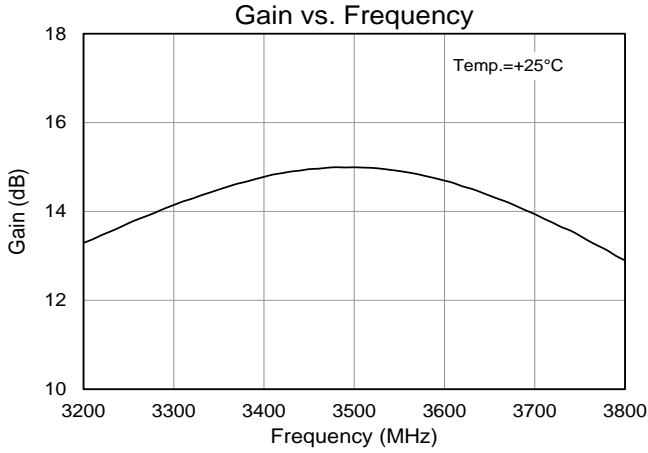

4.4 – 5.0 GHz Reference Design

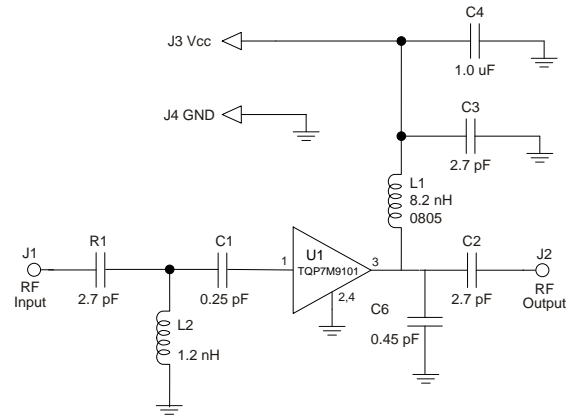
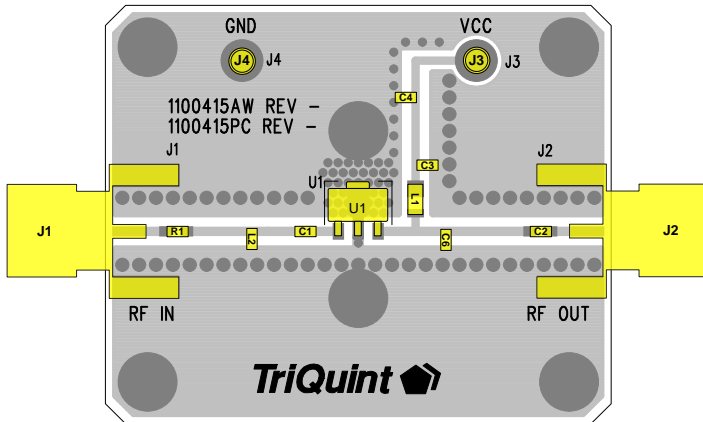

Notes:

1. Components shown on the silkscreen but not on the schematic are not used.
2. 0 Ω resistor can be replaced with copper trace in the target application layout.
3. All components are of 0603 size unless stated on the schematic.
4. The recommended component values are dependent upon the frequency of operation.
5. Critical component placement locations:
 - Distance between U1 Pin 1 Pad (left edge) to C1 (right edge): 10 mils
 - Distance between U1 Pin 1 Pad (left edge) to L2 (right edge): 280 mils
 - Distance between U1 Pin 3 Pad (right edge) to C6 (left edge): 110 mils

Bill of Material 4.4 – 5.0 GHz Reference Design

Reference Des.	Value	Description	Manuf.	Part Number
n/a	n/a	Printed Circuit Board	Qorvo	
U1	n/a	0.25 W High Linearity Amplifier	Qorvo	TQP7M9101
C1	0.25 pF	CAP, 0402, ± 0.02 pF, 50V, ACCU-P	AVX	04021JR25PBS
C6	0.45 pF	CAP, 0603, ± 0.02 pF, 50V, ACCU-P	AVX	06035JR45PBS
L2	1.2 nH	Inductor, 0603, chip	various	
C2, C3, R1	2.7 pF	CAP, 0603, ± 0.1 pF, 50V, NPO/COG	various	
C4	1.0 μF	CAP, 0603, 10%, X5R, 10V	various	
L1	8.2 nH	Inductor, 0805, 5%, Coilcraft CS series	Coilcraft	0805CS-8N2XJLB

Typical Performance 4.4 – 5.0 GHz Reference Design

Parameter	Conditions ⁽¹⁾	Typical Value				Units
		4400	4600	4800	5000	
Frequency		4400	4600	4800	5000	MHz
Gain		12.8	12.9	12.4	11.5	dB
Input Return Loss		8.3	10.9	10.6	8.0	dB
Output Return Loss		18	14	11	8.1	dB
Output P1dB		+23.9	+23.5	+23.9	+23.1	dBm
Output IP3	Pout= +8 dBm/tone, Δf= 1 MHz	+40.1	+40.3	+39.4	+41.3	dBm
Quiescent Collector Current, I _{CC}		86				mA

Notes:

1. Test Conditions: V_{CC}=+5V, Temp.=+25 °C, 50 Ω System

Performance Plots 4.4 – 5.0 GHz Reference Design

Test conditions unless otherwise noted: $V_{CC} = +5\text{ V}$, $I_{CQ} = 87\text{ mA}$ (typ.), Temp. = $+25\text{ }^{\circ}\text{C}$

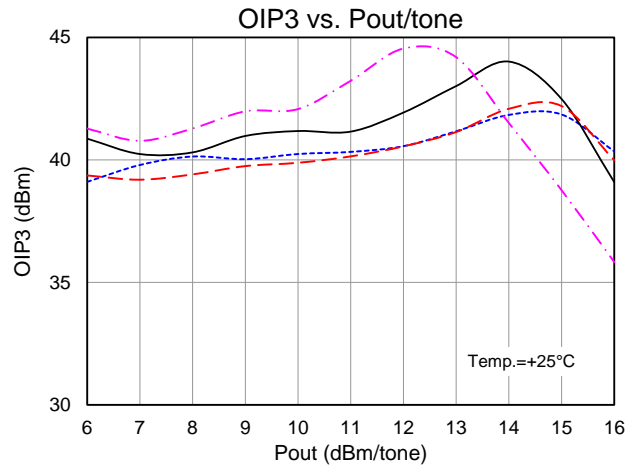
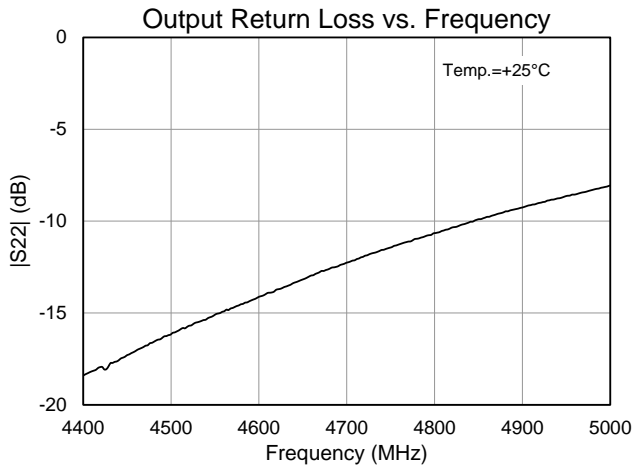
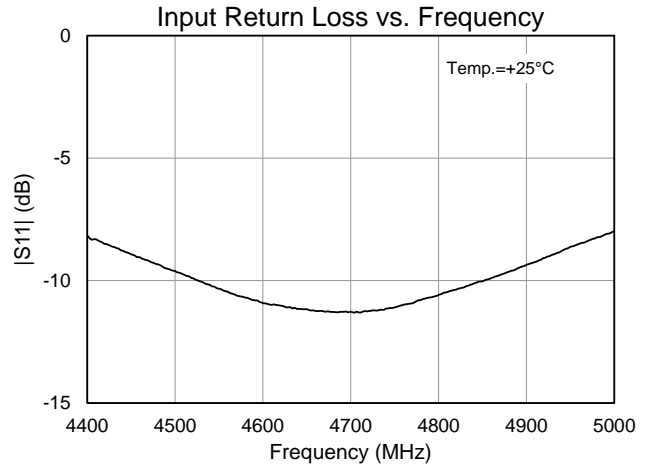
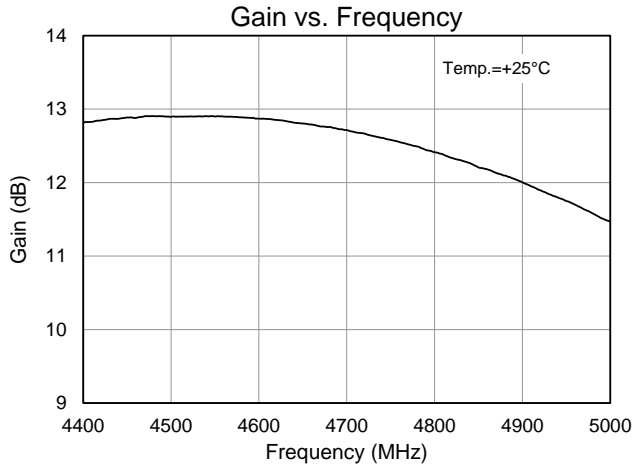

1800 – 2200 MHz Reference Design Optimized for OIP3

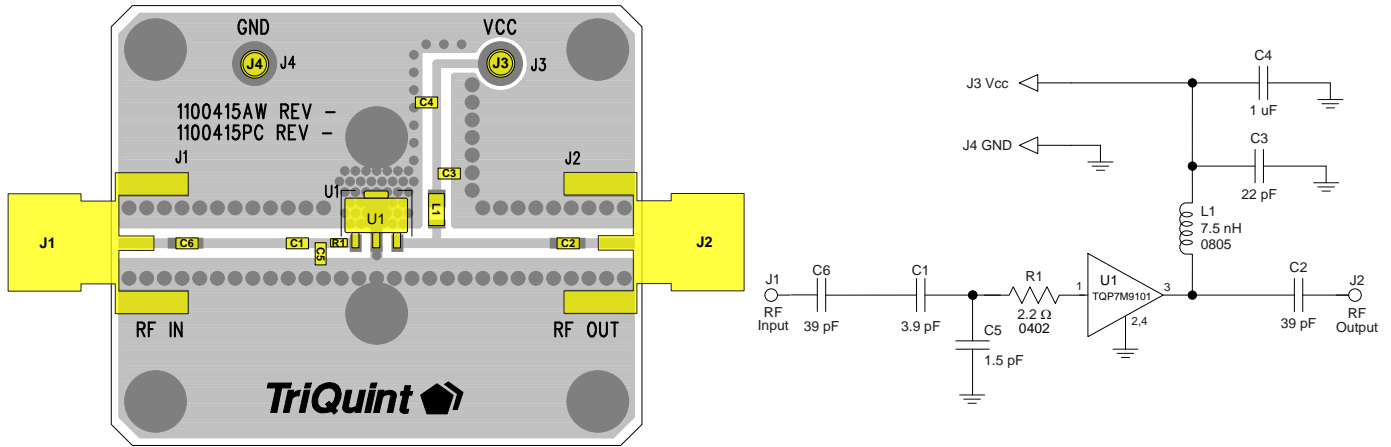

Notes:

- 6. All components are of 0603 size unless stated on the schematic.
- 7. The recommended component values are dependent upon the frequency of operation.
- 8. Critical component placement locations:
 - Distance between U1 Pin 1 Pad to R1 (right edge): 10 mil
 - Distance between U1 Pin 1 Pad to C5 (right edge): 45 mil
 - Distance between U1 Pin 3 Pad to C1 (right edge): 90 mil

Bill of Material 1800 – 2200 MHz Reference Design

Reference Des.	Value	Description	Manuf.	Part Number
n/a	n/a	Printed Circuit Board	Qorvo	
U1	n/a	0.25 W High Linearity Amplifier	Qorvo	TQP7M9101
C1	3.9 pF	CAP, 0603, +/-0.1pF. 200V. NPO/COG	various	
C5	1.5 pF	CAP, 0603, +/-0.1pF. 200V. NPO/COG	various	
C2, C6	39 pF	Cap., Chip, 0603, +/-5%. 50V NPO/COG	various	
C3	22 pF	Cap., Chip, 0603, +/-5%. 50V NPO/COG	various	
R1	2.2 Ω	Res., Chip, 0603, +/-1%, 1/10W	various	
C4	1.0 μF	CAP, 0603, 10%, X5R , 10V	various	
L1	7.5 nH	Inductor, 0805, 5%, Coilcraft CS series	Coilcraft	0805CS-7N5XJLB

Typical Performance 1800 – 2200 MHz Reference Design

Parameter	Conditions	Typical Value					Units
		1800	1900	2000	2100	2200	
Frequency		1800	1900	2000	2100	2200	MHz
Gain		16.7	16.6	16.3	15.9	15.6	dB
Input Return Loss		10	12	13	12	10	dB
Output Return Loss		11	11	10	9.5	8.5	dB
Output P1dB		+23.8	+24.0	+24.0	+24.2	+24.3	dBm
Output IP3	Pout= +14 dBm/tone, Δf= 1 MHz	+43.4	+47.8	+45.9	+43.8	+42.3	dBm
Quiescent Collector Current, I _{CQ}		87					mA

Notes:

- 1. Test Conditions: V_{CC}=+5 V, Temp.=+25 °C, 50 Ω System

Performance Plots 1800 – 2200 MHz Reference Design

Test conditions unless otherwise noted: $V_{CC} = +5\text{ V}$, $I_{CQ} = 87\text{ mA}$ (typ.), Temp. = $+25\text{ }^{\circ}\text{C}$

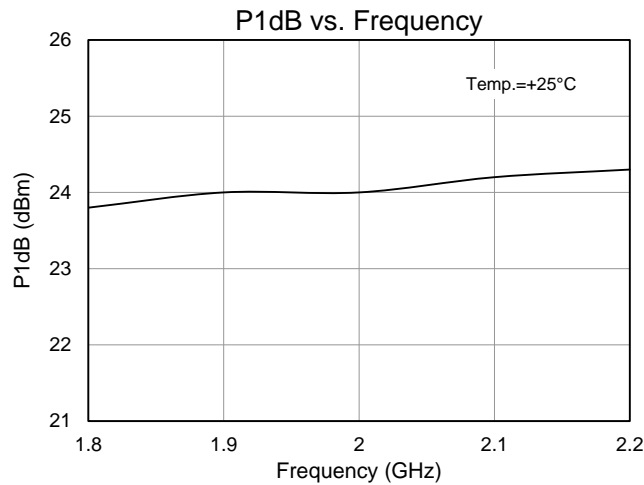
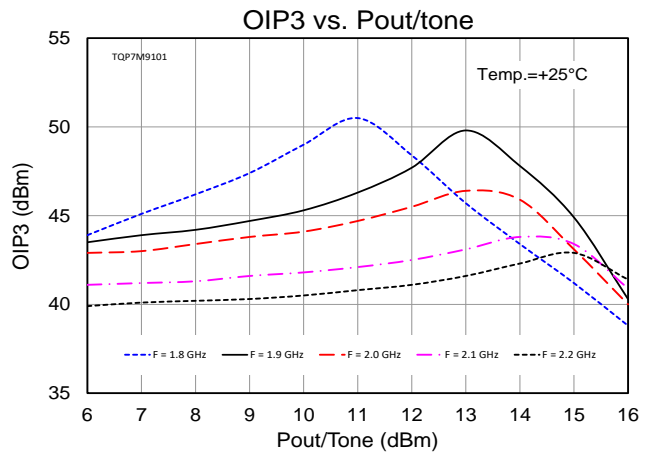
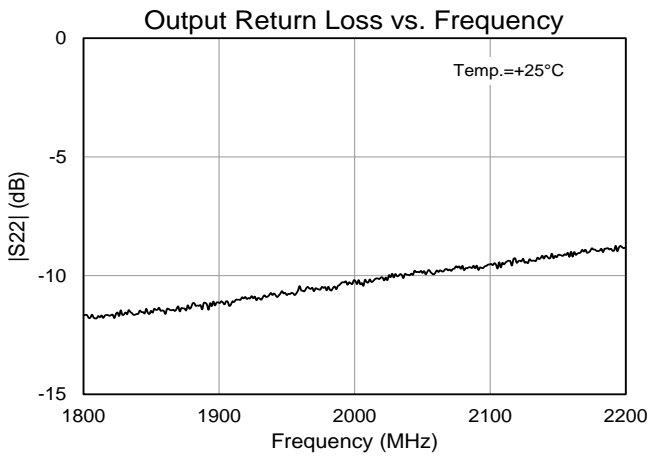
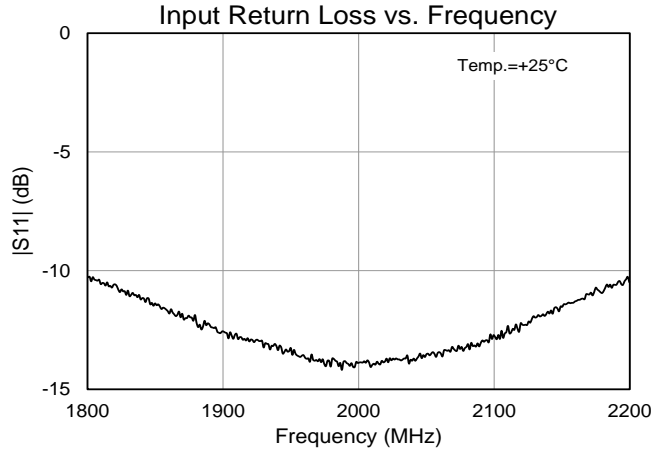
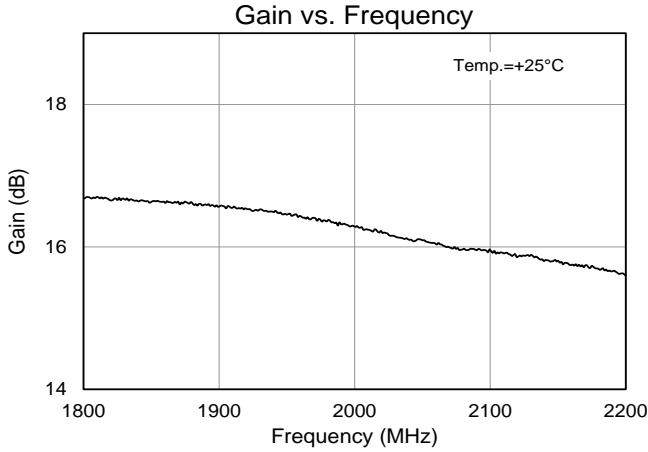

Pin Configuration and Description

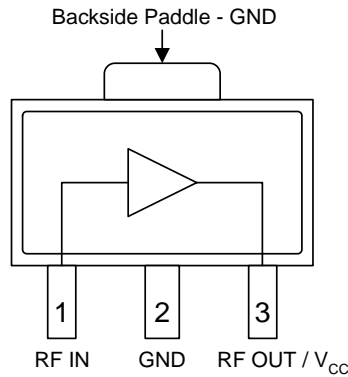

Pin No.	Label	Description
1	RF IN	RF Input. External DC Block required. Requires conjugate match for optimal performance.
2, Backside Paddle	GND	RF/DC ground. Use recommended via hole pattern to minimize inductance and thermal resistance. See PCB Mounting Pattern for suggested footprint.
3	RF OUT / V _{CC}	RF output, matched to 50 ohms. External DC Block, RF choke and bias voltage required.

Evaluation Board PCB Information

Qorvo PCB 1100415 Material and Stack-up

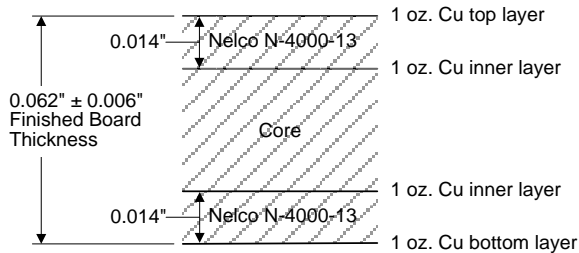

50 ohm line dimensions: width = .031"
spacing = .035".

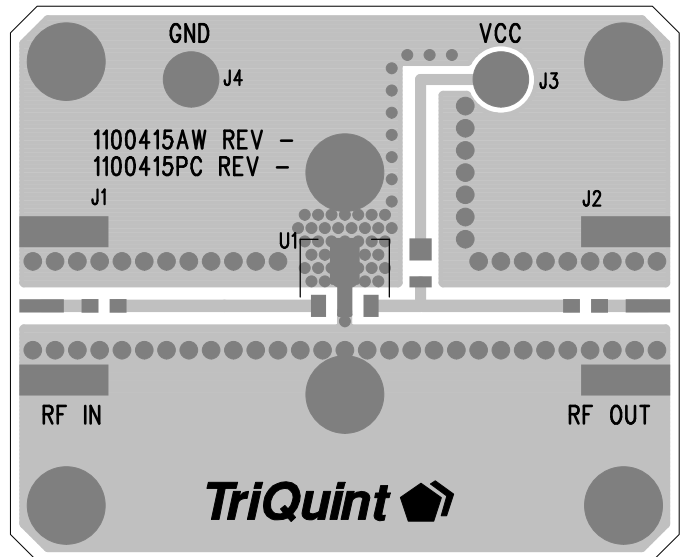

Package Marking and Dimensions

Package Marking

Product ID:
7M9101
Trace code:
XXXX

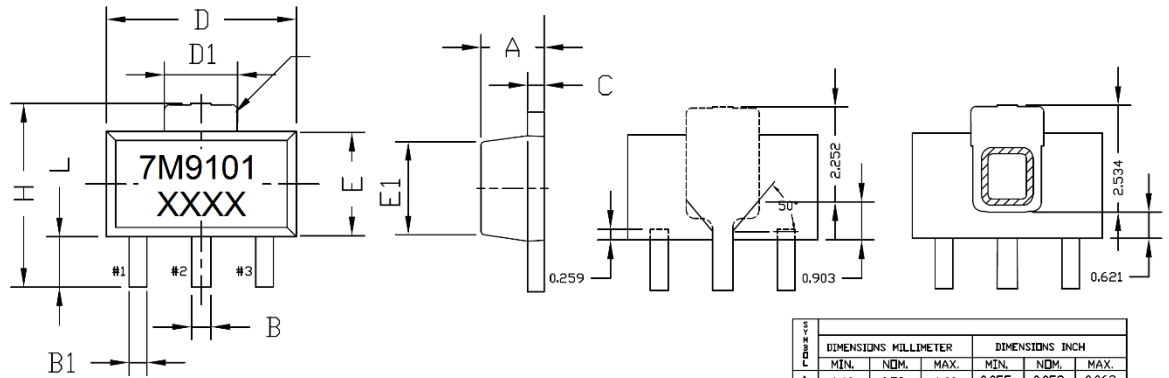

Feature	DIMENSIONS MILLIMETER			DIMENSIONS INCH		
	MIN.	NOM.	MAX.	MIN.	NOM.	MAX.
A	1.40	1.50	1.60	0.055	0.059	0.063
B	0.42	0.49	0.56	0.017	0.019	0.022
B1	0.36	0.42	0.44	0.014	0.016	0.019
C	0.35	0.40	0.43	0.014	0.016	0.017
D	4.39	4.50	4.60	0.173	0.177	0.181
D1	1.40	1.62	1.83	0.055	0.062	0.072
E	2.29	2.44	2.60	0.090	0.098	0.102
E1	1.77	2.03	2.29	0.070	0.074	0.090
e	1.50 BSC			0.059 BSC		
e1	3.00 BSC			0.118 BSC		
H	3.84	4.04	4.25	0.151	0.155	0.167
L	0.74	0.97	1.20	0.029	0.041	0.047

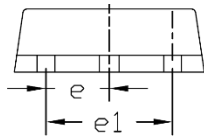

NOTES :
1. DIMENSIONING & TOLERANCING PER ANSI.Y14.5M-1982
2. CONTROLLING DIMENSION : MILLIMETER CONVERTED INCH ARE NOT NECESSARILY EXACT.
3. DIMENSION B1, 2 PLACES.

Notes:

1. The terminal #1 identifier and terminal numbering conform to JESD 95-1 SPP-012.
2. Trace code up to 4 characters to be assigned by sub-contractor.

PCB Mounting Pattern

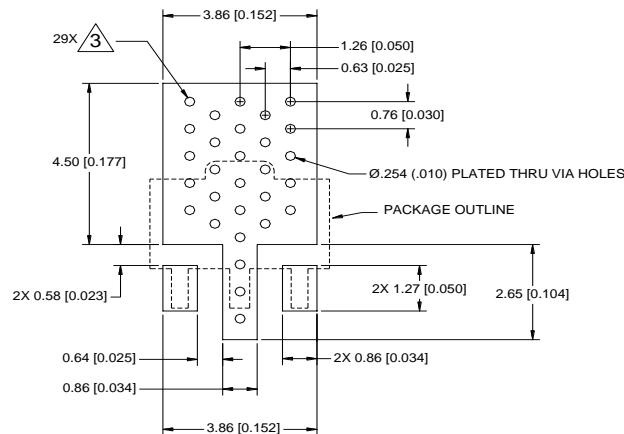

Notes:

1. All dimensions are in millimeters [inches]. Angles are in degrees.
2. Use 1 oz. copper minimum for top and bottom layer metal.
3. Via holes are required under the backside paddle of this device for proper RF/DC grounding and thermal conductivity.
4. Do not remove or minimize via hole structure in the PCB. Thermal and RF grounding is critical.
5. We recommend a 0.35mm (#80/.0135") diameter bit for drilling via holes and a final plated thru diameter of 0.25 mm (0.010").
6. Ensure good package backside paddle solder attach for reliable operation and best electrical performance.

Tape and Reel Information – Carrier and Cover Tape Dimensions



Feature	Measure	Symbol	Size (in)	Size (mm)
Cavity	Length	A0	0.181	4.60
	Width	B0	0.193	4.90
	Depth	K0	0.075	1.90
	Pitch	P1	0.315	8.00
Centerline Distance	Cavity to Perforation - Length Direction	P2	0.079	2.00
	Cavity to Perforation - Width Direction	F	0.217	5.50
Cover Tape	Width	C	0.362	9.20
Carrier Tape	Width	W	0.472	12.0

Tape and Reel Information – Reel Dimensions (7")

Standard T/R size = 1,000 pieces on a 7" reel.



Feature	Measure	Symbol	Size (in)	Size (mm)
Flange	Diameter	A	6.969	177.0
	Thickness	W2	0.717	18.2
	Space Between Flange	W1	0.504	12.8
Hub	Outer Diameter	N	2.283	58.0
	Arbor Hole Diameter	C	0.512	13.0
	Key Slit Width	B	0.079	2.0
	Key Slit Diameter	D	0.787	20.0

Tape and Reel Information – Tape Length and Label Placement



- Notes:
1. Empty part cavities at the trailing and leading ends are sealed with cover tape. See EIA 481-1-A.
 2. Labels are placed on the flange opposite the sprockets in the carrier tape.

Handling Precautions

Parameter	Rating	Standard
ESD – Human Body Model (HBM)	Class 2	ESDA / JEDEC JS-001-2014
ESD – Charged Device Model (CDM)	Class C3	ESDA / JEDEC JS-002-2014
MSL – Moisture Sensitivity Level	Level 1	IPC/JEDEC J-STD-020



Caution!
ESD-Sensitive Device

Solderability

Compatible with lead-free (260°C max. reflow temp.) soldering process.

Solder profiles available upon request.

Contact plating: Annealed Matte Tin

RoHS Compliance

This part is compliant with 2011/65/EU RoHS directive (Restrictions on the Use of Certain Hazardous Substances in Electrical and Electronic Equipment) as amended by Directive 2015/863/EU.

This product also has the following attributes:

- Lead Free
- Halogen Free (Chlorine, Bromine)
- Antimony Free
- TBBP-A (C₁₅H₁₂Br₄O₂) Free
- SVHC Free



Contact Information

For the latest specifications, additional product information, worldwide sales and distribution locations:

Web: www.qorvo.com

Tel: 1-844-890-8163

Email: customer.support@qorvo.com

Important Notice

The information contained herein is believed to be reliable; however, Qorvo makes no warranties regarding the information contained herein and assumes no responsibility or liability whatsoever for the use of the information contained herein. All information contained herein is subject to change without notice. Customers should obtain and verify the latest relevant information before placing orders for Qorvo products. The information contained herein or any use of such information does not grant, explicitly or implicitly, to any party any patent rights, licenses, or any other intellectual property rights, whether with regard to such information itself or anything described by such information. **THIS INFORMATION DOES NOT CONSTITUTE A WARRANTY WITH RESPECT TO THE PRODUCTS DESCRIBED HEREIN, AND QORVO HEREBY DISCLAIMS ANY AND ALL WARRANTIES WITH RESPECT TO SUCH PRODUCTS WHETHER EXPRESS OR IMPLIED BY LAW, COURSE OF DEALING, COURSE OF PERFORMANCE, USAGE OF TRADE OR OTHERWISE, INCLUDING THE IMPLIED WARRANTIES OF MERCHANTABILITY AND FITNESS FOR A PARTICULAR PURPOSE.**

Without limiting the generality of the foregoing, Qorvo products are not warranted or authorized for use as critical components in medical, life-saving, or life-sustaining applications, or other applications where a failure would reasonably be expected to cause severe personal injury or death.

Copyright 2020 © Qorvo, Inc. | Qorvo is a registered trademark of Qorvo, Inc.

Данный компонент на территории Российской Федерации

Вы можете приобрести в компании MosChip.

Для оперативного оформления запроса Вам необходимо перейти по данной ссылке:

<http://moschip.ru/get-element>

Вы можете разместить у нас заказ для любого Вашего проекта, будь то серийное производство или разработка единичного прибора.

В нашем ассортименте представлены ведущие мировые производители активных и пассивных электронных компонентов.

Нашей специализацией является поставка электронной компонентной базы двойного назначения, продукции таких производителей как XILINX, Intel (ex.ALTERA), Vicor, Microchip, Texas Instruments, Analog Devices, Mini-Circuits, Amphenol, Glenair.

Сотрудничество с глобальными дистрибьюторами электронных компонентов, предоставляет возможность заказывать и получать с международных складов практически любой перечень компонентов в оптимальные для Вас сроки.

На всех этапах разработки и производства наши партнеры могут получить квалифицированную поддержку опытных инженеров.

Система менеджмента качества компании отвечает требованиям в соответствии с ГОСТ Р ИСО 9001, ГОСТ РВ 0015-002 и ЭС РД 009

Офис по работе с юридическими лицами:

105318, г.Москва, ул.Щербаковская д.3, офис 1107, 1118, ДЦ «Щербаковский»

Телефон: +7 495 668-12-70 (многоканальный)

Факс: +7 495 668-12-70 (доб.304)

E-mail: info@moschip.ru

Skype отдела продаж:

moschip.ru

moschip.ru_4

moschip.ru_6

moschip.ru_9