

Part No. 1002857

EtherHelix™ Mission Critical GPS Antenna

1.575 GHz Circularly Polarized

Supports: Aviation, GPS Navigation Systems, Fire & Rescue, Asset Tracking, Automotive, Security, Home Network application



EtherHelix GPS Antenna Quadhelix design

1.575 GHz

KEY BENEFITS

Smallest Effective Size

Ethertronics' antennas require a smaller keep-out area for surrounding components, leading to a smaller effective size.

High Performance

Ethertronics' high efficiency and simple design rules lower development risk and speed time-to-market without sacrificing performance. Plus, high RF selectivity eliminates the cost and space for band-pass circuitry.

Reliability

Products are the latest RoHS version compliant.

APPLICATIONS

- GPS enabled phones
- GPS navigation systems
- Mobile devices
- Tracking
- Wireless Monitoring
- IoT
- Medical/Healthcare applications
- Mission Critical Applications
- Commercial/Communication
- Radar
- Industrial Automotive
- First Responders

EtherHelix™ series of GPS Quad Helix Isolated Magnetic Dipole™ (IMD) antennas deliver on the key needs of device designers for higher functionality and performance in the worlds smallest Stand alone Circular polarized external and internal designs. These innovative antennas provide compelling advantages for GPS enabled cell phones, navigation equipment, and other mobile devices.

Real-World Performance and Implementation

Antennas may look alike on the outside, but the important difference is inside. Other antennas may contain simple PIFA or monopole patch designs that inter-act with their surroundings, complicating component layout or changing performance with use position. Ethertronics' antennas utilize patented IMD technology to deliver a unique size and performance combination.

Electrical Specifications

Measured in Free space

Frequency	GPS - 1.575 GHz
Polarization	Right Hand CP (RHCP)
Peak Gain (dBi)	-3.0 [-5 dB at Zenith]
Beam-width	120 degrees (Axial Ratio < 3dB)
Axial Ratio (dB)	< 1.5 at zenith
Average Efficiency (%)	27
VSWR Match	2.0:1 max
Feed Point Impedance	50 ohms unbalanced
Power Handling	0.5 Watt CW

Mechanical Specifications & Ordering Part Number

Ordering Part Number	1002857
Size (mm)	34.93 height 15.0 diameter
Connector	SMA Male
Weight (grams)	11.8
Mechanical Rating	IP 68 UV Protected
Connector	SMA Male
Operative Temperature (°C)	-40 to +85
Humidity(°C)	95% RH @ 54
Packaging	Trays: 60 per tray - 300 per master carton



Ethertronics' EtherHelix GPS Antenna Specifications.
Ethertronics produces a wide variety of standard and custom antennas to meet user needs.

Efficiency, Axial Ratio, RHCP / LHCP Plots

Typical performance, measured in free space

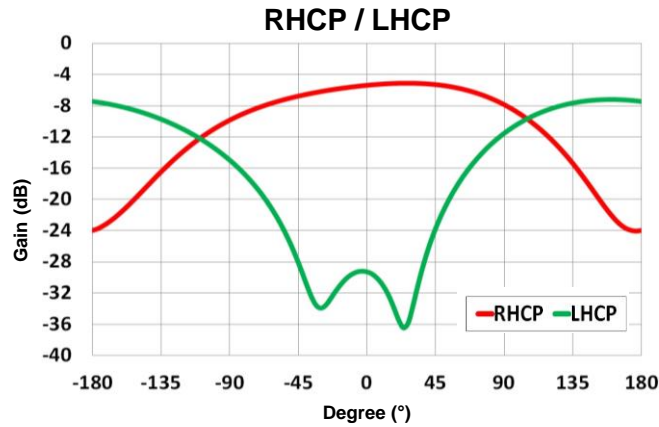
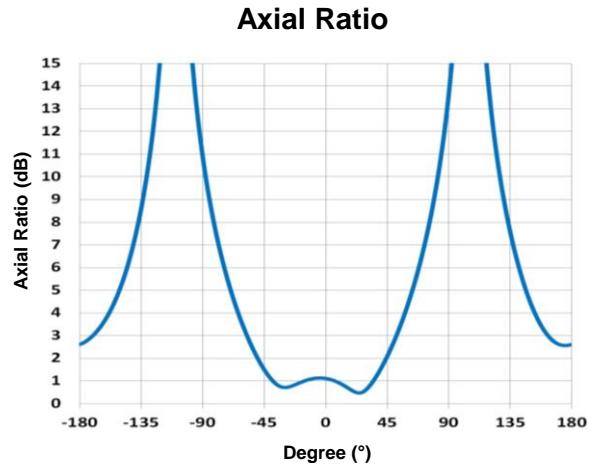
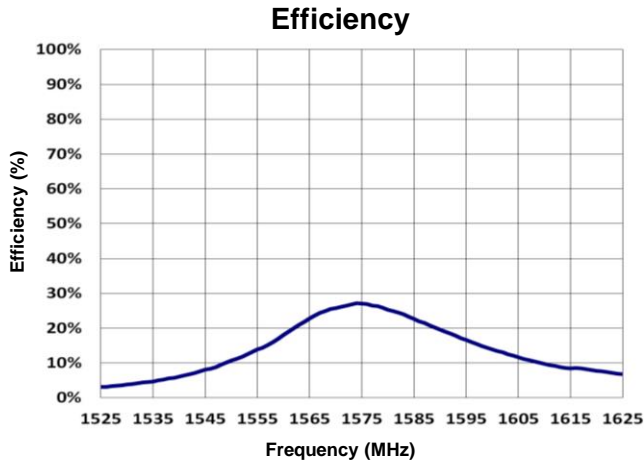

Antenna Radiation Patterns

Typical performance, measured in free space @ 1575 GHz

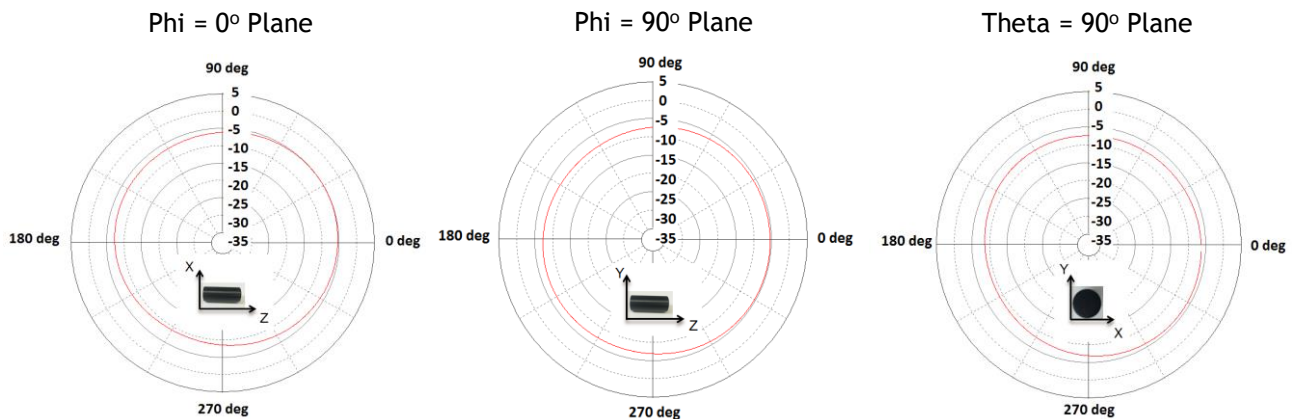



Ethertronics' EtherHelix GPS Antenna Specifications.
Ethertronics produces a wide variety of standard and custom antennas to meet user needs.

Mechanical Dimensions

Typical antenna dimensions (mm)

Part Number	A (mm)	B (mm)	C (mm)
1002857	34.93 ± 0.5	15.0 ± 0.5	1.5 ± 0.3

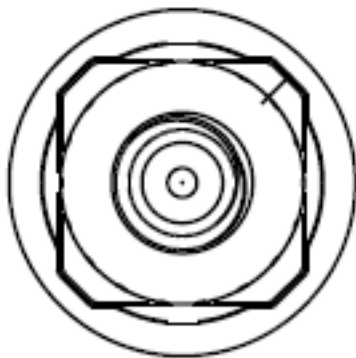
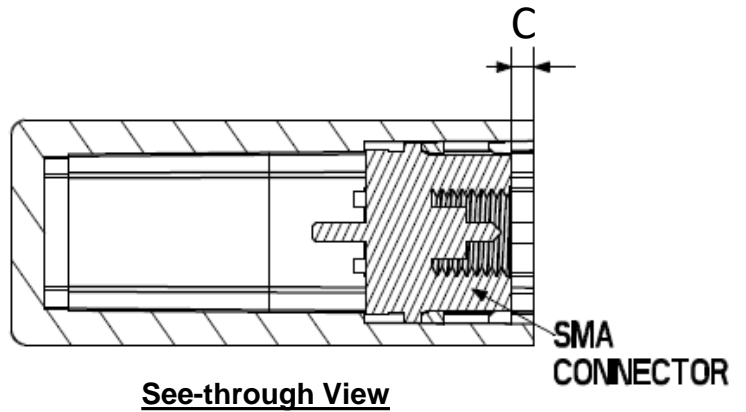
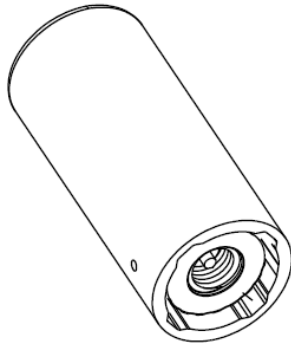

Connector View

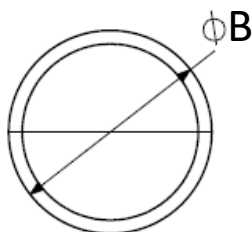
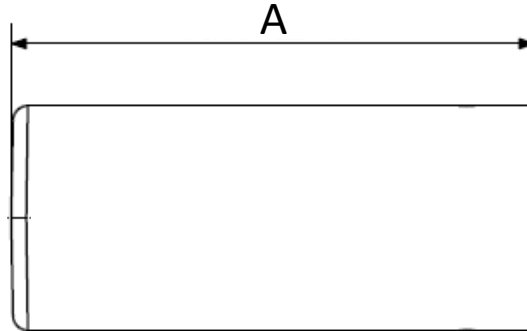

Diameter View



Bottom View

Данный компонент на территории Российской Федерации

Вы можете приобрести в компании MosChip.

Для оперативного оформления запроса Вам необходимо перейти по данной ссылке:

<http://moschip.ru/get-element>

Вы можете разместить у нас заказ для любого Вашего проекта, будь то серийное производство или разработка единичного прибора.

В нашем ассортименте представлены ведущие мировые производители активных и пассивных электронных компонентов.

Нашей специализацией является поставка электронной компонентной базы двойного назначения, продукции таких производителей как XILINX, Intel (ex.ALTERA), Vicor, Microchip, Texas Instruments, Analog Devices, Mini-Circuits, Amphenol, Glenair.

Сотрудничество с глобальными дистрибьюторами электронных компонентов, предоставляет возможность заказывать и получать с международных складов практически любой перечень компонентов в оптимальные для Вас сроки.

На всех этапах разработки и производства наши партнеры могут получить квалифицированную поддержку опытных инженеров.

Система менеджмента качества компании отвечает требованиям в соответствии с ГОСТ Р ИСО 9001, ГОСТ РВ 0015-002 и ЭС РД 009

Офис по работе с юридическими лицами:

105318, г.Москва, ул.Щербаковская д.3, офис 1107, 1118, ДЦ «Щербаковский»

Телефон: +7 495 668-12-70 (многоканальный)

Факс: +7 495 668-12-70 (доб.304)

E-mail: info@moschip.ru

Skype отдела продаж:

moschip.ru

moschip.ru_4

moschip.ru_6

moschip.ru_9