

EL7202, EL7212, EL7222

High Speed, Dual Channel Power MOSFET Drivers

FN7282
Rev.2.01
Feb 18, 2020

The EL7202, EL7212, EL7222 ICs are matched dual-drivers that improve the operation of the industry standard DS0026 clock drivers. The Elantec versions are very high speed drivers capable of delivering peak currents of 2.0 amps into highly capacitive loads. The high speed performance is achieved by means of a proprietary "Turbo-Drive" circuit that speeds up input stages by tapping the wider voltage swing at the output. Improved speed and drive capability are enhanced by matched rise and fall delay times. These matched delays maintain the integrity of input-to-output pulse-widths to reduce timing errors and clock skew problems. This improved performance is accompanied by a 10 fold reduction in supply currents over bipolar drivers, yet without the delay time problems commonly associated with CMOS devices. Dynamic switching losses are minimized with non-overlapped drive techniques.

Pinouts



Manufactured under U.S. Patent Nos. 5,334,883, #5,341,047

Features

- Industry standard driver replacement
- Improved response times
- Matched rise and fall times
- Reduced clock skew
- Low output impedance
- Low input capacitance
- High noise immunity
- Improved clocking rate
- Low supply current
- Wide operating voltage range
- Pb-Free available (RoHS compliant)

Applications

- Clock/line drivers
- CCD Drivers
- Ultra-sound transducer drivers
- Power MOSFET drivers
- Switch mode power supplies
- Class D switching amplifiers
- Ultrasonic and RF generators
- Pulsed circuits

Ordering Information

Part Number	PART MARKING	TAPE & REEL	PACKAGE	PKG. DWG. #
EL7202CN (No longer available, recommended replacement: EL7202CSZ)	EL7202CN	-	8 Ld PDIP	E8.3
EL7202CSZ (See Note)	7202CSZ	-	8 Ld SOIC (Pb-free)	M8.15E
EL7202CSZ-T7 (See Note)	7202CSZ	7"	8 Ld SOIC (Pb-free)	M8.15E
EL7202CSZ-T13 (See Note)	7202CSZ	13"	8 Ld SOIC (Pb-free)	M8.15E
EL7212CNZ	EL7212CN Z	-	8 Ld PDIP* (Pb-free)	E8.3
EL7212CSZ (See Note)	7212CSZ	-	8 Ld SOIC (Pb-free)	M8.15E
EL7212CSZ-T7 (See Note)	7212CSZ	7"	8 Ld SOIC (Pb-free)	M8.15E
EL7212CSZ-T13 (See Note)	7212CSZ	13"	8 Ld SOIC (Pb-free)	M8.15E
EL7222CSZ (See Note)	7222CSZ	-	8 Ld SOIC (Pb-free)	M8.15E
EL7222CSZ-T7 (See Note)	7222CSZ	7"	8 Ld SOIC (Pb-free)	M8.15E
EL7222CSZ-T13 (See Note)	7222CSZ	13"	8 Ld SOIC (Pb-free)	M8.15E

NOTE: Pb-free products employ special Pb-free material sets; molding compounds/die attach materials and 100% matte tin plate termination finish, which are RoHS compliant and compatible with both SnPb and Pb-free soldering operations. Pb-free products are MSL classified at Pb-free peak reflow temperatures that meet or exceed the Pb-free requirements of IPC/JEDEC J STD-020.

*Pb-free PDIPs can be used for through hole wave solder processing only. They are not intended for use in Reflow solder processing applications.

Absolute Maximum Ratings ($T_A = 25^\circ\text{C}$)

Supply (V+ to Gnd)	16.5V	Operating Junction Temperature	125°C
Input Pins	-0.3V to +0.3V above V+	Power Dissipation	
Combined Peak Output Current4A	SOIC570mW
Storage Temperature Range	-65°C to +150°C	PDIP	1050mW
Ambient Operating Temperature	-40°C to +85°C		

CAUTION: Stresses above those listed in "Absolute Maximum Ratings" may cause permanent damage to the device. This is a stress only rating and operation of the device at these or any other conditions above those indicated in the operational sections of this specification is not implied.

IMPORTANT NOTE: All parameters having Min/Max specifications are guaranteed. Typical values are for information purposes only. Unless otherwise noted, all tests are at the specified temperature and are pulsed tests, therefore: $T_J = T_C = T_A$

DC Electrical Specifications $T_A = 25^\circ\text{C}$, V = 15V unless otherwise specified

parameter	Description	Test Conditions	Min	Typ	Max	Units
INPUT						
V_{IH}	Logic "1" Input Voltage		2.4			V
I_{IH}	Logic "1" Input Current	@V+		0.1	10	μA
V_{IL}	Logic "0" Input Voltage				0.8	V
I_{IL}	Logic "0" Input Current	@0V		0.1	10	μA
V_{HVS}	Input Hysteresis			0.3		V
OUTPUT						
R_{OH}	Pull-Up Resistance	$I_{OUT} = -100\text{mA}$		3	6	Ω
R_{OL}	Pull-Down Resistance	$I_{OUT} = +100\text{mA}$		4	6	Ω
I_{PK}	Peak Output Current	Source Sink		2 2		A
I_{DC}	Continuous Output Current	Source/Sink	100			mA
POWER SUPPLY						
I_S	Power Supply Current	Inputs High/EL7202 Inputs High/EL7212 Inputs High/EL7222		4.5 1 2.5	7.5 2.5 5.0	mA
V_S	Operating Voltage		4.5		15	V

AC Electrical Specifications $T_A = 25^\circ\text{C}$, V = 15V unless otherwise specified

parameter	Description	Test Conditions	Min	Typ	Max	Units
SWITCHING CHARACTERISTICS						
t_R	Rise Time	$C_L = 500\text{pF}$ $C_L = 1000\text{pF}$		7.5 10	20	ns
t_F	Fall Time	$C_L = 500\text{pF}$ $C_L = 1000\text{pF}$		10 13	20	ns
t_{D1}	Turn-On Delay Time	See Timing Table		18	25	ns
t_{D2}	Turn-Off Delay Time	See Timing Table		20	25	ns

Timing Table

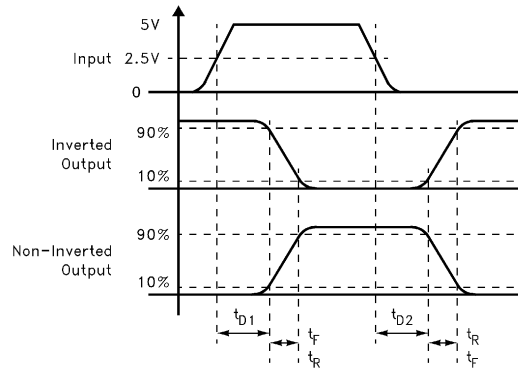

Standard Test Configuration

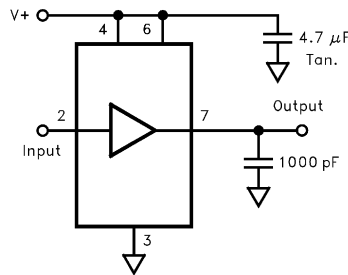

Simplified Schematic

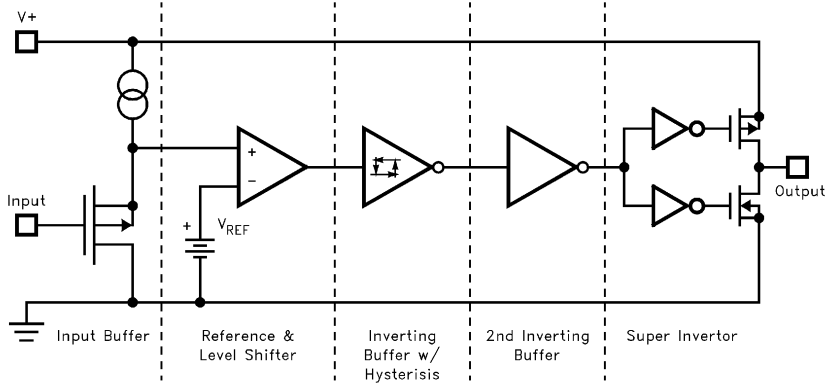

Typical Performance Curves

MAX POWER/DERATING CURVES

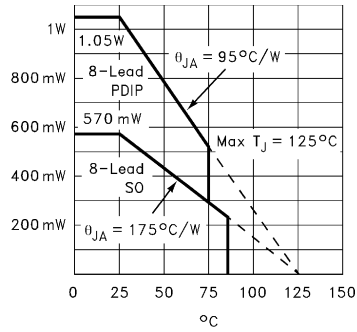

SWITCH THRESHOLD vs SUPPLY VOLTAGE

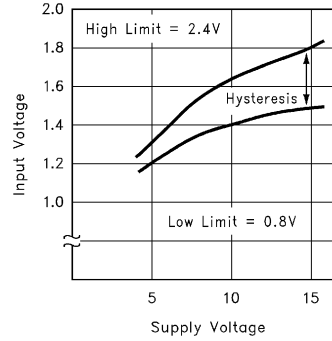

INPUT CURRENT vs VOLTAGE

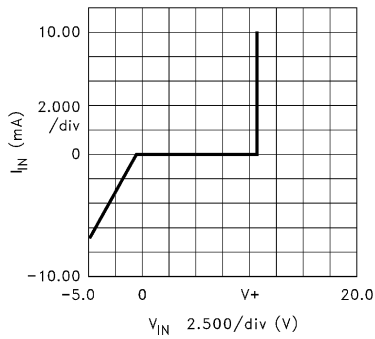

PEAK DRIVE vs SUPPLY VOLTAGE

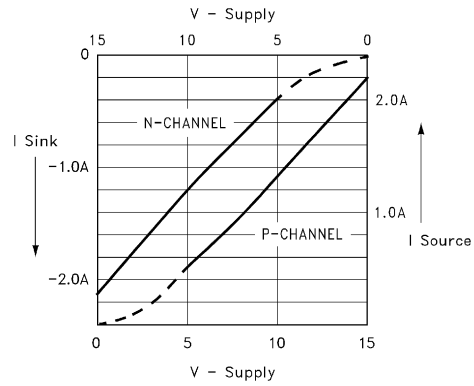

QUIESCENT SUPPLY CURRENT

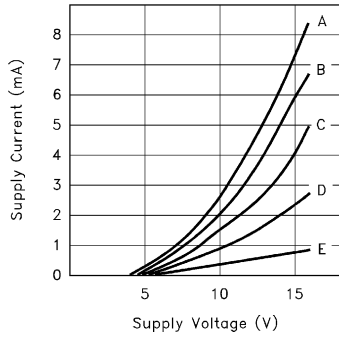

CASE:

Device	Input Level	Curve
EL7202	GND	A
EL7202	GND, V+	B
EL7202	V+	C
EL7212	GND	C
EL7212	GND, V+	D
EL7212	V+	E
EL7222	GND	B
EL7222	GND, V+	C
EL7222	V+	D

"ON" RESISTANCE vs SUPPLY VOLTAGE

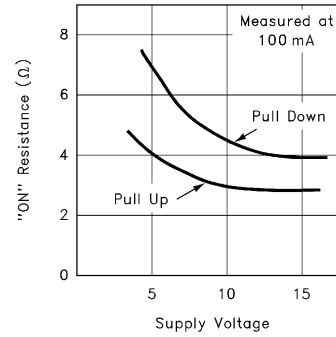

Typical Performance Curves (Continued)

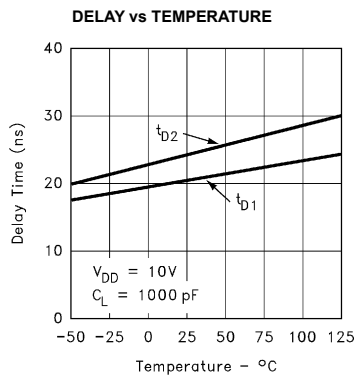
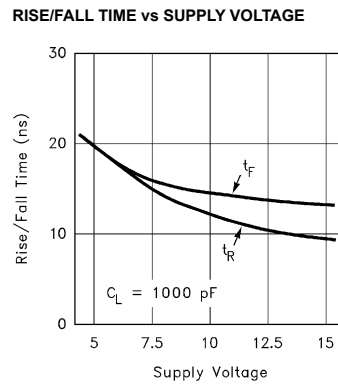
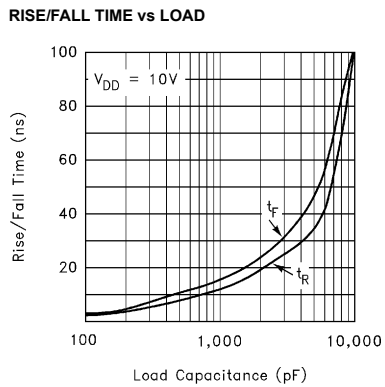

EL7212 Macro Model



```

**** EL7212 model ****
*           input
*           |   gnd
*           |   |   Vsupply
*           |   |   |   Vout
*           |   |   |   |
.subckt M7212 2 3 6 7
V1 12 3 1.6
R1 13 15 1k
R2 14 15 5k
R5 11 12 100
C1 15 3 43.3 pF
D1 14 13 dmod
X1 13 11 2 3 comp1
X2 16 12 15 3 comp1
sp 6 7 16 3 spmod
sn 7 3 16 3 snmod
g1 11 0 13 0 938µ
.model dmod d
.model spmod vswitch ron3 roff2meg von1 voff1.5
.model snmod vswitch ron4 roff2meg von3 voff2
.ends M7212
.subckt comp1 out inp inm vss
e1 out vss table { (v(inp) v(inm))* 5000} (0,0) (3.2,3.2)
Rout out vss 10meg
Rinp inp vss 10meg
Rinm inm vss 10meg
.ends comp1
    
```

Revision History

The revision history provided is for informational purposes only and is believed to be accurate, but not warranted. Please visit our website to make sure you have the latest revision.

DATE	REVISION	CHANGE
Feb 18, 2020	2.01	Updated ordering information table. Added Revision History Replaced POD MDP0031 with E8.3 POD. Replaced POD MDP0027 with M8.15E POD. Updated disclaimer

Package Outline Drawings



NOTES:

1. Controlling Dimensions: INCH. In case of conflict between English and Metric dimensions, the inch dimensions control.
2. Dimensioning and tolerancing per ANSI Y14.5M-1982.
3. Symbols are defined in the "MO Series Symbol List" in Section 2.2 of Publication No. 95.
4. Dimensions A, A1 and L are measured with the package seated in JEDEC seating plane gauge GS-3.
5. D, D1, and E1 dimensions do not include mold flash or protrusions. Mold flash or protrusions shall not exceed 0.010 inch (0.25mm).
6. E and e_A are measured with the leads constrained to be perpendicular to datum -C-.
7. e_B and e_C are measured at the lead tips with the leads unconstrained. e_C must be zero or greater.
8. B1 maximum dimensions do not include dambar protrusions. Dambar protrusions shall not exceed 0.010 inch (0.25mm).
9. N is the maximum number of terminal positions.
10. Corner leads (1, N, N/2 and N/2 + 1) for E8.3, E16.3, E18.3, E28.3, E42.6 will have a B1 dimension of 0.030 - 0.045 inch (0.76 - 1.14mm).

**E8.3 (JEDEC MS-001-BA ISSUE D)
8 LEAD DUAL-IN-LINE PLASTIC PACKAGE (PDIP)**

SYMBOL	INCHES		MILLIMETERS		NOTES
	MIN	MAX	MIN	MAX	
A	-	0.210	-	5.33	4
A1	0.015	-	0.39	-	4
A2	0.115	0.195	2.93	4.95	-
B	0.014	0.022	0.356	0.558	-
B1	0.045	0.070	1.15	1.77	8, 10
C	0.008	0.014	0.204	0.355	-
D	0.355	0.400	9.01	10.16	5
D1	0.005	-	0.13	-	5
E	0.300	0.325	7.62	8.25	6
E1	0.240	0.280	6.10	7.11	5
e	0.100 BSC		2.54 BSC		-
e _A	0.300 BSC		7.62 BSC		6
e _B	-	0.430	-	10.92	7
L	0.115	0.150	2.93	3.81	4
N	8		8		9

Rev. 0 12/93

M8.15E
 8 LEAD NARROW BODY SMALL OUTLINE PLASTIC PACKAGE
 Rev 0, 08/09

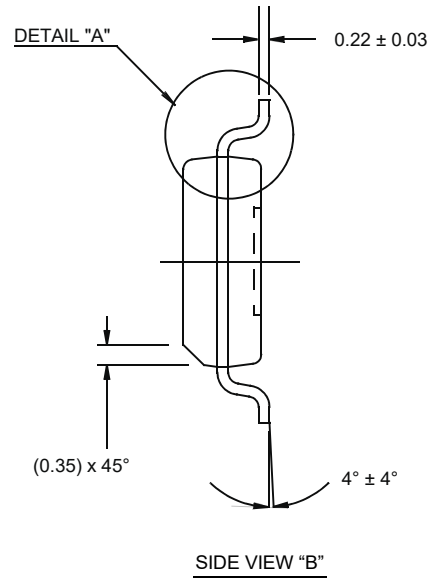
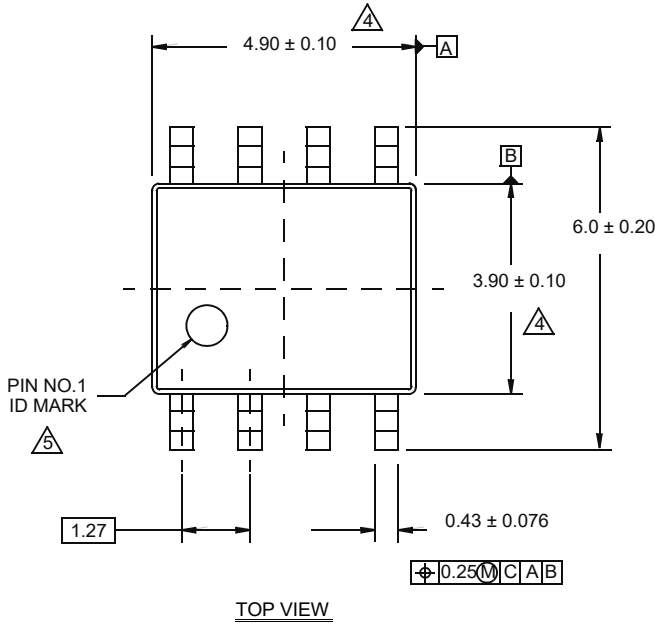

- NOTES:
1. Dimensions are in millimeters.
Dimensions in () for Reference Only.
 2. Dimensioning and tolerancing conform to AMSE Y14.5m-1994.
 3. Unless otherwise specified, tolerance : Decimal ± 0.05
 4. Dimension does not include interlead flash or protrusions.
Interlead flash or protrusions shall not exceed 0.25mm per side.
 5. The pin #1 identifier may be either a mold or mark feature.
 6. Reference to JEDEC MS-012.

Notice

1. Descriptions of circuits, software and other related information in this document are provided only to illustrate the operation of semiconductor products and application examples. You are fully responsible for the incorporation or any other use of the circuits, software, and information in the design of your product or system. Renesas Electronics disclaims any and all liability for any losses and damages incurred by you or third parties arising from the use of these circuits, software, or information.
 2. Renesas Electronics hereby expressly disclaims any warranties against and liability for infringement or any other claims involving patents, copyrights, or other intellectual property rights of third parties, by or arising from the use of Renesas Electronics products or technical information described in this document, including but not limited to, the product data, drawings, charts, programs, algorithms, and application examples.
 3. No license, express, implied or otherwise, is granted hereby under any patents, copyrights or other intellectual property rights of Renesas Electronics or others.
 4. You shall not alter, modify, copy, or reverse engineer any Renesas Electronics product, whether in whole or in part. Renesas Electronics disclaims any and all liability for any losses or damages incurred by you or third parties arising from such alteration, modification, copying or reverse engineering.
 5. Renesas Electronics products are classified according to the following two quality grades: "Standard" and "High Quality". The intended applications for each Renesas Electronics product depends on the product's quality grade, as indicated below.
 - "Standard": Computers; office equipment; communications equipment; test and measurement equipment; audio and visual equipment; home electronic appliances; machine tools; personal electronic equipment; industrial robots; etc.
 - "High Quality": Transportation equipment (automobiles, trains, ships, etc.); traffic control (traffic lights); large-scale communication equipment; key financial terminal systems; safety control equipment; etc.Unless expressly designated as a high reliability product or a product for harsh environments in a Renesas Electronics data sheet or other Renesas Electronics document, Renesas Electronics products are not intended or authorized for use in products or systems that may pose a direct threat to human life or bodily injury (artificial life support devices or systems; surgical implantations; etc.), or may cause serious property damage (space system; undersea repeaters; nuclear power control systems; aircraft control systems; key plant systems; military equipment; etc.). Renesas Electronics disclaims any and all liability for any damages or losses incurred by you or any third parties arising from the use of any Renesas Electronics product that is inconsistent with any Renesas Electronics data sheet, user's manual or other Renesas Electronics document.
 6. When using Renesas Electronics products, refer to the latest product information (data sheets, user's manuals, application notes, "General Notes for Handling and Using Semiconductor Devices" in the reliability handbook, etc.), and ensure that usage conditions are within the ranges specified by Renesas Electronics with respect to maximum ratings, operating power supply voltage range, heat dissipation characteristics, installation, etc. Renesas Electronics disclaims any and all liability for any malfunctions, failure or accident arising out of the use of Renesas Electronics products outside of such specified ranges.
 7. Although Renesas Electronics endeavors to improve the quality and reliability of Renesas Electronics products, semiconductor products have specific characteristics, such as the occurrence of failure at a certain rate and malfunctions under certain use conditions. Unless designated as a high reliability product or a product for harsh environments in a Renesas Electronics data sheet or other Renesas Electronics document, Renesas Electronics products are not subject to radiation resistance design. You are responsible for implementing safety measures to guard against the possibility of bodily injury, injury or damage caused by fire, and/or danger to the public in the event of a failure or malfunction of Renesas Electronics products, such as safety design for hardware and software, including but not limited to redundancy, fire control and malfunction prevention, appropriate treatment for aging degradation or any other appropriate measures. Because the evaluation of microcomputer software alone is very difficult and impractical, you are responsible for evaluating the safety of the final products or systems manufactured by you.
 8. Please contact a Renesas Electronics sales office for details as to environmental matters such as the environmental compatibility of each Renesas Electronics product. You are responsible for carefully and sufficiently investigating applicable laws and regulations that regulate the inclusion or use of controlled substances, including without limitation, the EU RoHS Directive, and using Renesas Electronics products in compliance with all these applicable laws and regulations. Renesas Electronics disclaims any and all liability for damages or losses occurring as a result of your noncompliance with applicable laws and regulations.
 9. Renesas Electronics products and technologies shall not be used for or incorporated into any products or systems whose manufacture, use, or sale is prohibited under any applicable domestic or foreign laws or regulations. You shall comply with any applicable export control laws and regulations promulgated and administered by the governments of any countries asserting jurisdiction over the parties or transactions.
 10. It is the responsibility of the buyer or distributor of Renesas Electronics products, or any other party who distributes, disposes of, or otherwise sells or transfers the product to a third party, to notify such third party in advance of the contents and conditions set forth in this document.
 11. This document shall not be reprinted, reproduced or duplicated in any form, in whole or in part, without prior written consent of Renesas Electronics.
 12. Please contact a Renesas Electronics sales office if you have any questions regarding the information contained in this document or Renesas Electronics products.
- (Note1) "Renesas Electronics" as used in this document means Renesas Electronics Corporation and also includes its directly or indirectly controlled subsidiaries.
- (Note2) "Renesas Electronics product(s)" means any product developed or manufactured by or for Renesas Electronics.

(Rev.4.0-1 November 2017)

Corporate Headquarters

TOYOSU FORESIA, 3-2-24 Toyosu,
Koto-ku, Tokyo 135-0061, Japan
www.renesas.com

Contact Information

For further information on a product, technology, the most up-to-date version of a document, or your nearest sales office, please visit:
www.renesas.com/contact/

Trademarks

Renesas and the Renesas logo are trademarks of Renesas Electronics Corporation. All trademarks and registered trademarks are the property of their respective owners.

Данный компонент на территории Российской Федерации

Вы можете приобрести в компании MosChip.

Для оперативного оформления запроса Вам необходимо перейти по данной ссылке:

<http://moschip.ru/get-element>

Вы можете разместить у нас заказ для любого Вашего проекта, будь то серийное производство или разработка единичного прибора.

В нашем ассортименте представлены ведущие мировые производители активных и пассивных электронных компонентов.

Нашей специализацией является поставка электронной компонентной базы двойного назначения, продукции таких производителей как XILINX, Intel (ex.ALTERA), Vicor, Microchip, Texas Instruments, Analog Devices, Mini-Circuits, Amphenol, Glenair.

Сотрудничество с глобальными дистрибьюторами электронных компонентов, предоставляет возможность заказывать и получать с международных складов практически любой перечень компонентов в оптимальные для Вас сроки.

На всех этапах разработки и производства наши партнеры могут получить квалифицированную поддержку опытных инженеров.

Система менеджмента качества компании отвечает требованиям в соответствии с ГОСТ Р ИСО 9001, ГОСТ РВ 0015-002 и ЭС РД 009

Офис по работе с юридическими лицами:

105318, г.Москва, ул.Щербаковская д.3, офис 1107, 1118, ДЦ «Щербаковский»

Телефон: +7 495 668-12-70 (многоканальный)

Факс: +7 495 668-12-70 (доб.304)

E-mail: info@moschip.ru

Skype отдела продаж:

moschip.ru

moschip.ru_4

moschip.ru_6

moschip.ru_9