

### Features

- 3W Output at 10% THD with a 4Ω Load and 5V Supply
- Supply Voltage from 2.5V to 5.5 V
- Efficiency Up to 89%
- Superior Low Noise without Input
- Few External Components to Save the Space and Cost
- Short Circuit Protection
- Thermal Shutdown
- Space Saving Packages :  
2mm X 2mm WCSP  
4mm X 4mm Thin QFN
- Pb-Free Packages

### Applications

- LCD Monitor / TV Projector
- Notebook Computers
- Portable Speakers
- Portable DVD Players, Game Machines
- Cellular Phones/Speaker Phones

### Description

The PAM8404 is a 3W high efficiency filterless class-D audio amplifier in 4mmX4mm QFN and 2mmX2mm wafer chip scale (WCSP) packages that requires few external components.

Features like 89% efficiency, -63dB PSRR, improved RF-rectification immunity, and very small PCB area make the PAM8404 class-D amplifier ideal for cellular handset and PDA applications.

In cellular handsets, the earpiece, speaker phone, and melody ringer can each be driven by the PAM8404. The PAM8404 allows independent gain by summing signals from separate sources, and has as low as 43μV A-weighted noise floor.

PAM8404 is available in QFN 4mmx4mm and WCSP 2mmx2mm packages.

### Typical Application Circuit

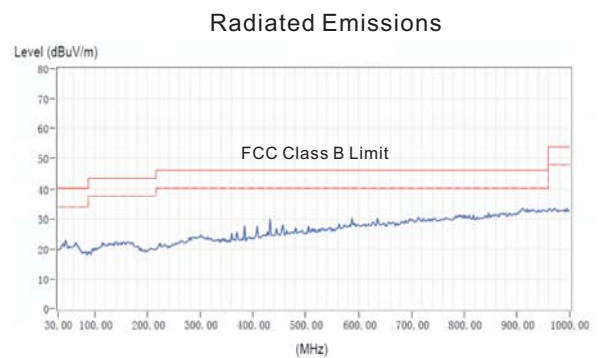
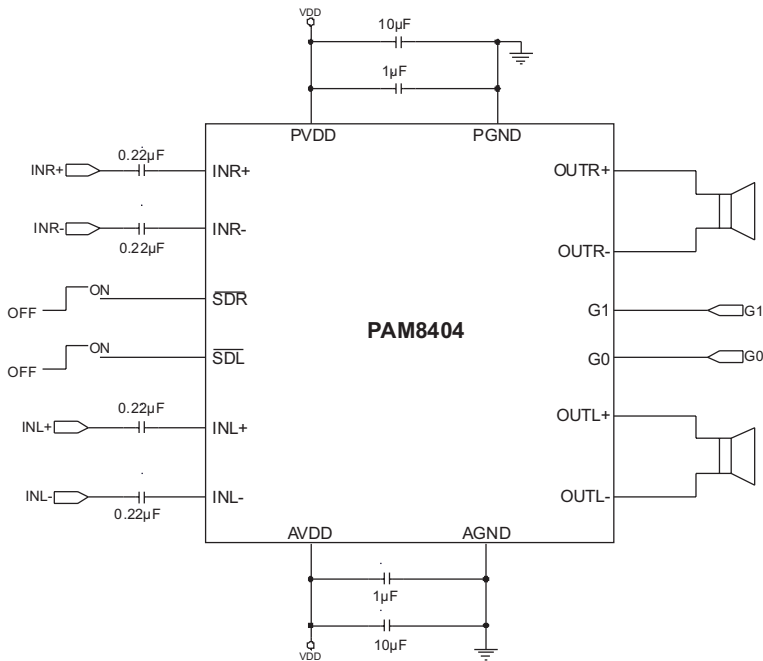

### Block Diagram

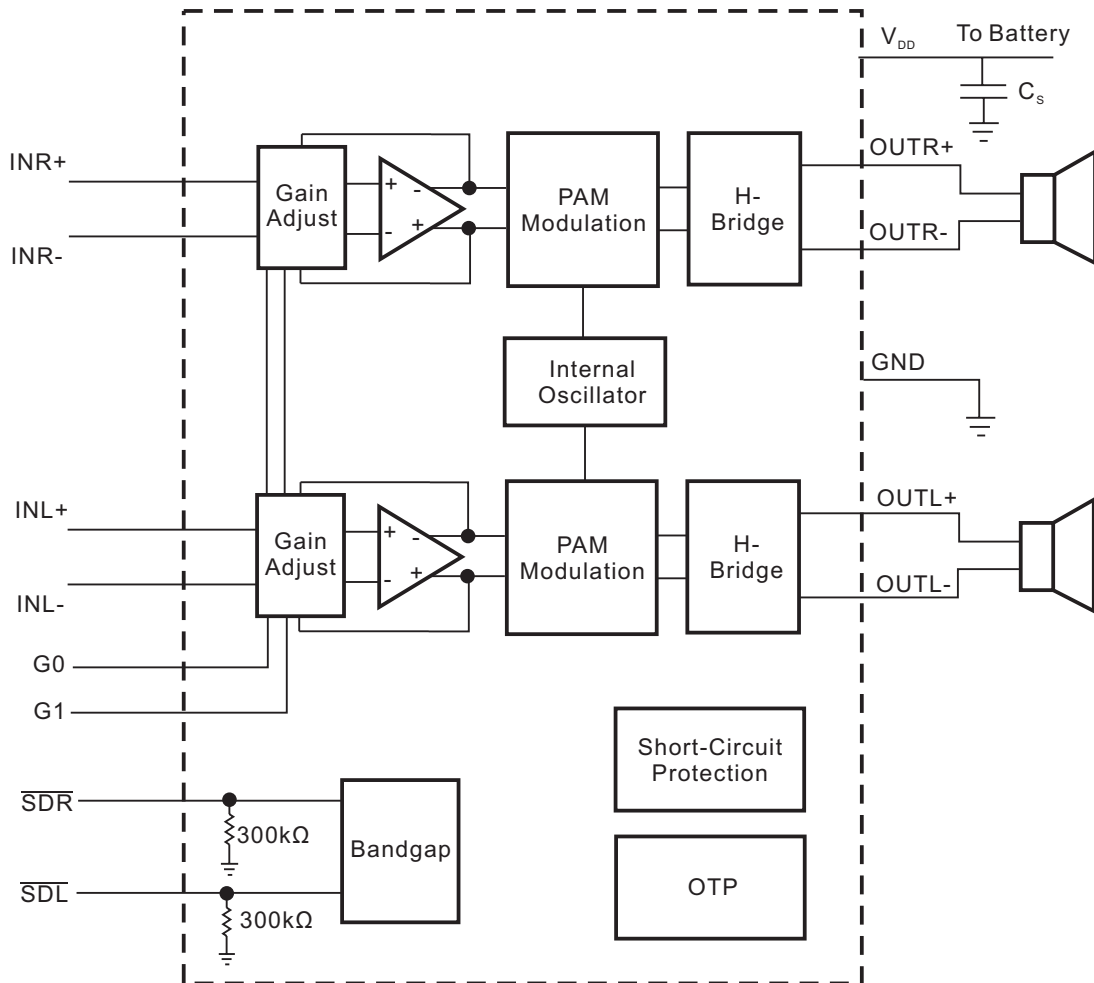

### Pin Configuration & Marking Information

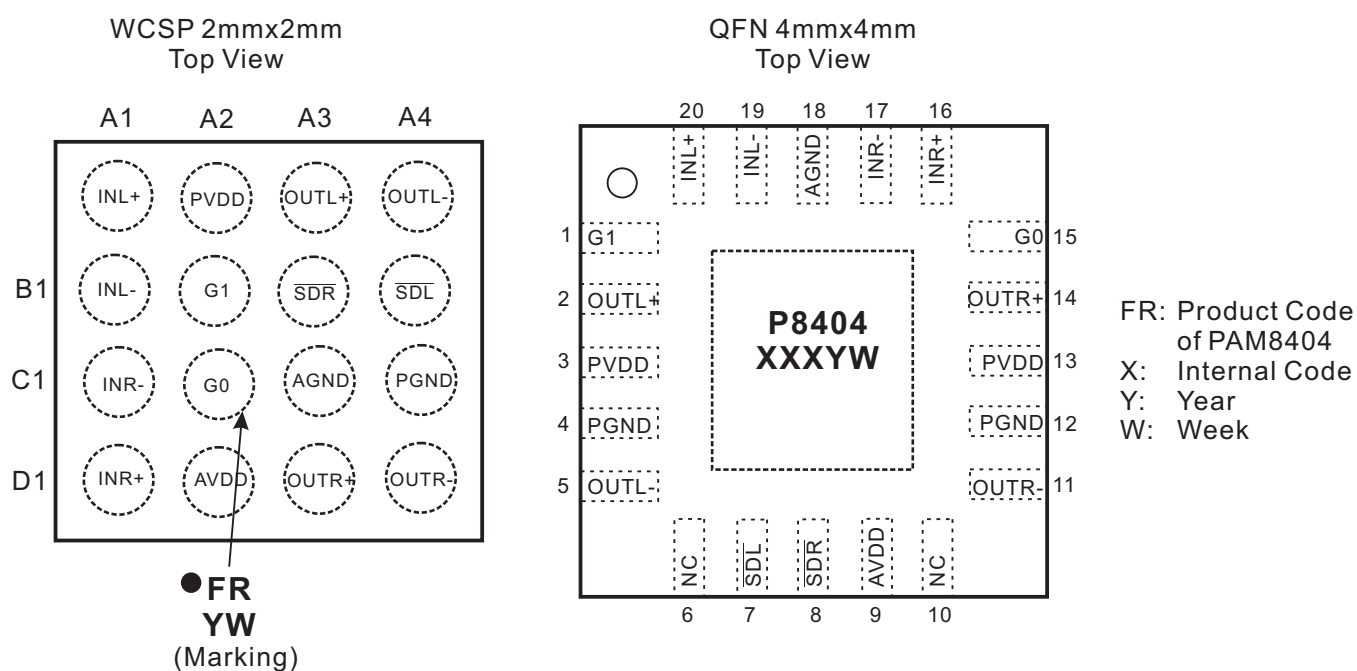

### Pin Descriptions

Name	Pin Number		Description
G1	1	B2	Gain select (MSB)
OUTL+	2	A3	Left channel positive differential output
PVDD	3,13	A2	Power supply (must be same voltage as AVDD)
PGND	4,12	C4	Power ground
OUTL-	5	A4	Left channel negative differential output
NC	6,10	-	No connect
SDL	7	B4	Left channel shutdown terminal (active low)
SDR	8	B3	Right channel shutdown terminal (active low)
AVDD	9	D2	Analog supply (must be same voltage as PVDD)
OUTR-	11	D4	Right channel negative differential output
OUTR+	14	D3	Right channel positive differential output
G0	15	C2	Gain select (LSB)
INR+	16	D1	Right channel positive input
INR-	17	C1	Right channel negative input
AGND	18	C3	Analog ground
INL-	19	B1	Left channel negative input
INL+	20	A1	Left channel positive input



### Absolute Maximum Ratings

These are stress ratings only and functional operation is not implied. Exposure to absolute maximum ratings for prolonged time periods may affect device reliability. All voltages are with respect to ground.

Supply Voltage .....	6.0V	Maximum Junction Temperature.....	150°C
Input Voltage.....	-0.3V to $V_{DD}+0.3V$	Storage Temperature.....	-65°C to 150°C
		Soldering Temperature.....	250°C, 10 sec

### Recommended Operating Conditions

Supply voltage Range.....	2.5V to 5.5V	Operation Temperature Range.....	-40°C to 85°C
		Junction Temperature Range.....	-40°C to 125°C

### Thermal Information

Parameter	Symbol	Package	Maximum	Unit
Thermal Resistance (Junction to Ambient)	$\theta_{JA}$	WCSP2x2-16	64	°C/W
		QFN4x4-20	31	
Thermal Resistance (Junction to Case)	$\theta_{JC}$	WCSP2x2-16	-	°C/W
		QFN4x4-20	13	



### Electrical Characteristic

QFN 4x4 20-Pin

$T_A=25^{\circ}\text{C}$ ,  $AVDD=PVDD=5\text{V}$ ,  $GND=PGND=0\text{V}$ , unless otherwise noted.

Parameter	Symbol	Test Conditions	MIN	TYP	MAX	UNIT
Supply Voltage	$V_{DD}$		2.5		5.5	V
Output Power	$P_o$	THD+N=10% f=1kHz $R_L=4\Omega$	$V_{DD}=5\text{V}$	3		W
			$V_{DD}=3.6\text{V}$	1.5		
		THD+N=1% f=1kHz $R_L=4\Omega$	$V_{DD}=5\text{V}$	2.35		W
			$V_{DD}=3.6\text{V}$	1.2		
		THD+N=10% f=1kHz $R_L=8\Omega$	$V_{DD}=5\text{V}$	1.7		W
			$V_{DD}=3.6\text{V}$	0.9		
THD+N=1% f=1kHz $R_L=8\Omega$	$V_{DD}=5\text{V}$	1.4		W		
	$V_{DD}=3.6\text{V}$	0.7				
Total Harmonic Distortion Plus Noise	THD+N	$V_{DD}=5.0\text{V}, P_o=0.5\text{W}, R_L=8\Omega$	f=1kHz	0.15		%
		$V_{DD}=3.6\text{V}, P_o=0.5\text{W}, R_L=8\Omega$		0.27		
		$V_{DD}=5.0\text{V}, P_o=1\text{W}, R_L=4\Omega$	f=1kHz	0.23		%
		$V_{DD}=3.6\text{V}, P_o=1\text{W}, R_L=4\Omega$		0.24		
Power Supply Ripple Rejection	PSRR	$V_{DD}=5.0\text{V}$ , Inputs ac-grounded with $C_{in}=1\mu\text{F}$	f=100Hz	-48		dB
			f=1kHz	-63		
Crosstalk	$C_s$	$V_{DD}=5\text{V}, P_o=0.5\text{W}, R_L=4\Omega, G_v=23\text{dB}$	F=1kHz	-93		dB
Signal-to-noise ratio	SNR	$V_{DD}=5\text{V}$ , $V_{rms}=1\text{V}, G_v=23\text{dB}$	A-weighting	87		dB
Output noise	$V_n$	$V_{DD}=5\text{V}$ , Inputs ac-grounded with $C_{in}=1\mu\text{F}$	A-weighting	43		$\mu\text{V}$
			BW 22Hz-22kHz No A-weighting	59		
Dynamic range	Dyn	$V_{DD}=5.0\text{V}$ , THD=1%	A-weighting	97		dB
Efficiency	$\eta$	$R_L=8\Omega$ , THD=10%	f=1kHz	89		%
		$R_L=4\Omega$ , THD=10%		84		
Quiescent Current	$I_Q$	$V_{DD}=5\text{V}$	No load	11		mA
		$V_{DD}=3.6\text{V}$		6		
Shutdown Current	$I_{SD}$	$V_{DD}=5.5\text{V}$	$V_{sd}=0.3\text{V}$	< 1		$\mu\text{A}$
Static Drain-to-source On-state Resistor	$R_{dson}$	$I_{DS}=500\text{mA}, V_{gs}=5\text{V}$	PMOS	250		m $\Omega$
			NMOS	170		
Switching Frequency	fsw	$V_{DD}=3\text{V to }5\text{V}$		300		kHz
Output Offset Voltage	$V_{os}$	$V_{in}=0\text{V}, V_{DD}=5\text{V}$		10		mV
closed-loop voltage gain	Gain	$V_{DD}=5\text{V}, R_L=4\Omega, f=1\text{kHz}$	G0=L G1=L	6		dB
			G0=H G1=L	12		
			G0=L G1=H	18		
			G0=H G1=H	24		
Over Temperature Protection	OTP	No Load, Junction Temperature		150		$^{\circ}\text{C}$
Over Temperature Hysteresis	OTH			50		



### Electrical Characteristic

#### WCSP 2x2-16

$T_A=25^{\circ}\text{C}$ ,  $AVDD=PVDD=5\text{V}$ ,  $GND=PGND=0\text{V}$ , unless otherwise noted.

Parameter	Symbol	Test Conditions	MIN	TYP	MAX	UNIT
Supply Voltage	$V_{DD}$		2.5		5.5	V
Output Power	$P_o$	THD+N=10% f=1kHz $R_L=4\Omega$	$V_{DD}=5\text{V}$	2.2		W
			$V_{DD}=3.6\text{V}$	1.2		
		THD+N=1% f=1kHz $R_L=4\Omega$	$V_{DD}=5\text{V}$	1.8		W
			$V_{DD}=3.6\text{V}$	1		
		THD+N=10% f=1kHz $R_L=8\Omega$	$V_{DD}=5\text{V}$	1.5		W
			$V_{DD}=3.6\text{V}$	0.8		
		THD+N=1% f=1kHz $R_L=8\Omega$	$V_{DD}=5\text{V}$	1.2		W
			$V_{DD}=3.6\text{V}$	0.6		
Total Harmonic Distortion Plus Noise	THD+N	$V_{DD}=5.0\text{V}, P_o=0.5\text{W}, R_L=8\Omega$	f=1kHz	0.3		%
		$V_{DD}=3.6\text{V}, P_o=0.5\text{W}, R_L=8\Omega$		0.4		
		$V_{DD}=5.0\text{V}, P_o=1\text{W}, R_L=4\Omega$	f=1kHz	0.3		%
		$V_{DD}=3.6\text{V}, P_o=1\text{W}, R_L=4\Omega$		0.2		
Power Supply Ripple Rejection	PSRR	$V_{DD}=5.0\text{V}$ , Inputs ac-grounded with $C_{in}=1\mu\text{F}$	f=217Hz	-50		dB
Crosstalk	$C_s$	$V_{DD}=5\text{V}, P_o=0.5\text{W}, R_L=4\Omega, G_v=23\text{dB}$	f=1kHz	-70		dB
Signal-to-noise ratio	SNR	$V_{DD}=5\text{V}$ , $V_{rms}=1\text{V}, G_v=23\text{dB}$	A-weighting	85		dB
Output noise	$V_n$	$V_{DD}=5\text{V}$ , Inputs ac-grounded with $C_{in}=1\mu\text{F}$	A-weighting	34		$\mu\text{V}$
		BW 22Hz-22kHz	No A-weighting	54		
Dynamic range	Dyn	$V_{DD}=5.0\text{V}$ , THD=1%	A-weighting	98		dB
Efficiency	$\eta$	$R_L=8\Omega$ , THD=10%	f=1kHz	85		%
		$R_L=4\Omega$ , THD=10%		75		
Quiescent Current	$I_Q$	$V_{DD}=5\text{V}$	No load	12		mA
		$V_{DD}=3.6\text{V}$		7		
Shutdown Current	$I_{SD}$	$V_{DD}=2.5\text{V to }5.5\text{V}$	$V_{sd}=0.3\text{V}$	< 1		$\mu\text{A}$
Static Drain-to-source On-state Resistor	$R_{dson}$	$I_{DS}=500\text{mA}, V_{GS}=5\text{V}$	PMOS	500		m $\Omega$
			NMOS	460		
Switching Frequency	fsw	$V_{DD}=5\text{V}$		300		kHz
Output Offset Voltage	$V_{os}$	$V_{in}=0\text{V}, V_{DD}=5\text{V}$		20		mV
closed-loop voltage gain	Gain	$V_{DD}=5\text{V}, R_L=4\Omega, f=1\text{kHz}$	$G_0=L, G_1=L$	6		dB
			$G_0=H, G_1=L$	12		
			$G_0=L, G_1=H$	18		
			$G_0=H, G_1=H$	24		
Over Temperature Protection	OTP	No Load, Junction Temperature		150		$^{\circ}\text{C}$
Over Temperature Hysterisis	OTH			50		

### Typical Operating Characteristics ( $T_A=25^\circ\text{C}$ )

#### QFN 4x4 20-Pin

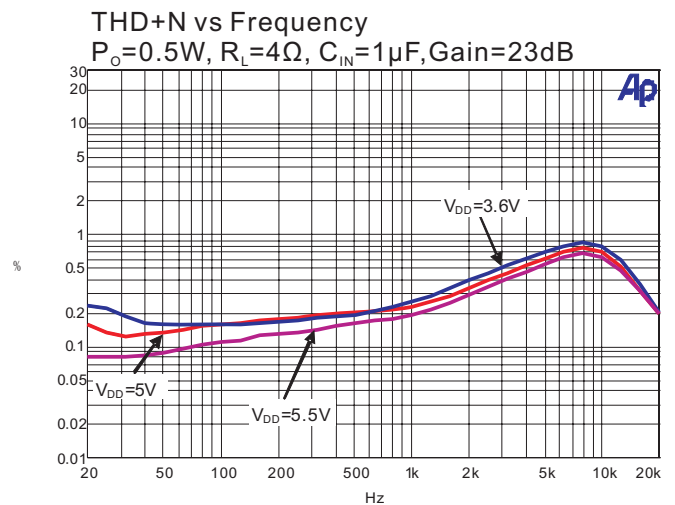
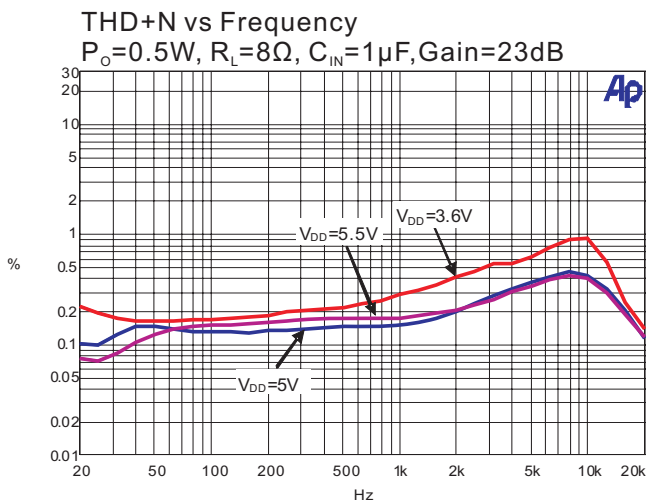
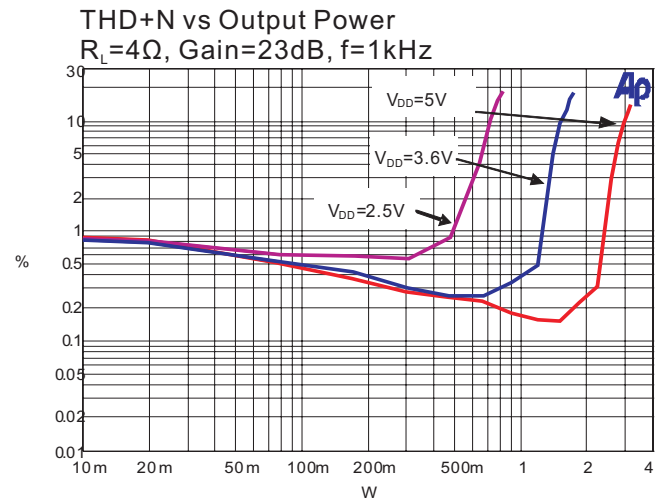
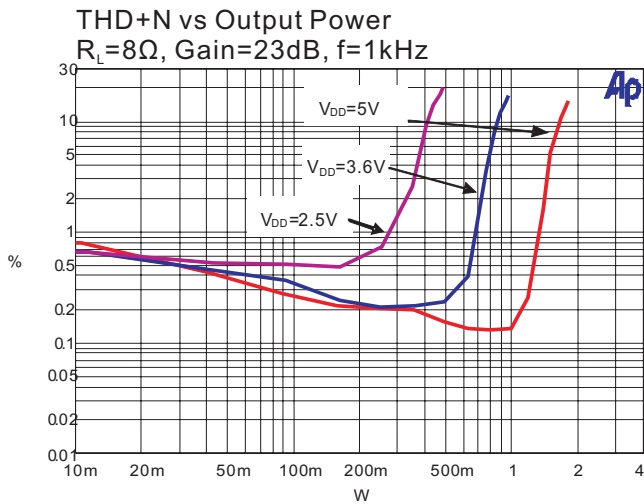
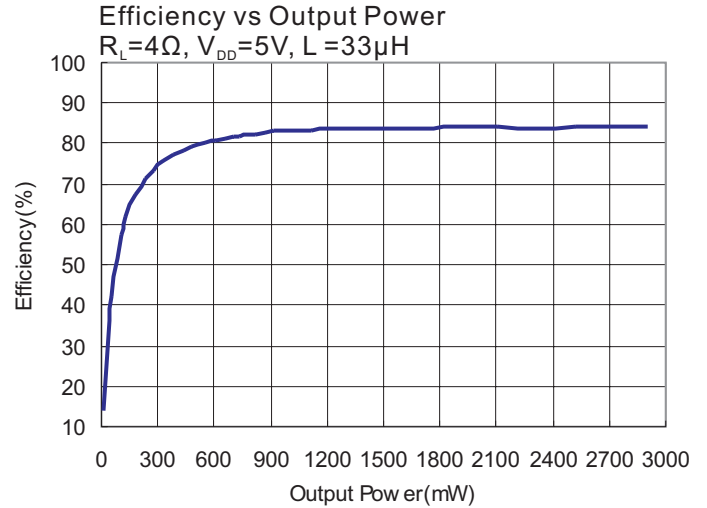
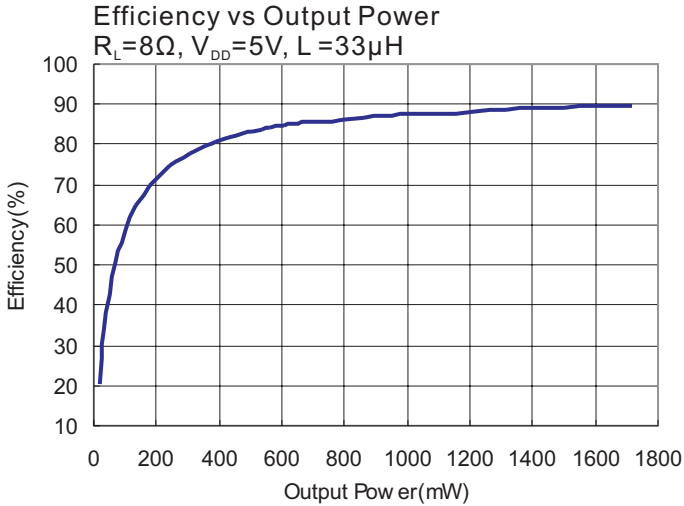

### Typical Operating Characteristics ( $T_A=25^\circ\text{C}$ )

#### QFN 4x4 20-Pin

**THD+N vs Frequency**  
 $V_{DD}=5\text{V}$ ,  $R_L=8\Omega$ ,  $C_{IN}=1\mu\text{F}$ , Gain=23dB

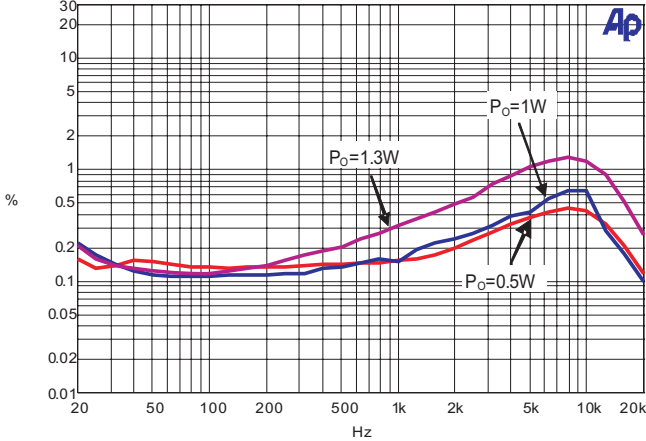

**THD+N vs Frequency**  
 $V_{DD}=5\text{V}$ ,  $R_L=4\Omega$ ,  $C_{IN}=1\mu\text{F}$ , Gain=23dB

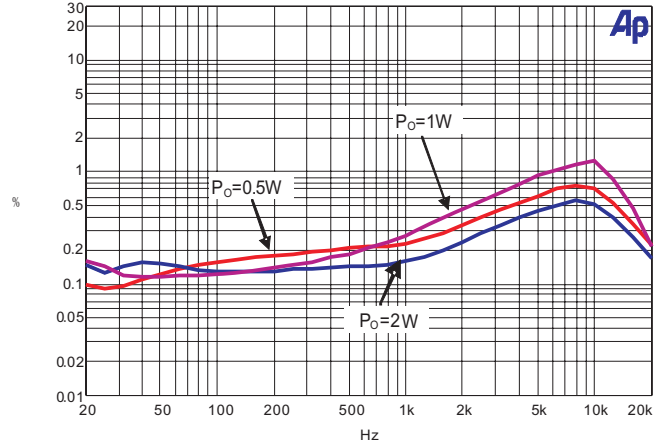

**Frequency Response**  
 $V_{DD}=5\text{V}$ ,  $R_L=4\Omega$ ,  $C_{IN}=1\mu\text{F}$

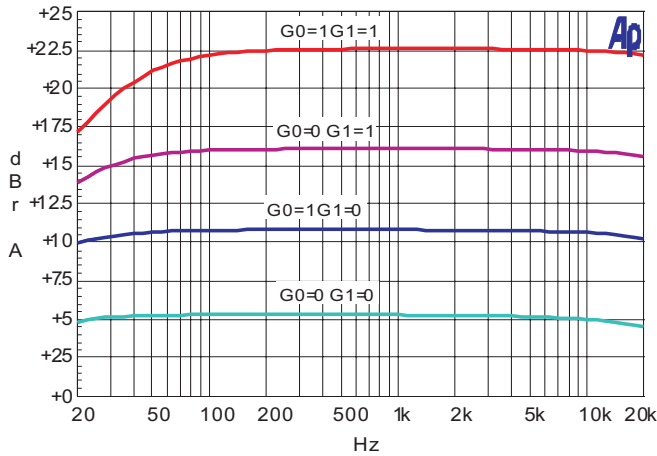

**PSSR vs Frequency**  
 Input ac-ground,  $V_{DD}=5\text{V}$  200mVpp,  
 $R_L=4\Omega$ ,  $C_{IN}=1\mu\text{F}$ , gain=16dB

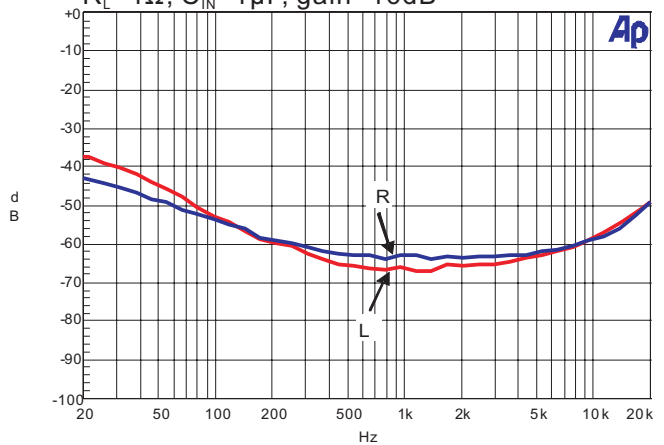

**Crosstalk vs Frequency**  
 $V_{DD}=5\text{V}$ ,  $R_L=4\Omega$ , Gain=23dB

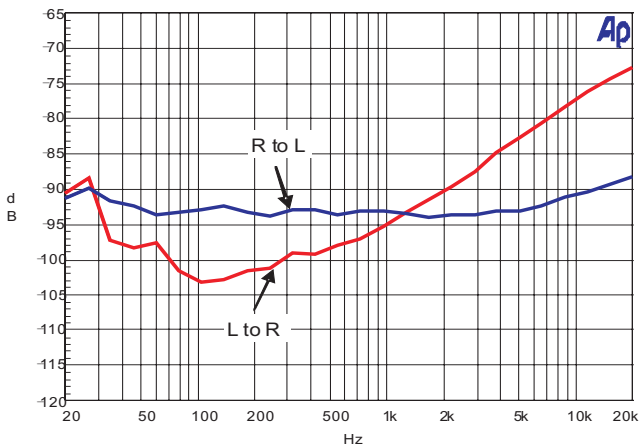

**Noise Floor FFT**  
 Inputs ac-ground,  $V_{DD}=5\text{V}$ ,  $C_{IN}=1\mu\text{F}$ ,  $R_L=4\Omega$ ,  
 Gain=23dB

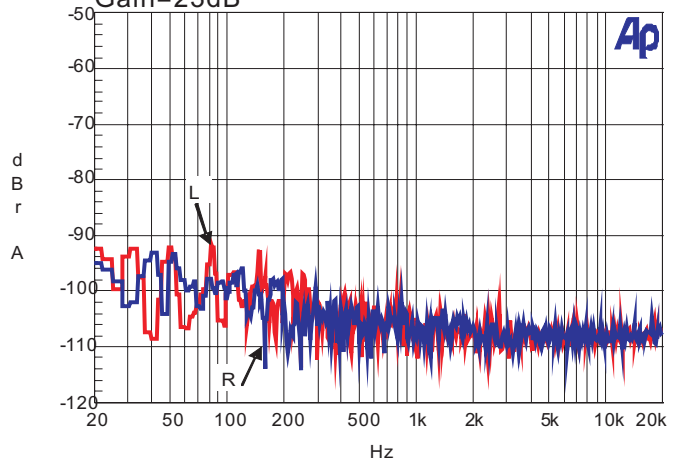



### Typical Operating Characteristics ( $T_A=25^\circ\text{C}$ )

#### QFN 4x4 20-Pin

Quiescent Current vs Supply Voltage  
No Input,  $R_L = \text{No Load}$

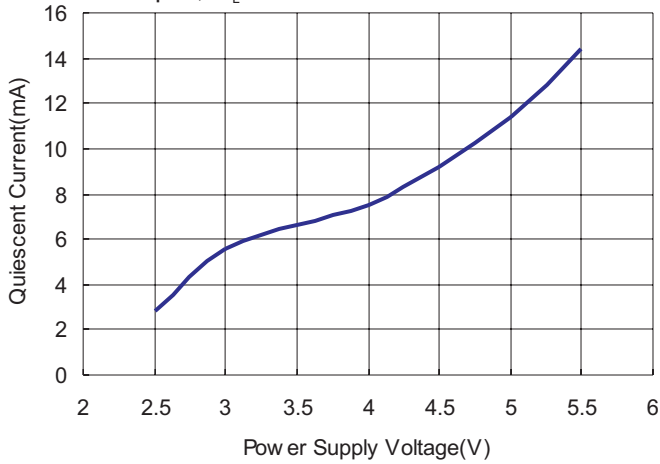

Frequency vs Supply Voltage  
Input ac-ground

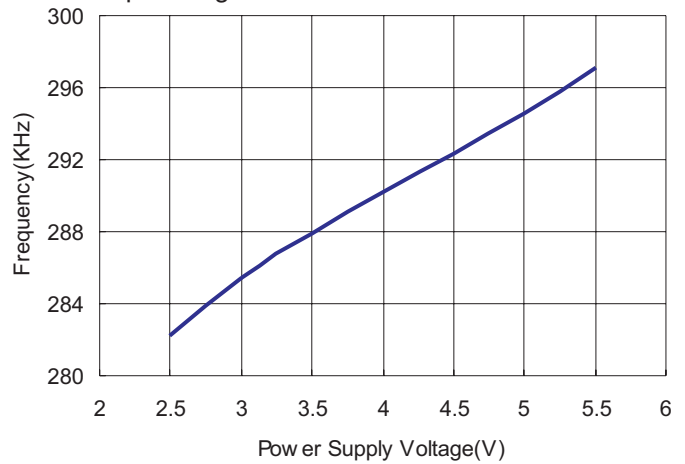

Output Power vs Supply Voltage  
 $C_{IN}=1\mu\text{F}$ ,  $R_L=8\Omega$ , Gain=23dB,  $f=1\text{kHz}$

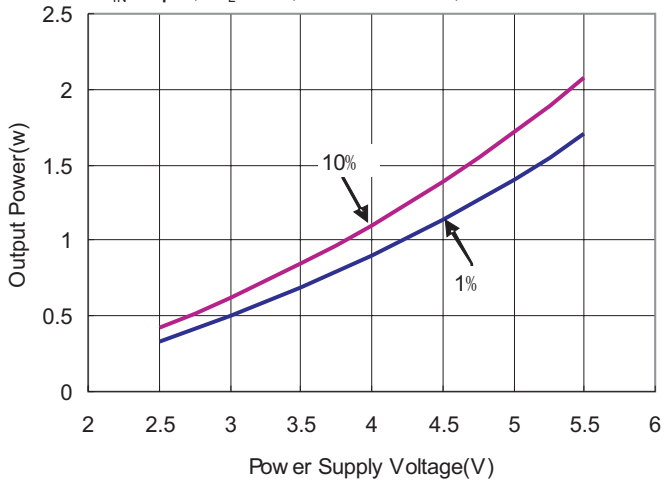

Output Power vs Supply Voltage  
 $C_{IN}=1\mu\text{F}$ ,  $R_L=4\Omega$ , Gain=23dB,  $f=1\text{kHz}$

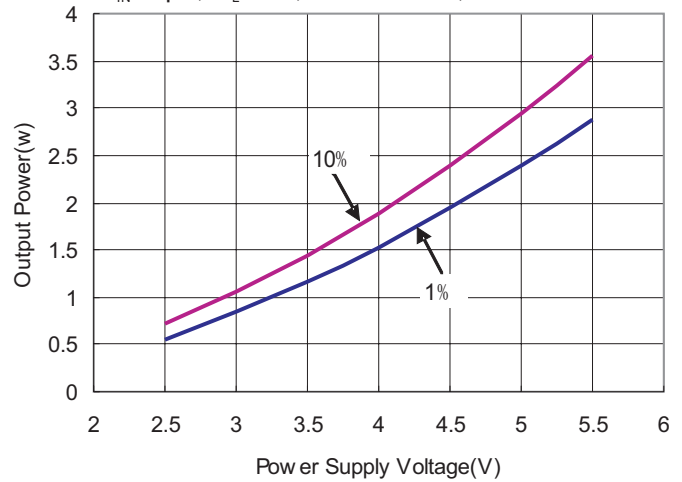

### Typical Operating Characteristics ( $T_A=25^\circ\text{C}$ )

#### WCPS 2x2-16

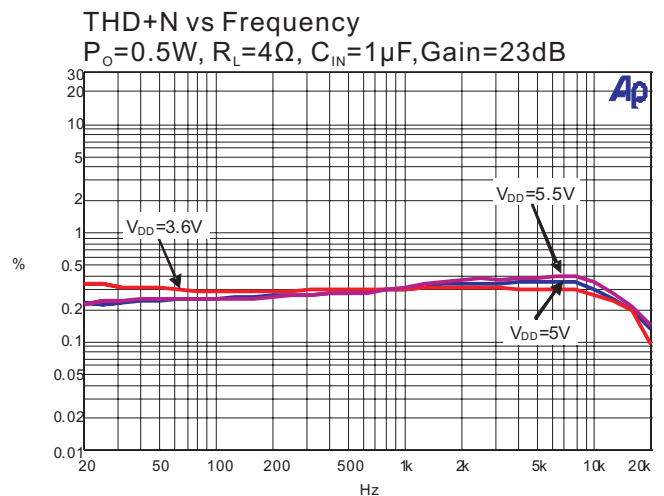
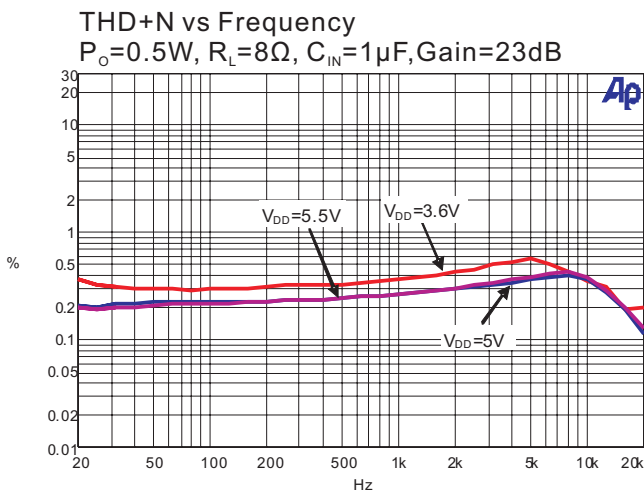
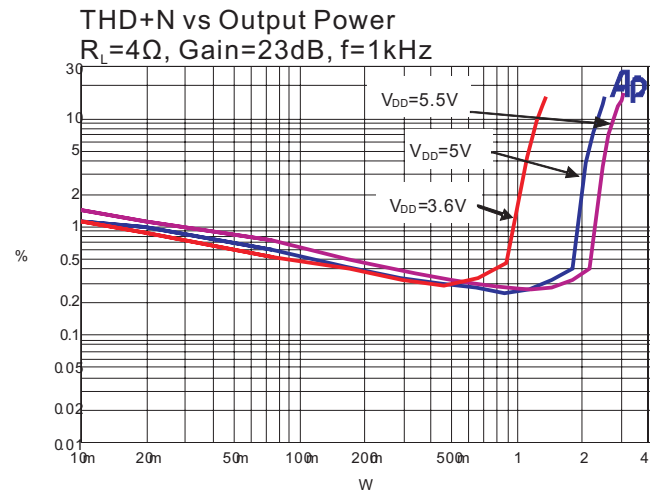
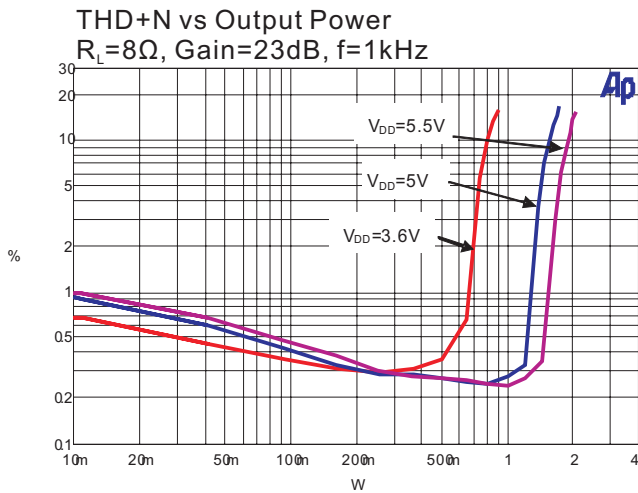
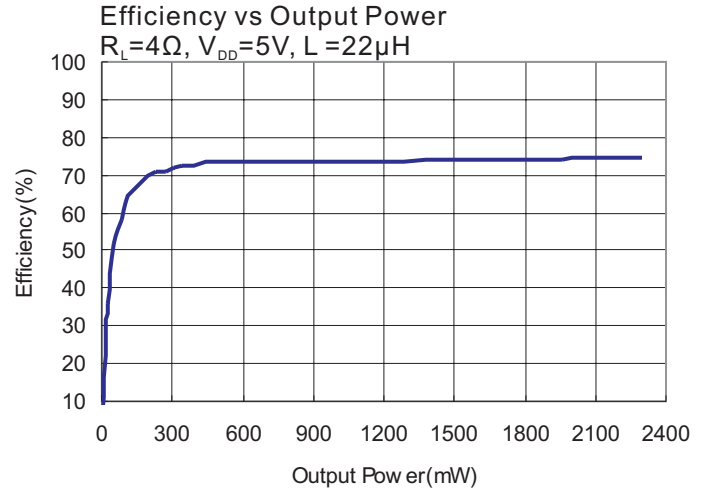
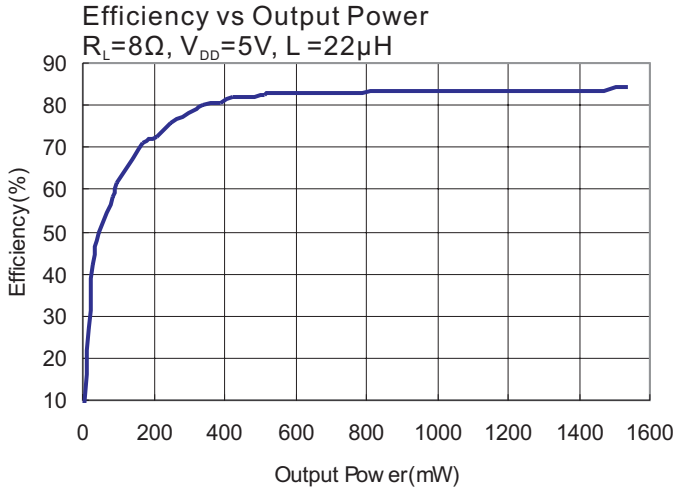

### Typical Operating Characteristics ( $T_A=25^\circ\text{C}$ )

#### WCPS 2x2-16

THD+N vs Frequency  
 $V_{DD}=5\text{V}$ ,  $R_L=8\Omega$ ,  $C_{IN}=1\mu\text{F}$ , Gain=23dB

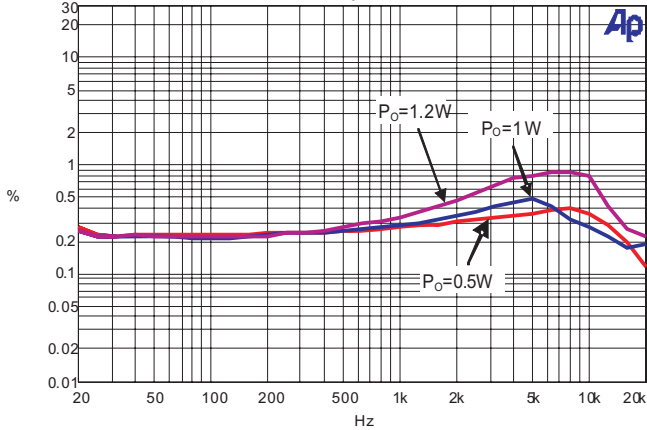

THD+N vs Frequency  
 $V_{DD}=5\text{V}$ ,  $R_L=4\Omega$ ,  $C_{IN}=1\mu\text{F}$ , Gain=23dB

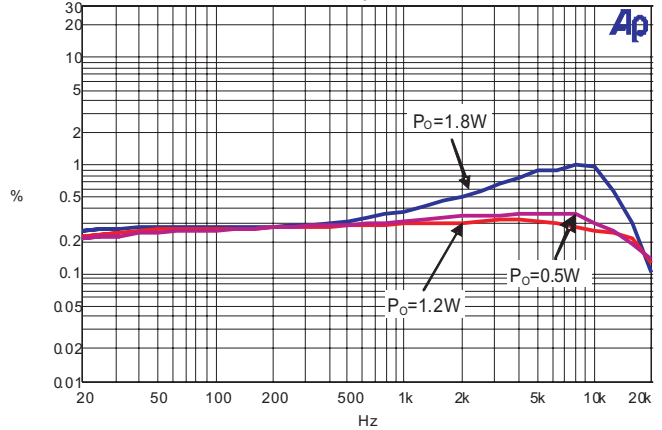

Frequency Response  
 $V_{DD}=5\text{V}$ ,  $R_L=4\Omega$ ,  $C_{IN}=1\mu\text{F}$

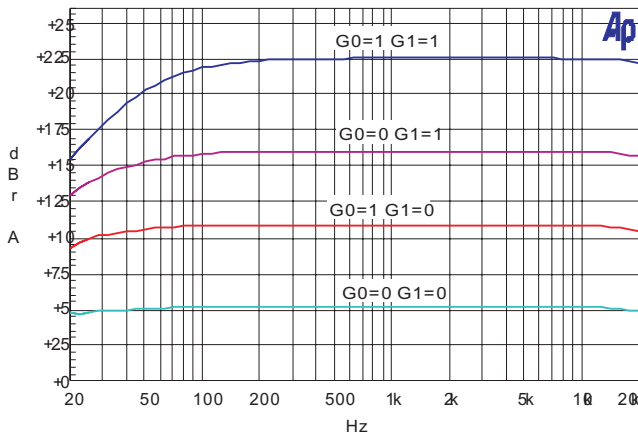

PSSR vs Frequency  
 Input ac-ground,  $V_{DD}=5\text{V}$  200mVpp,  
 $R_L=4\Omega$ ,  $C_{IN}=1\mu\text{F}$ , gain=5dB

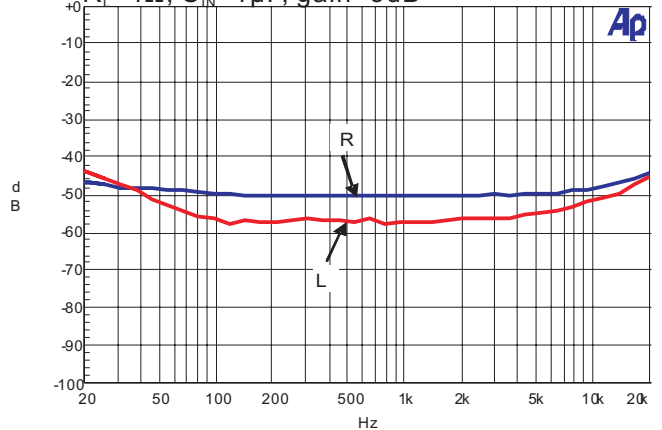

Crosstalk vs Frequency  
 $V_{DD}=5\text{V}$ ,  $R_L=4\Omega$ , Gain=23dB

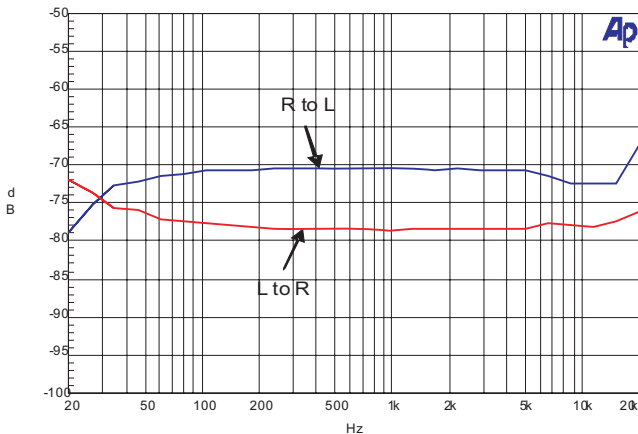

Noise Floor FFT  
 Inputs ac-ground,  $V_{DD}=5\text{V}$ ,  $C_{IN}=1\mu\text{F}$ ,  $R_L=4\Omega$ ,  
 Gain=23dB

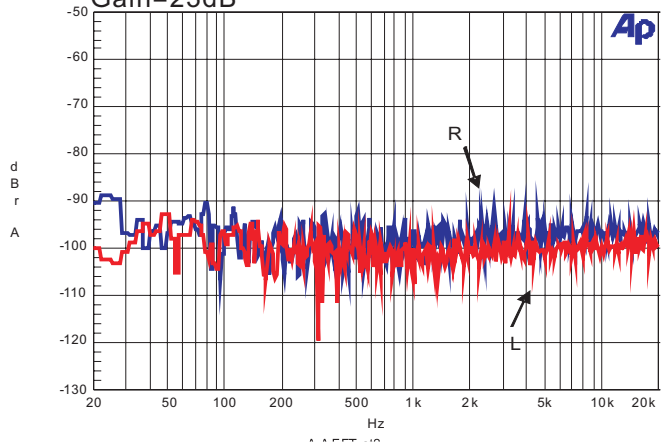

### Typical Operating Characteristics ( $T_A=25^\circ\text{C}$ )

#### WCPS 2x2-16

Quiescent Current vs Supply Voltage  
No Input,  $R_L = \text{No Load}$

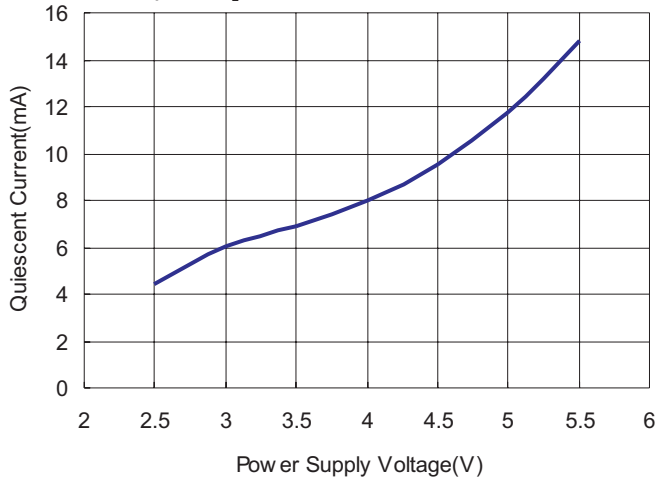

Frequency vs Supply Voltage  
Input ac-ground

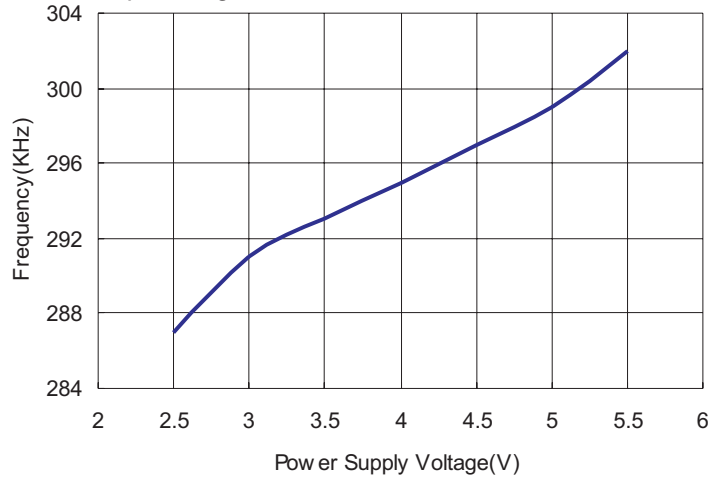

Output Power vs Supply Voltage  
 $C_{IN}=1\mu\text{F}$ ,  $R_L=8\Omega$ , Gain=23dB,  $f=1\text{kHz}$

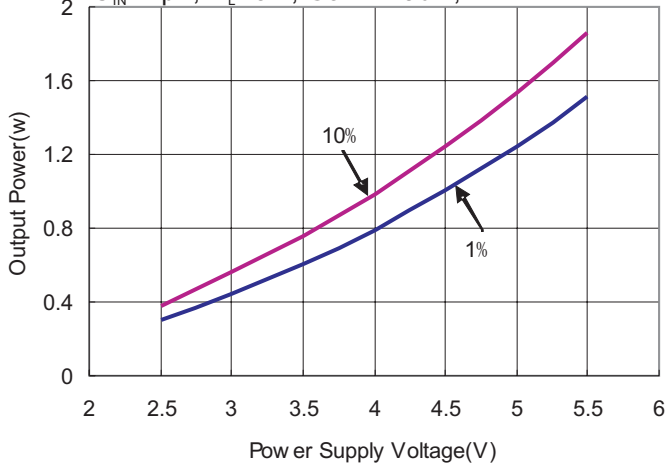

Output Power vs Supply Voltage  
 $C_{IN}=1\mu\text{F}$ ,  $R_L=4\Omega$ , Gain=23dB,  $f=1\text{kHz}$

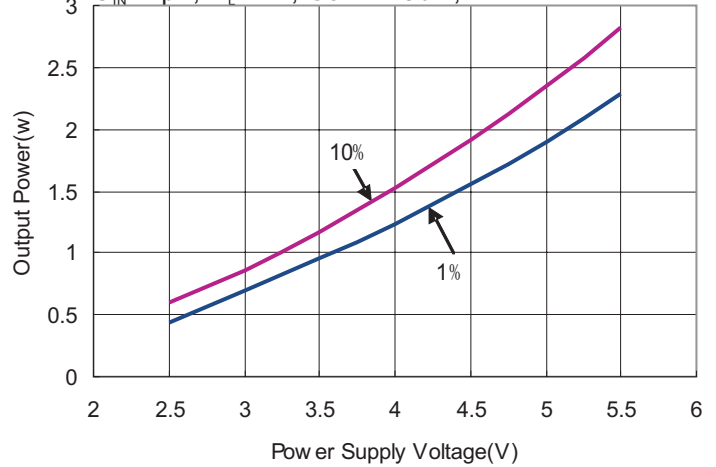

### Test Setup for Performance Testing

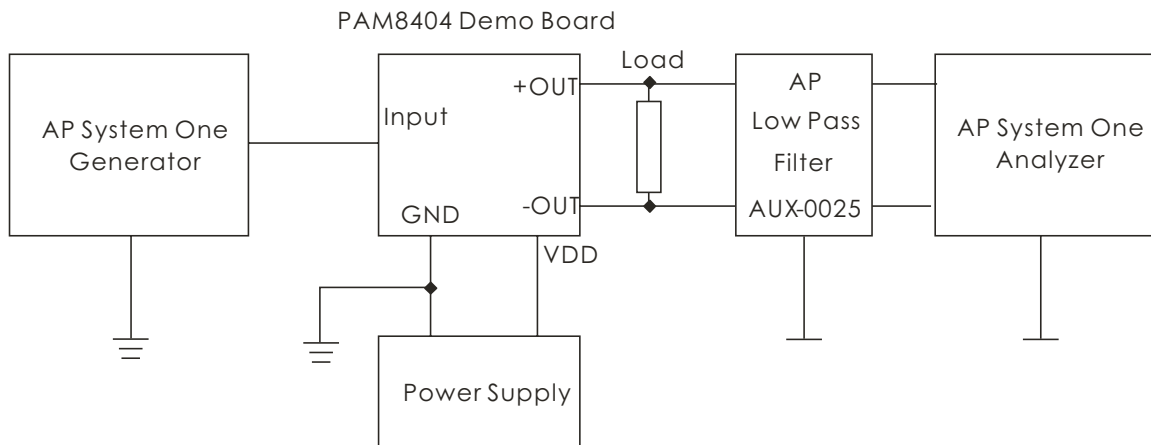

#### Notes

1. The AP AUX-0025 low pass filter is necessary for class-D amplifier measurement with AP analyzer.
2. Two 22 $\mu$ H inductors are used in series with load resistor to emulate the small speaker for efficiency measurement.

### Application Information

#### Gain Setting

The gain of PAM8404 can be selected as 6, 12, 18 or 24 dB utilizing the G0 and G1 gain setting pins. The gains showed in the following table are realized by changing the input resistors inside the amplifier. The input impedance changes with the gain setting.

**Table-1: Gain Setting**

G1	G0	GAIN (V/V)	GAIN (dB)	INPUT IMPEDANCE (kΩ)
0	0	2	6	28.1
0	1	4	12	17.3
1	0	8	18	9.8
1	1	16	24	5.2

For optimal performance the gain should be set to 2x (Ri=150kΩ). Lower gain allows the PAM8404 to operate at its best, and keeps a high voltage at the input making the inputs less susceptible to noise. In addition to these features, lower value of Gain minimizes pop noise.

#### Input Capacitors (Ci)

In the typical application, an input capacitor, Ci, is required to allow the amplifier to bias the input signal to the proper DC level for optimum operation. In this case, Ci and the input impedance Ri form a high-pass filter with the corner frequency determined by the follow equation:

$$f_c = \frac{1}{(2\pi R_i C_i)}$$

It is important to consider the value of Ci as it directly affects the low frequency performance of the circuit. When Ri is 28.1kΩ and the specification calls for a flat bass response are down to 200Hz, the equation is reconfigured as follows:

$$C_i = \frac{1}{(2\pi R_i f_c)}$$

When input resistance variation is considered, the Ci is 28nF, so one would likely choose a value of 33nF. A further consideration for this capacitor is the leakage path from the input source through the input network (Ci, Ri + Rf) to the load. This leakage current creates a DC offset voltage at the input to the amplifier that reduces useful headroom, especially in high gain applications.

For this reason, a low-leakage tantalum or ceramic capacitor is the best choice. When polarized capacitors are used, the positive side of the capacitor should face the amplifier input in most applications as the DC level is held at V<sub>DD</sub>/2, which is likely higher than the source DC level. Please note that it is important to confirm the capacitor polarity in the application.

If the corner frequency is within the audio band, the capacitors should have a tolerance ±10% or better, because any mismatch in capacitance cause an impedance mismatch at the corner frequency and below.

#### Decoupling Capacitor (CS)

The PAM8404 is a high-performance CMOS audio amplifier that requires adequate power supply decoupling to ensure the output total harmonic distortion (THD) as low as possible. Power supply decoupling also prevents the oscillations causing by long lead length between the amplifier and the speaker.

The optimum decoupling is achieved by using two different types of capacitors that target on different types of noise on the power supply leads. For higher frequency transients, spikes, or digital hash on the line, a good low equivalent-series-resistance (ESR) ceramic capacitor, typically 1μF, is placed as close as possible to the device each VDD and PVDD pin for the best operation. For filtering lower frequency noise signals, a large ceramic capacitor of 10μF or greater placed near the audio power amplifier is recommended.

#### How to Reduce EMI

Most applications require a ferrite bead filter for EMI elimination as shown at Figure 1. The ferrite filter reduces EMI of around 1MHz and higher. When selecting a ferrite bead, choose one with high impedance at high frequencies and low impedance at low frequencies.

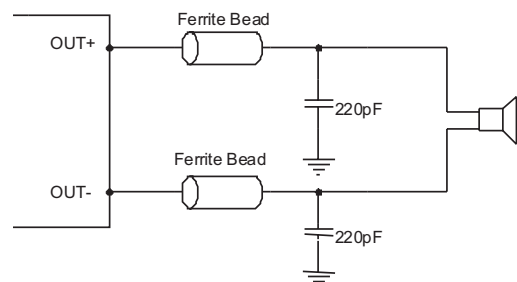

**Figure 1: Ferrite Bead Filter to Reduce EMI**

### Shutdown operation

In order to reduce power consumption while not in use, the PAM8404 contains shutdown circuitry to turn off the amplifier's bias circuitry. It features independent shutdown controls for each channel. This shutdown turns the amplifier off when logic low is placed on the  $\overline{SDx}$  pin. By switching the shutdown pin to GND, the PAM8404 supply current draw will be minimized in idle mode.

### Short Circuit Protection (SCP)

The PAM8404 has short circuit protection circuitry on the outputs to prevent the device from damage when output-to-output shorts or output-to-GND shorts occur. When a short circuit occurs, the device immediately goes into shutdown state. Once the short is removed, the device will be reactivated.

### Over Temperature Protection (OTP)

Thermal protection on the PAM8404 prevents the device from damage when the internal die temperature exceeds 150°C. There is a 15°C tolerance on this trip point from device to device. Once the die temperature exceeds the set point, the device will enter the shutdown state and the outputs are disabled. This is not a latched fault. The thermal fault is cleared once the temperature of the die decreased by 50°C. This large hysteresis will prevent motor boating sound well and the device begins normal operation at this point with no external system interaction.

### POP and Click Circuitry

The PAM8404 contains circuitry to minimize turn-on and turn-off transients or "click and pops", where turn-on refers to either power supply turn-on or device recover from shutdown mode. When the device is turned on, the amplifiers are internally muted. An internal current source ramps up the internal reference voltage. The device will remain in mute mode until the reference voltage reach half supply voltage  $V_{DD}/2$ . As soon as the reference voltage is stable, the device will begin full operation. For the best power-off pop performance, the amplifier should be set in shutdown mode prior to removing the power supply voltage.

### PCB Layout Guidelines

#### Grounding

It is recommended to use plane grounding or separate grounds. Do not use one line connecting power GND and analog GND. Noise currents in the output power stage need to be returned to output noise ground and nowhere else. When these currents circulate elsewhere, they may get into the power supply, or the signal ground, etc, even worse, they may form a loop and radiate noise. Any of these instances results in degraded amplifier performance. The output noise ground that the logical returns for the output noise currents associated with class D switching must tie to system ground at the power exclusively. Signal currents for the inputs, reference need to be returned to quiet ground. This ground only ties to the signal components and the GND pin. GND then ties to system ground.

#### Power Supply Line

Same as the ground, VDD and PVDD need to be separately connected to the system power supply. It is recommended that all the trace could be routed as short and thick as possible. For the power line layout, just imagine water stream, any barricade placed in the trace (shown in figure 2) could result in the bad performance of the amplifier.

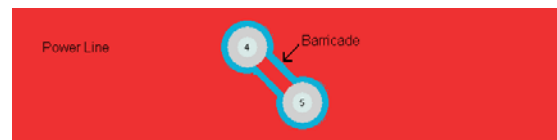

Figure 2: Power Line

#### Components Placement

Decoupling capacitors-As previously described, the high-frequency 1μF decoupling capacitors should be placed as close to the power supply terminals (VDD and PVDD) as possible. Large bulk power supply decoupling capacitors (10μF or greater) should be placed near the PAM8404 on the PVDD terminal.

Input capacitors need to be placed very close to input pins.

Output filter - The ferrite EMI filter should be placed as close to the output terminals as possible for the best EMI performance, and the capacitors used in the filters should be grounded to system ground.

### Ordering Information

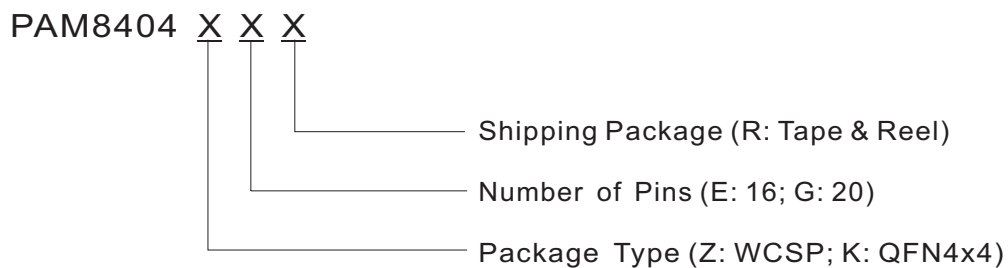

Part Number	Marking	Package Type	Shipping Package
PAM8404ZER	FR YW	WCSP 16	3,000 Units/Tape & Reel
PAM8404KGR	P8404 XXXYW	QFN4x4 20L	3,000 Units/Tape & Reel



### Outline Dimensions

**WCSP 2x2**

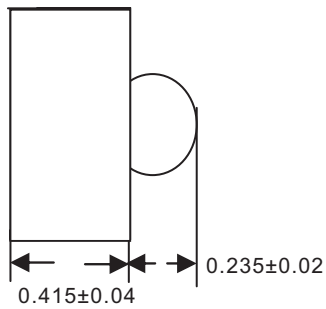
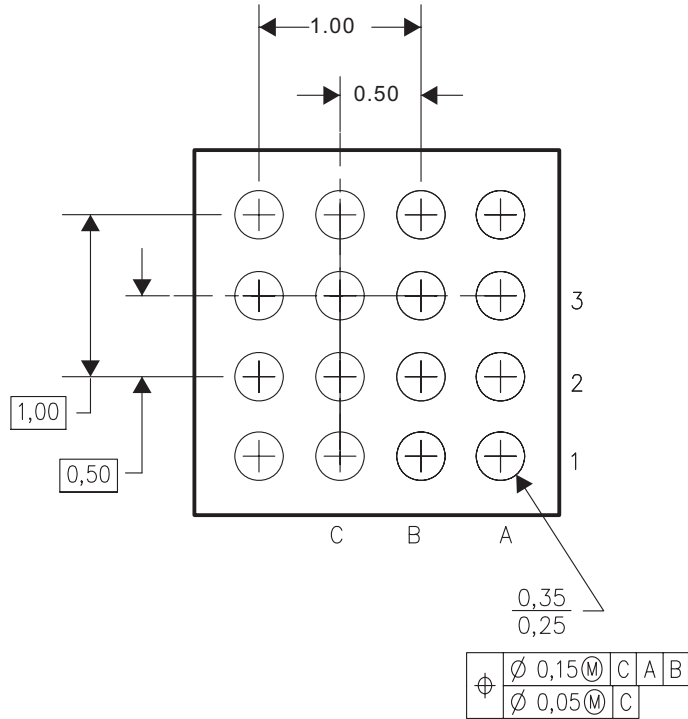
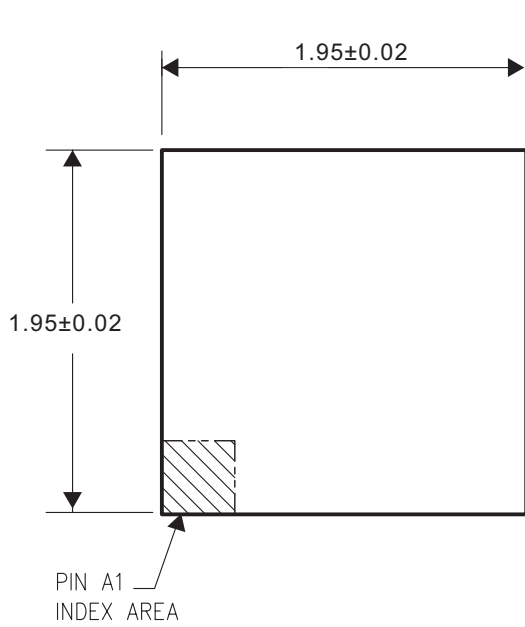

Units: Millimeter

### Outline Dimensions

QFN4x4-20L

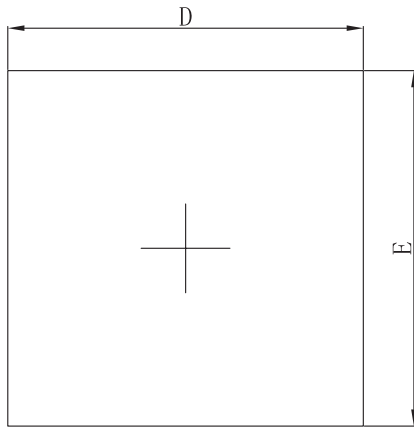

**Top View**

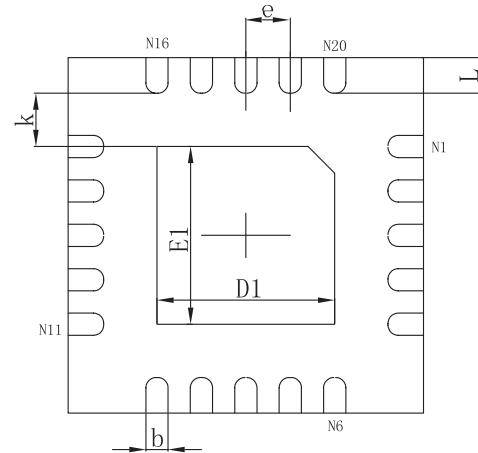

**Bottom View**

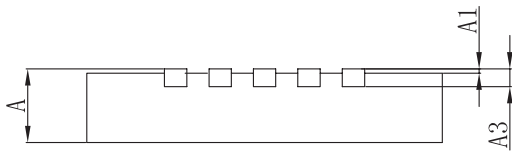

**Side View**

Symbol	Dimensions In Millimeters		Dimensions In Inches	
	Min.	Max.	Min.	Max.
A	0.700/0.800	0.800/0.900	0.028/0.031	0.031/0.035
A1	0.000	0.050	0.000	0.002
A3	0.203REF.		0.008REF.	
D	3.900	4.100	0.154	0.161
E	3.900	4.100	0.154	0.161
D1	1.900	2.100	0.075	0.083
E1	1.900	2.100	0.075	0.083
k	0.200MIN.		0.008MIN.	
b	0.180	0.300	0.007	0.012
e	0.500TYP.		0.020TYP.	
L	0.300	0.500	0.012	0.020

## Данный компонент на территории Российской Федерации

### Вы можете приобрести в компании MosChip.

Для оперативного оформления запроса Вам необходимо перейти по данной ссылке:

<http://moschip.ru/get-element>

Вы можете разместить у нас заказ для любого Вашего проекта, будь то серийное производство или разработка единичного прибора.

В нашем ассортименте представлены ведущие мировые производители активных и пассивных электронных компонентов.

Нашей специализацией является поставка электронной компонентной базы двойного назначения, продукции таких производителей как XILINX, Intel (ex.ALTERA), Vicor, Microchip, Texas Instruments, Analog Devices, Mini-Circuits, Amphenol, Glenair.

Сотрудничество с глобальными дистрибьюторами электронных компонентов, предоставляет возможность заказывать и получать с международных складов практически любой перечень компонентов в оптимальные для Вас сроки.

На всех этапах разработки и производства наши партнеры могут получить квалифицированную поддержку опытных инженеров.

Система менеджмента качества компании отвечает требованиям в соответствии с ГОСТ Р ИСО 9001, ГОСТ РВ 0015-002 и ЭС РД 009

### Офис по работе с юридическими лицами:

105318, г.Москва, ул.Щербаковская д.3, офис 1107, 1118, ДЦ «Щербаковский»

Телефон: +7 495 668-12-70 (многоканальный)

Факс: +7 495 668-12-70 (доб.304)

E-mail: [info@moschip.ru](mailto:info@moschip.ru)

Skype отдела продаж:

moschip.ru

moschip.ru\_4

moschip.ru\_6

moschip.ru\_9