



## DATA SHEET

# BIPOLAR ANALOG INTEGRATED CIRCUIT $\mu$ PC8179TK

### 3 V SILICON MMIC LOW CURRENT AMPLIFIER FOR MOBILE COMMUNICATIONS

#### DESCRIPTION

The  $\mu$ PC8179TK is a silicon monolithic integrated circuit designed as amplifier for mobile communications. This IC can realize low current consumption with external chip inductor which can not be realized on internal 50  $\Omega$  wide band matched IC.  $\mu$ PC8179TK adopts 6-pin lead-less minimold package using same chip as the conventional  $\mu$ PC8179TB in 6-pin super minimold.

TK suffix IC which is smaller package than TB suffix IC contributes to reduce mounting space by 50%.

This IC is manufactured using our 30 GHz  $f_{max}$  UHS0 (Ultra High Speed Process) silicon bipolar process.

#### FEATURES

- Low current consumption :  $I_{CC} = 4.0$  mA TYP. @  $V_{CC} = 3.0$  V
- Supply voltage :  $V_{CC} = 2.4$  to 3.3 V
- Excellent isolation : ISL = 43.0 dB TYP. @  $f = 1.0$  GHz  
ISL = 42.0 dB TYP. @  $f = 1.9$  GHz  
ISL = 42.0 dB TYP. @  $f = 2.4$  GHz
- Power gain :  $G_P = 13.5$  dB TYP. @  $f = 1.0$  GHz  
 $G_P = 15.5$  dB TYP. @  $f = 1.9$  GHz  
 $G_P = 16.0$  dB TYP. @  $f = 2.4$  GHz
- Gain 1 dB compression output power :  $P_{O(1\text{ dB})} = +2.0$  dBm TYP. @  $f = 1.0$  GHz  
 $P_{O(1\text{ dB})} = +0.5$  dBm TYP. @  $f = 1.9$  GHz  
 $P_{O(1\text{ dB})} = +0.5$  dBm TYP. @  $f = 2.4$  GHz
- Operating frequency : 0.1 to 2.4 GHz (Output port LC matching)
- High-density surface mounting : 6-pin lead-less minimold package (1.5  $\times$  1.3  $\times$  0.55 mm)
- Light weight : 3 mg (Standard value)

#### APPLICATION

- Buffer amplifiers on 0.1 to 2.4 GHz mobile communications system

**Caution: Observe precautions when handling because these devices are sensitive to electrostatic discharge**

The information in this document is subject to change without notice. Before using this document, please confirm that this is the latest version.

**ORDERING INFORMATION**

Part Number	Order Number	Package	Marking	Supplying Form
μPC8179TK-E2	μPC8179TK-E2-A	6-pin lead-less minimold (1511) (Pb-Free) <sup>Note</sup>	6C	<ul style="list-style-type: none"> <li>• Embossed tape 8 mm wide</li> <li>• Pin 1, 6 face the perforation side of the tape</li> <li>• Qty 5 kpcs/reel</li> </ul>

**Note** With regards to terminal solder (the solder contains lead) plated products (conventionally plated), contact your nearby sales office.

**Remark** To order evaluation samples, contact your nearby sales office.  
Part number for sample order: μPC8179TK-A

**PRODUCT LINE-UP (T<sub>A</sub> = +25°C, V<sub>CC</sub> = V<sub>out</sub> = 3.0 V, Z<sub>S</sub> = Z<sub>L</sub> = 50 Ω)**

Parameter Part No.	I <sub>CC</sub> (mA)	1.0 GHz output port matching frequency			1.66 GHz output port matching frequency			1.9 GHz output port matching frequency			2.4 GHz output port matching frequency			Marking
		G <sub>P</sub> (dB)	ISL (dB)	P <sub>O (1dB)</sub> (dBm)	G <sub>P</sub> (dB)	ISL (dB)	P <sub>O (1dB)</sub> (dBm)	G <sub>P</sub> (dB)	ISL (dB)	P <sub>O (1dB)</sub> (dBm)	G <sub>P</sub> (dB)	ISL (dB)	P <sub>O (1dB)</sub> (dBm)	
μPC8178TB	1.9	11.0	39.0	-4.0	-	-	-	11.5	40.0	-7.0	11.5	38.0	-7.5	C3B
μPC8178TK	1.9	11.0	40.0	-5.5	-	-	-	11.0	41.0	-8.0	11.0	42.0	-8.0	6B
μPC8179TB	4.0	13.5	44.0	+3.0	-	-	-	15.5	42.0	+1.5	15.5	41.0	+1.0	C3C
μPC8179TK	4.0	13.5	43.0	+2.0	-	-	-	15.5	42.0	+0.5	16.0	42.0	+0.5	6C
μPC8128TB	2.8	12.5	39.0	-4.0	13.0	39.0	-4.0	13.0	37.0	-4.0	-	-	-	C2P
μPC8151TB	4.2	12.5	38.0	+2.5	15.0	36.0	+1.5	15.0	34.0	+0.5	-	-	-	C2U
μPC8152TB	5.6	23.0	40.0	-4.5	19.5	38.0	-8.5	17.5	35.0	-8.5	-	-	-	C2V

**Remarks** 1. Typical performance. Please refer to **ELECTRICAL CHARACTERISTICS** in detail.  
2. To know the associated product, please refer to each latest data sheet.

**SYSTEM APPLICATION EXAMPLE**

Location examples in digital cellular

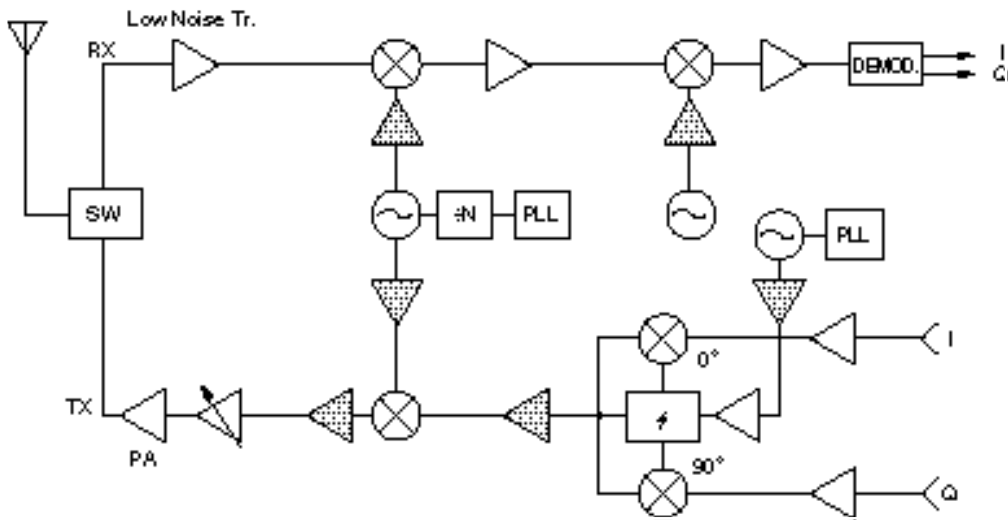

These ICs can be added to your system around  $\Delta$  parts, when you need more isolation or gain. The application herein, however, shows only examples, therefore the application can depend on your kit evaluation.

**PIN CONNECTIONS**

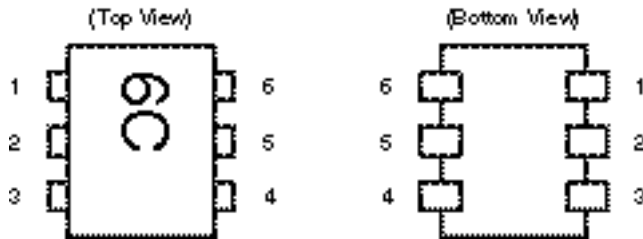

Pin No.	Pin Name
1	INPUT
2	GND
3	GND
4	OUTPUT
5	GND
6	V <sub>cc</sub>

**PIN EXPLANATION**

Pin No.	Pin Name	Applied Voltage (V)	Pin Voltage (V) <small>Note</small>	Function and Applications	Internal Equivalent Circuit
1	INPUT	–	0.90	Signal input pin. A internal matching circuit, configured with resistors, enables 50 Ω connection over a wide band. This pin must be coupled to signal source with capacitor for DC cut.	
2 3 5	GND	0	–	Ground pin. This pin should be connected to system ground with minimum inductance. Ground pattern on the board should be formed as wide as possible. All the ground pins must be connected together with wide ground pattern to decrease impedance defference.	
4	OUTPUT	Voltage as same as V <sub>cc</sub> through external inductor	–	Signal output pin. This pin is designed as collector output. Due to the high impedance output, this pin should be externally equipped with LC matching circuit to next stage. For L, a size 1 005 chip inductor can be chosen.	
6	V <sub>cc</sub>	2.4 to 3.3	–	Power supply pin. This pin should be externally equipped with bypass capacitor to minimize its impedance.	

**Note** Pin voltage is measured at V<sub>cc</sub> = 3.0 V.

**ABSOLUTE MAXIMUM RATINGS**

Parameter	Symbol	Test Conditions	Ratings	Unit
Supply Voltage	V <sub>CC</sub>	T <sub>A</sub> = +25°C, Pin 4, Pin 6	3.6	V
Circuit Current	I <sub>CC</sub>	T <sub>A</sub> = +25°C	15	mA
Power Dissipation	P <sub>D</sub>	T <sub>A</sub> = +85°C <b>Note</b>	232	mW
Operating Ambient Temperature	T <sub>A</sub>		-40 to +85	°C
Storage Temperature	T <sub>stg</sub>		-55 to +150	°C
Input Power	P <sub>in</sub>	T <sub>A</sub> = +25°C	+5	dBm

**Note** Mounted on double-sided copper-clad 50 × 50 × 1.6 mm epoxy glass PWB

**RECOMMENDED OPERATING RANGE**

Parameter	Symbol	MIN.	TYP.	MAX.	Unit	Remarks
Supply Voltage	V <sub>CC</sub>	2.4	3.0	3.3	V	The same voltage should be applied to pin 4 and pin 6.
Operating Ambient Temperature	T <sub>A</sub>	-40	+25	+85	°C	

**ELECTRICAL CHARACTERISTICS**

(Unless otherwise specified, T<sub>A</sub> = +25°C, V<sub>CC</sub> = V<sub>out</sub> = 3.0 V, Z<sub>s</sub> = Z<sub>L</sub> = 50 Ω, at LC matched frequency)

Parameter	Symbol	Test Conditions	MIN.	TYP.	MAX.	Unit
Circuit Current	I <sub>CC</sub>	No signal	2.9	4.0	5.4	mA
Power Gain	G <sub>P</sub>	f = 1.0 GHz, P <sub>in</sub> = -30 dBm f = 1.9 GHz, P <sub>in</sub> = -30 dBm f = 2.4 GHz, P <sub>in</sub> = -30 dBm	11.0 13.0 14.0	13.5 15.5 16.0	15.5 17.5 18.5	dB
Isolation	ISL	f = 1.0 GHz, P <sub>in</sub> = -30 dBm f = 1.9 GHz, P <sub>in</sub> = -30 dBm f = 2.4 GHz, P <sub>in</sub> = -30 dBm	39.0 37.0 37.0	43.0 42.0 42.0	- - -	dB
Gain 1 dB Compression Output Power	P <sub>O(1 dB)</sub>	f = 1.0 GHz f = 1.9 GHz f = 2.4 GHz	-0.5 -2.0 -3.0	+2.0 +0.5 +0.5	- - -	dBm
Noise Figure	NF	f = 1.0 GHz f = 1.9 GHz f = 2.4 GHz	- - -	5.0 5.0 5.0	6.5 6.5 6.5	dB
Input Return Loss	RL <sub>in</sub>	f = 1.0 GHz, P <sub>in</sub> = -30 dBm f = 1.9 GHz, P <sub>in</sub> = -30 dBm f = 2.4 GHz, P <sub>in</sub> = -30 dBm	4.0 4.0 6.0	7.0 7.0 9.0	- - -	dB

TEST CIRCUITS

<1>  $f = 1.0 \text{ GHz}$

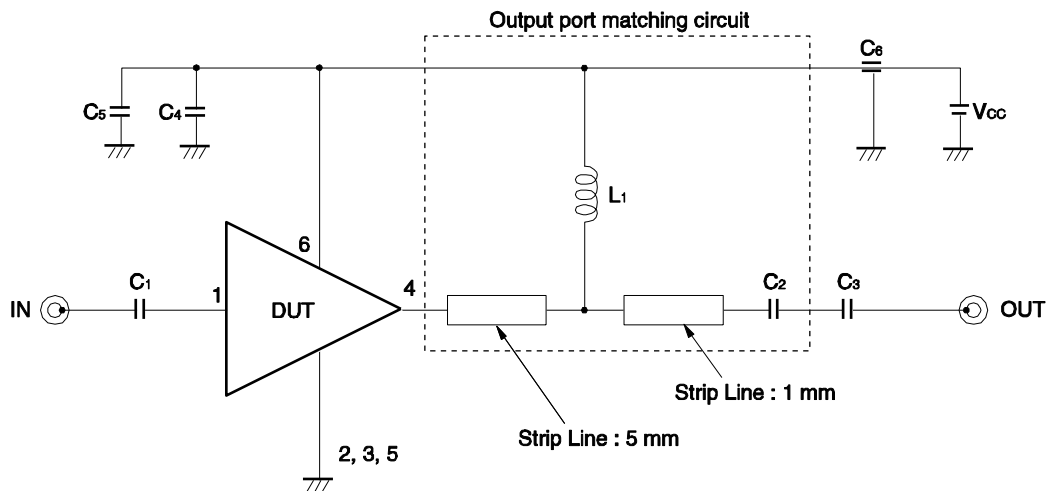

<2>  $f = 1.9 \text{ GHz}$

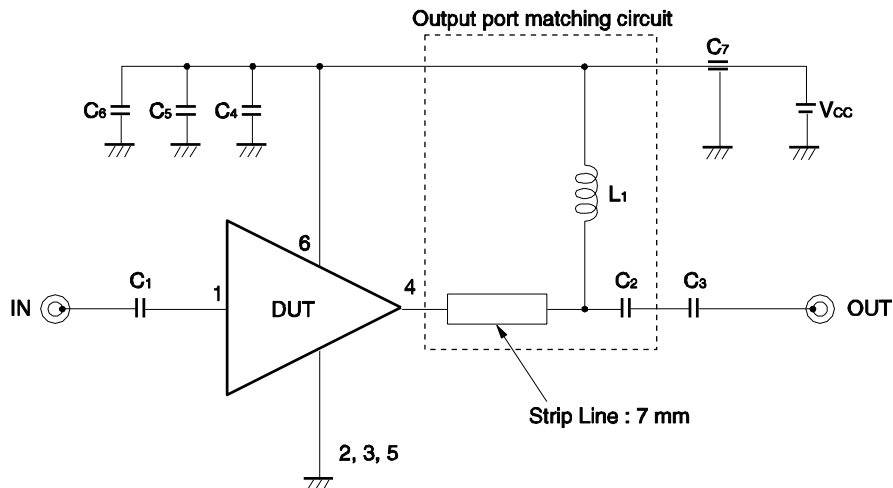

<3>  $f = 2.4 \text{ GHz}$

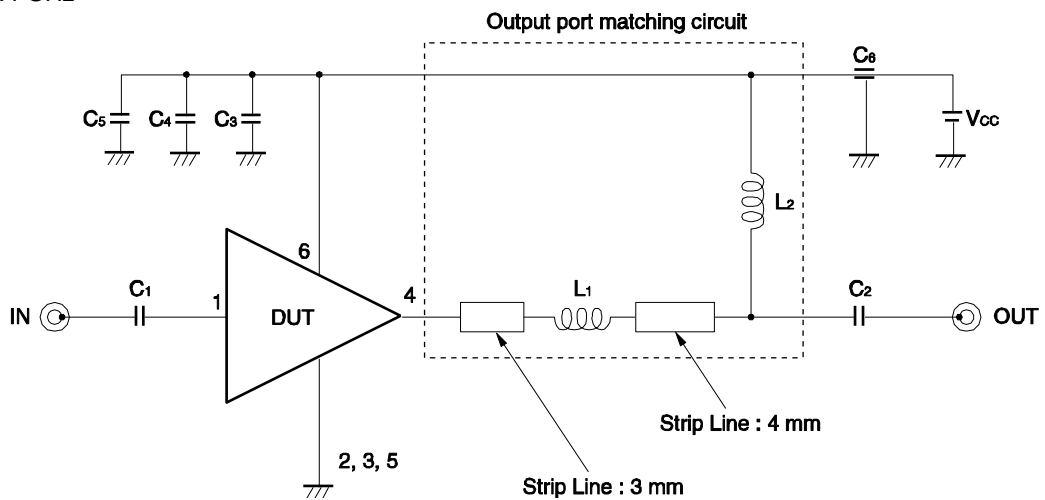
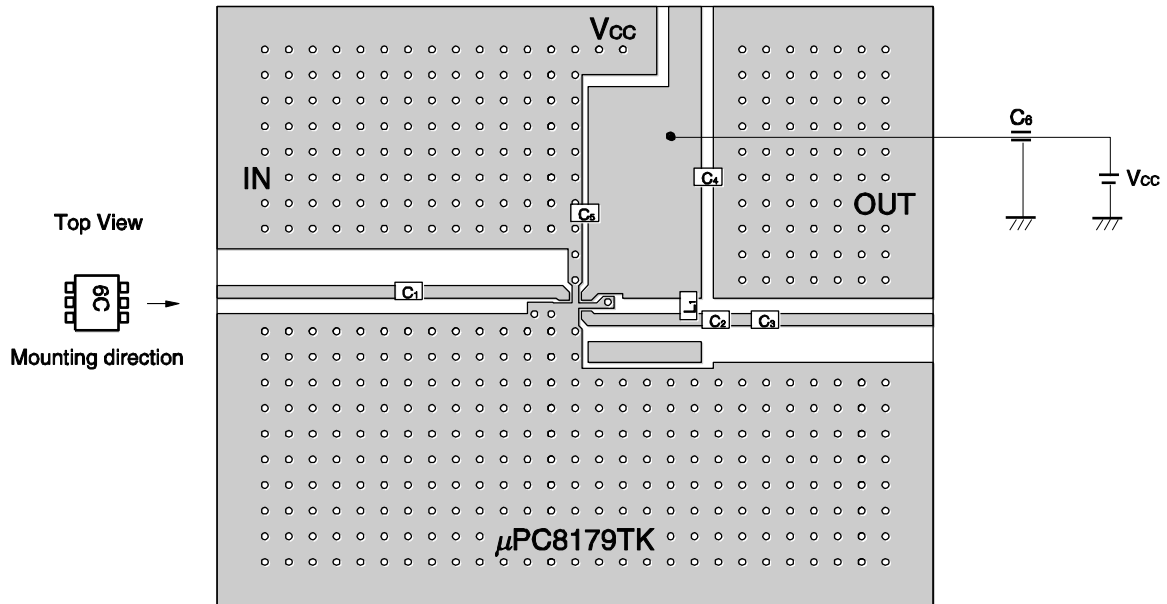

ILLUSTRATION OF THE TEST CIRCUIT ASSEMBLED ON EVALUATION BOARD

<1> f = 1.0 GHz



- Remarks 1.** 42 × 35 × 0.4 mm double-sided copper-clad polyimide board  
**2.** Back side: GND pattern  
**3.** Gold plated on pattern  
**4.** o :Through holes

**COMPONENT LIST**

Form	Symbol	Value	Type code	Maker
Chip capacitor	C <sub>1</sub> , C <sub>3</sub>	1 000 pF	GRM40CH102J50PT	murata
	C <sub>2</sub>	0.75 pF	GRM39CKR75C50PT	murata
	C <sub>4</sub>	5 pF	GRM39CH050C50PT	murata
	C <sub>5</sub>	8 pF	GRM39CH080D50PT	murata
Feed-through Capacitor	C <sub>6</sub>	1 000 pF	DFT301-801 × 7R102S50	murata
Chip inductor	L <sub>1</sub>	12 nH	LL1608-FH12N	TOKO

<2> f = 1.9 GHz

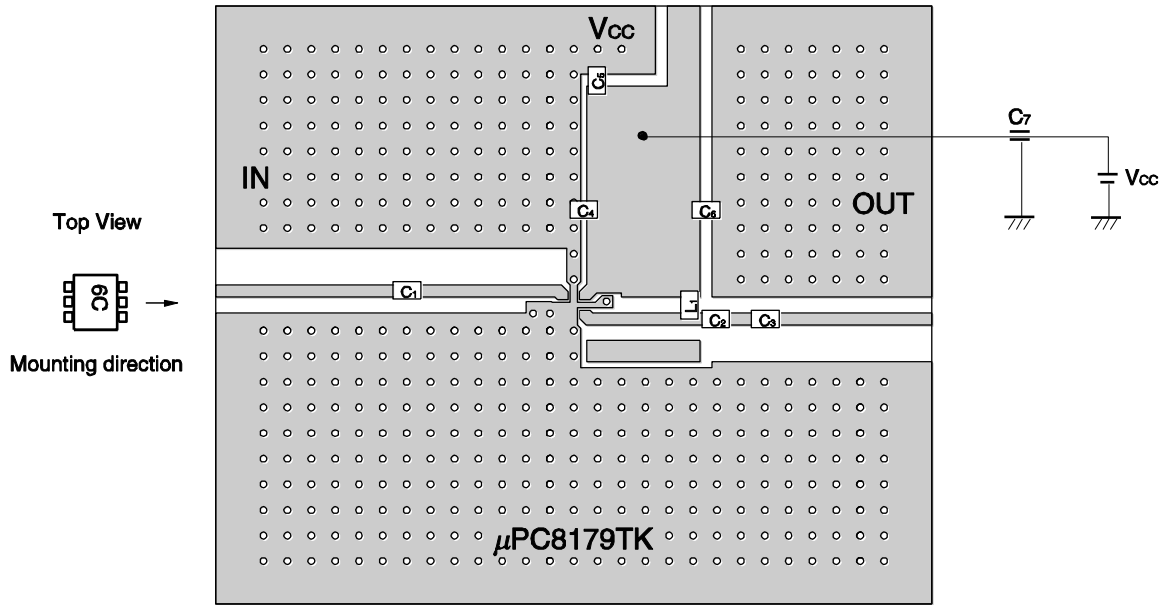

- Remarks 1.** 42 × 35 × 0.4 mm double-sided copper-clad polyimide board  
**2.** Back side: GND pattern  
**3.** Gold plated on pattern  
**4.** o :Through holes

**COMPONENT LIST**

Form	Symbol	Value	Type code	Maker
Chip capacitor	C <sub>1</sub> , C <sub>3</sub> , C <sub>5</sub> , C <sub>6</sub>	1 000 pF	GRM40CH102J50PT	murata
	C <sub>2</sub>	0.5 pF	GRM39CKR5C50PT	murata
	C <sub>4</sub>	8 pF	GRM39CH080D50PT	murata
Feed-through Capacitor	C <sub>7</sub>	1 000 pF	DFT301-801 × 7R102S50	murata
Chip inductor	L <sub>1</sub>	2.7 nH	LL1608-FH2N7S	TOKO



<3> f = 2.4 GHz

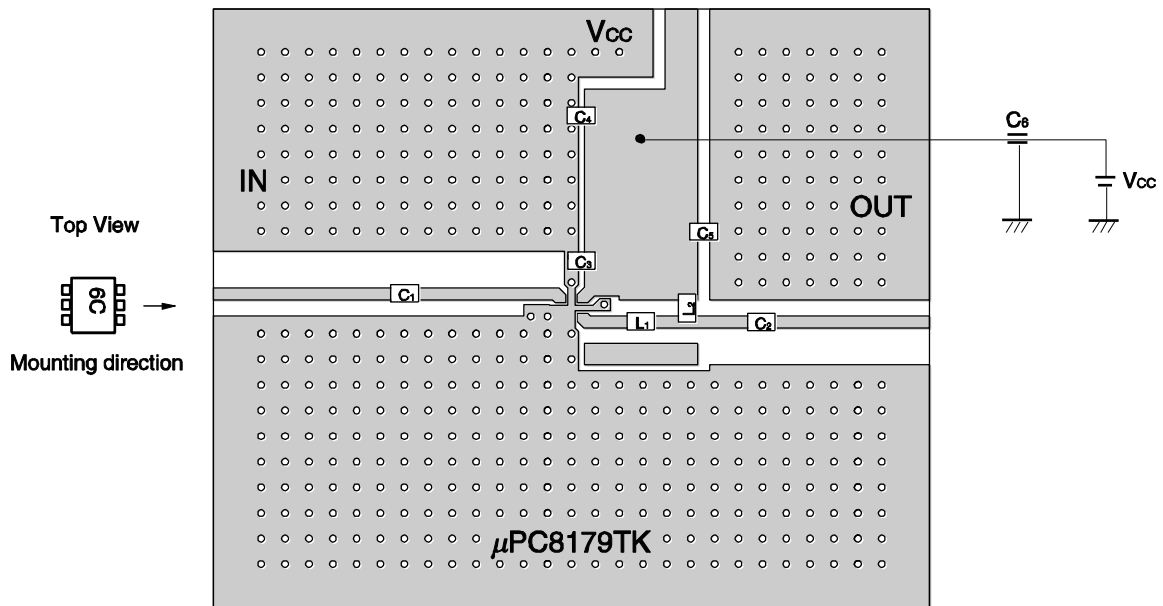

- Remarks 1.** 42 × 35 × 0.4 mm double-sided copper-clad polyimide board  
**2.** Back side: GND pattern  
**3.** Gold plated on pattern  
**4.** ○ :Through holes

**COMPONENT LIST**

Form	Symbol	Value	Type code	Maker
Chip capacitor	C <sub>1</sub> , C <sub>2</sub> , C <sub>4</sub> , C <sub>5</sub>	1 000 pF	GRM40CH102J50PT	murata
	C <sub>3</sub>	10 pF	GRM39CH100D50PT	murata
Feed-through Capacitor	C <sub>6</sub>	1 000 pF	DFT301-801 × 7R102S50	murata
Chip inductor	L <sub>1</sub>	2.7 nH	LL1608-FH2N7S	TOKO
	L <sub>2</sub>	1.8 nH	LL1608-FH1N8S	TOKO

■ TYPICAL CHARACTERISTICS ( $T_A = +25^\circ\text{C}$ , unless otherwise specified)

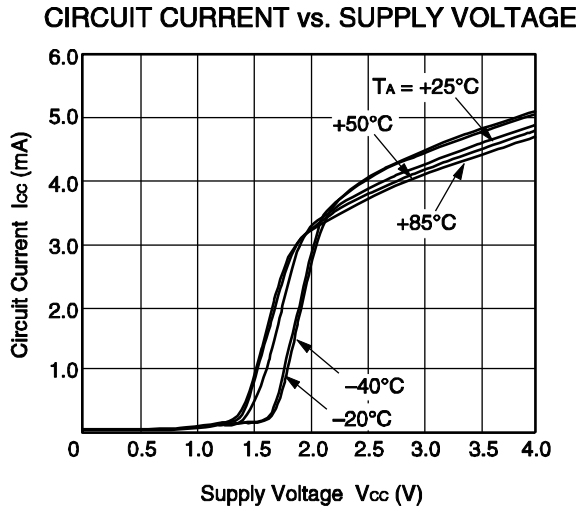

**Remark** The graph indicates nominal characteristics.

f = 1.0 GHz MATCHING

S11-FREQUENCY

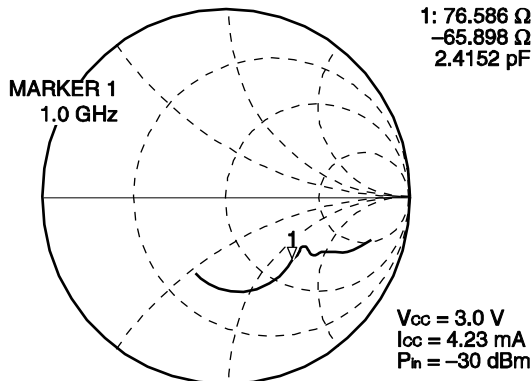

START 100.000 000 MHz STOP 3 100.000 000 MHz

S22-FREQUENCY

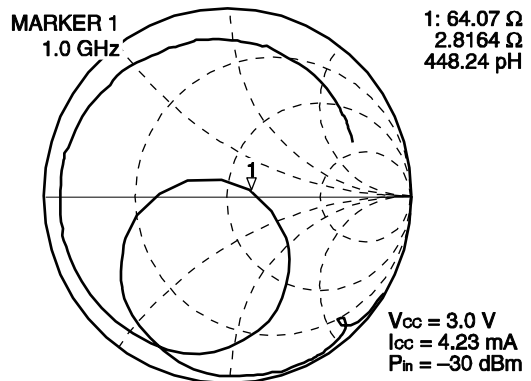

START 100.000 000 MHz STOP 3 100.000 000 MHz

S11-FREQUENCY

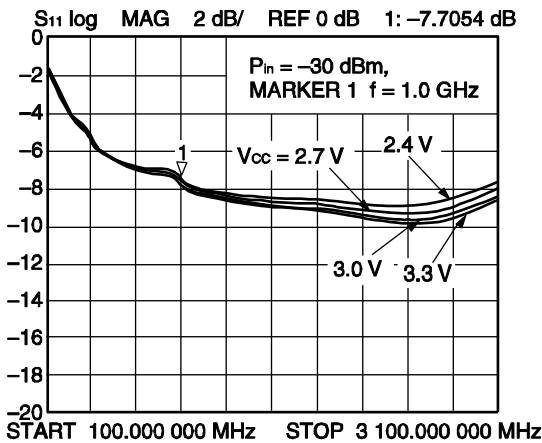

S12-FREQUENCY

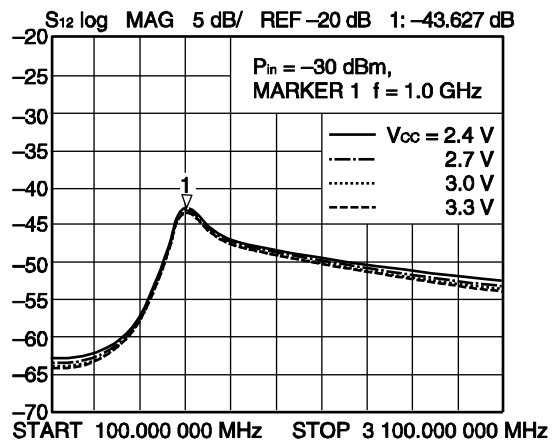

S21-FREQUENCY

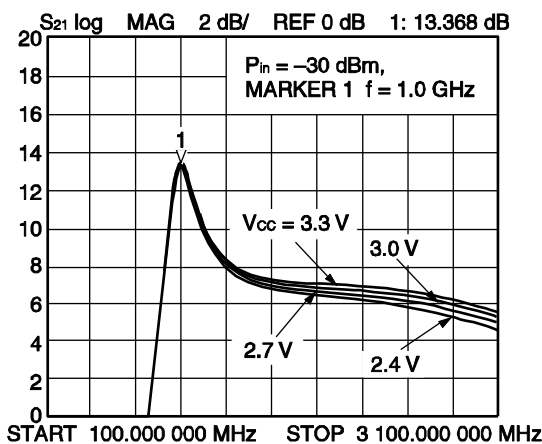

S22-FREQUENCY

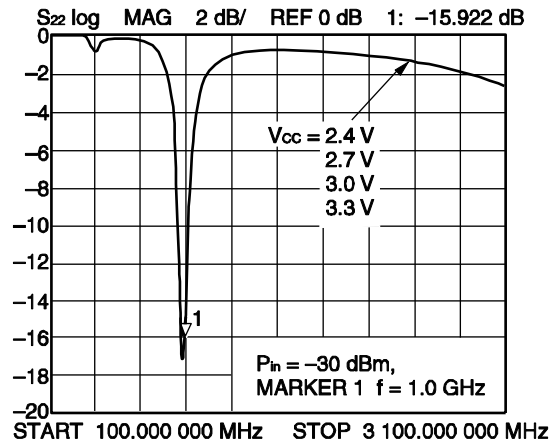

Remark The graphs indicate nominal characteristics.

S<sub>11</sub>-FREQUENCY

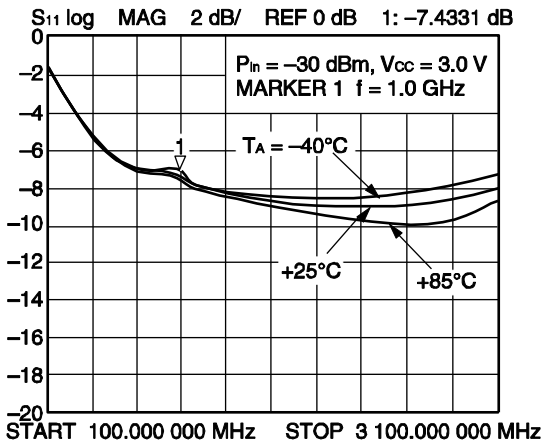

S<sub>12</sub>-FREQUENCY

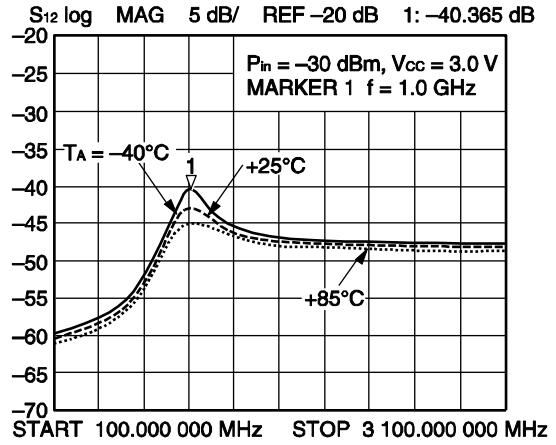

S<sub>21</sub>-FREQUENCY

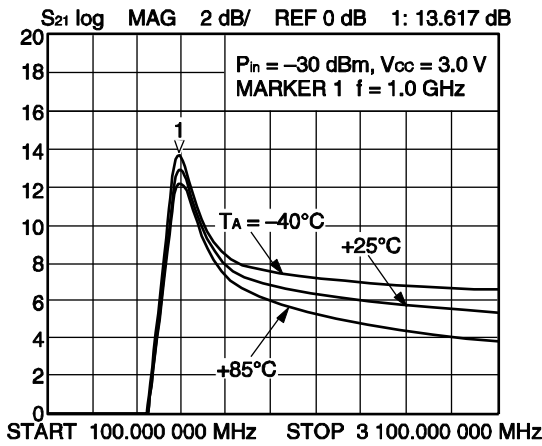

S<sub>22</sub>-FREQUENCY

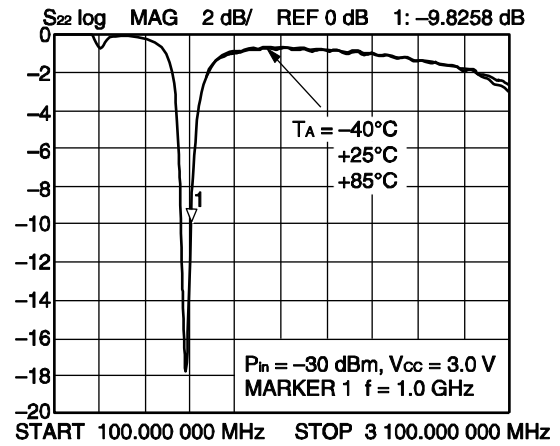

Remark The graphs indicate nominal characteristics.

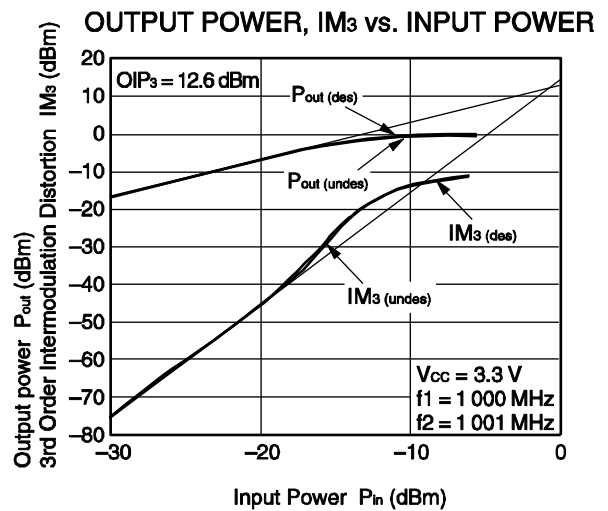
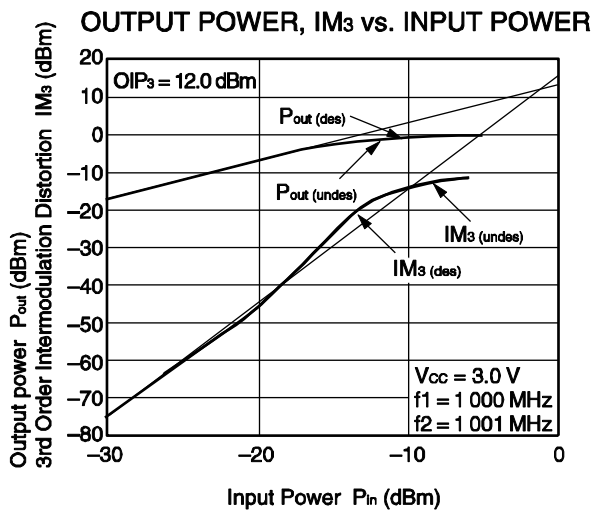
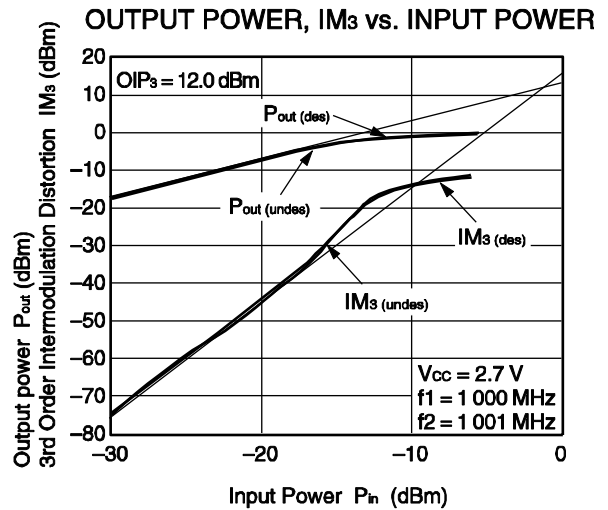
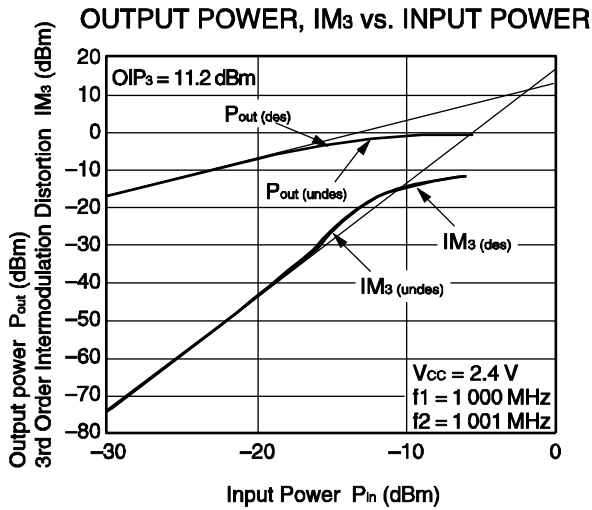
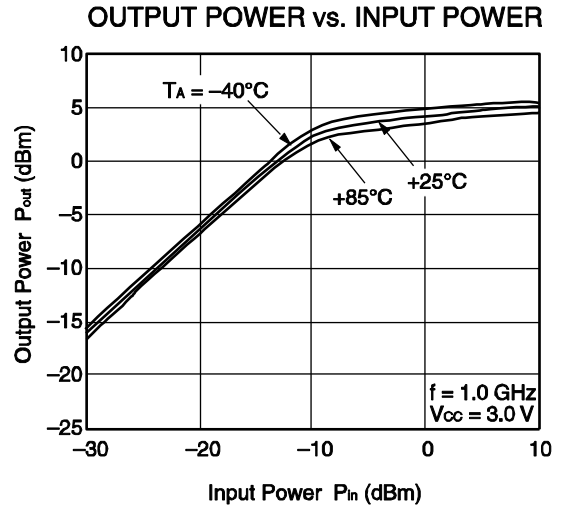
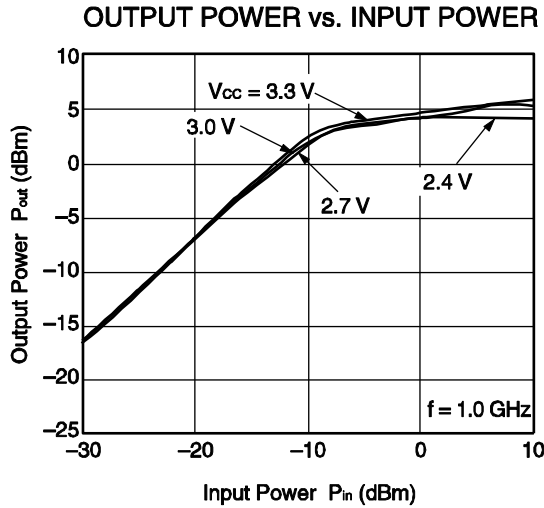

**Remark** The graphs indicate nominal characteristics.

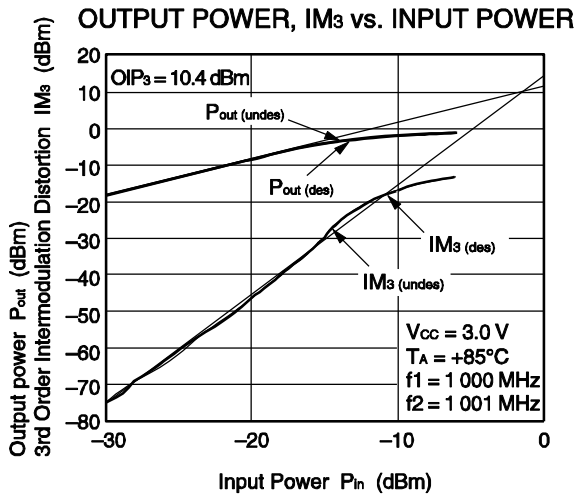
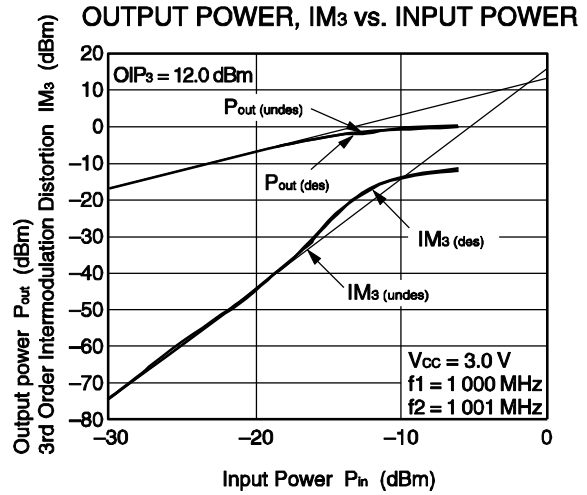
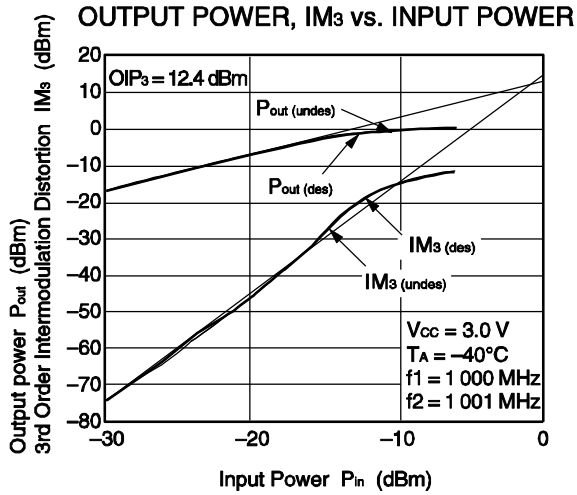

**3RD ORDER INTERMODULATION DISTORTION vs. OUTPUT POWER OF EACH TONE**

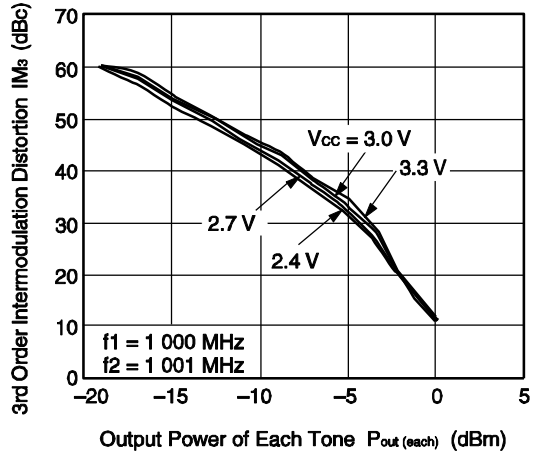

**NOISE FIGURE vs. SUPPLY VOLTAGE**

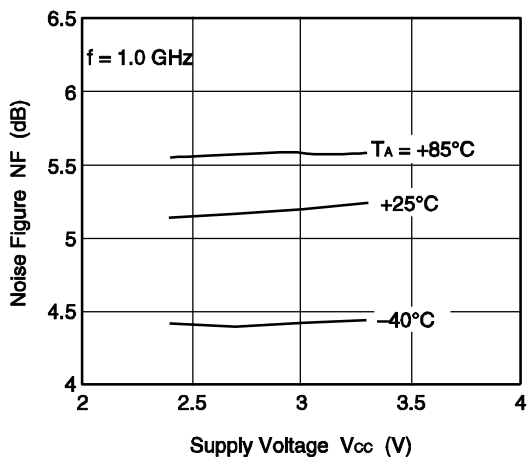

**Remark** The graphs indicate nominal characteristics.

f = 1.9 GHz MATCHING

S11-FREQUENCY

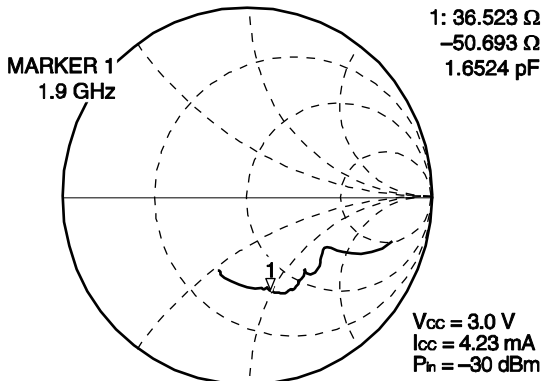

START 100.000 000 MHz STOP 3 100.000 000 MHz

S22-FREQUENCY

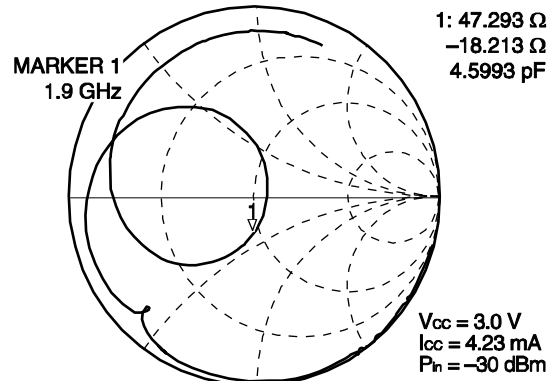

START 100.000 000 MHz STOP 3 100.000 000 MHz

S11-FREQUENCY

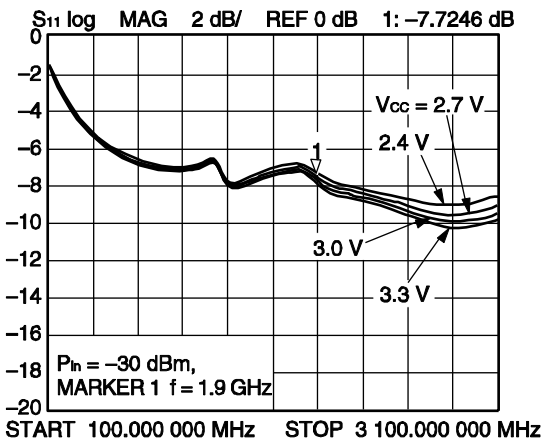

S12-FREQUENCY

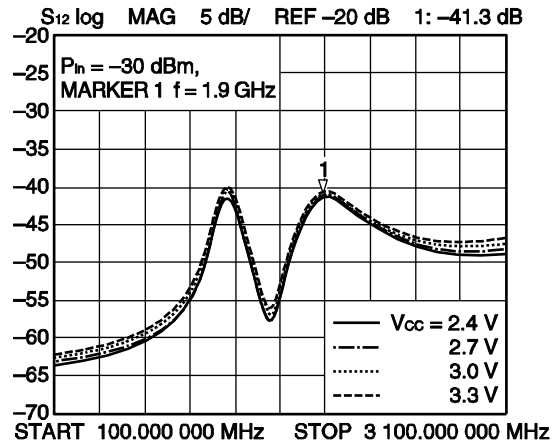

S21-FREQUENCY

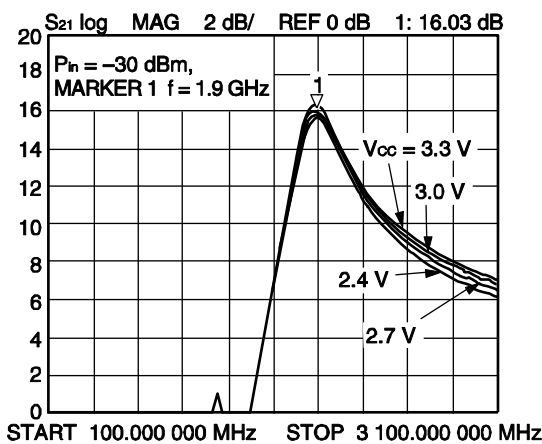

S22-FREQUENCY

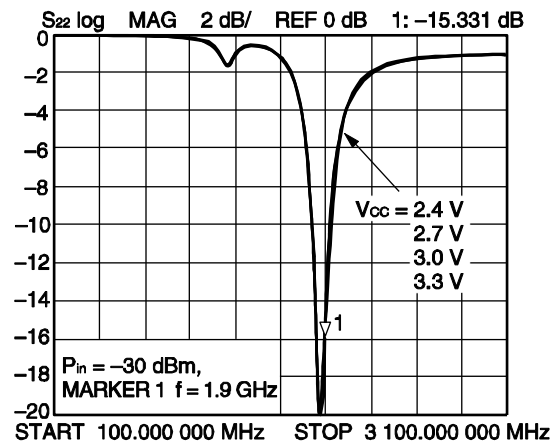

Remark The graphs indicate nominal characteristics.

S<sub>11</sub>-FREQUENCY

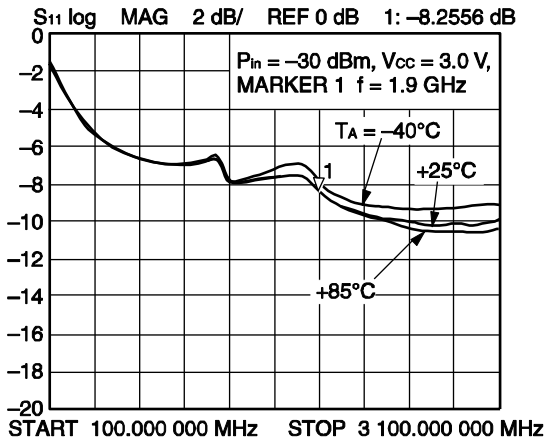

S<sub>12</sub>-FREQUENCY

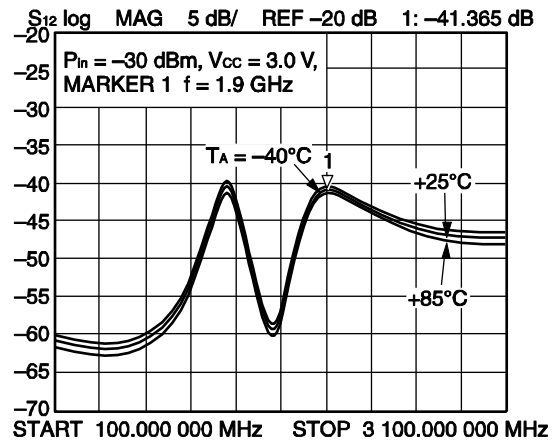

S<sub>21</sub>-FREQUENCY

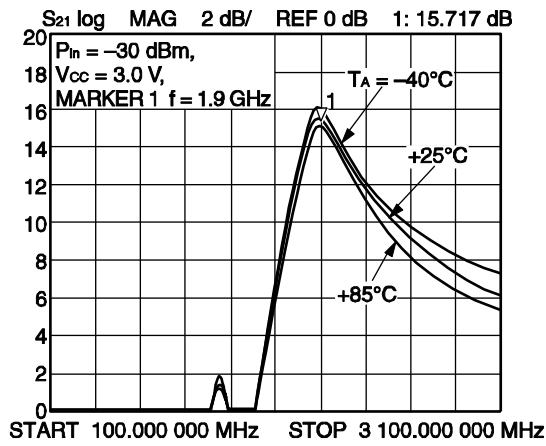

S<sub>22</sub>-FREQUENCY

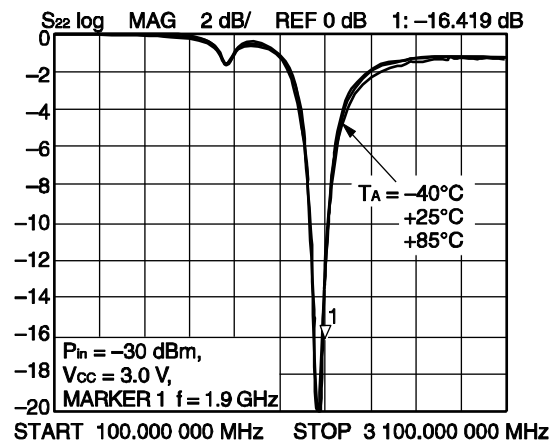

**Remark** The graphs indicate nominal characteristics.



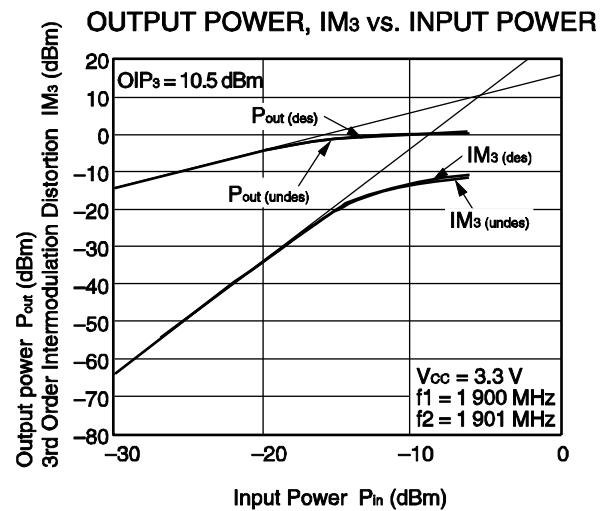
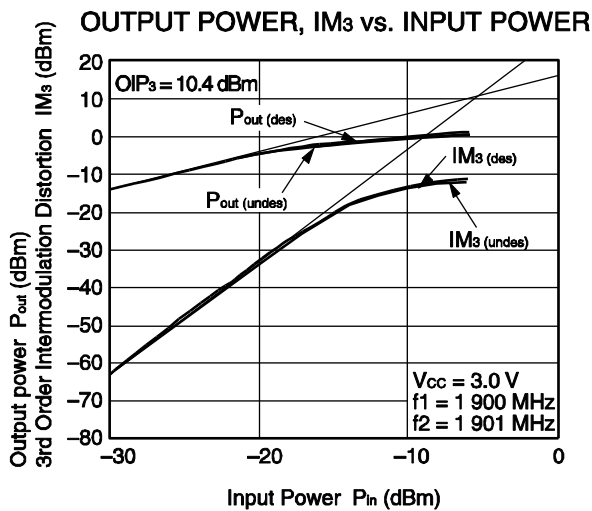
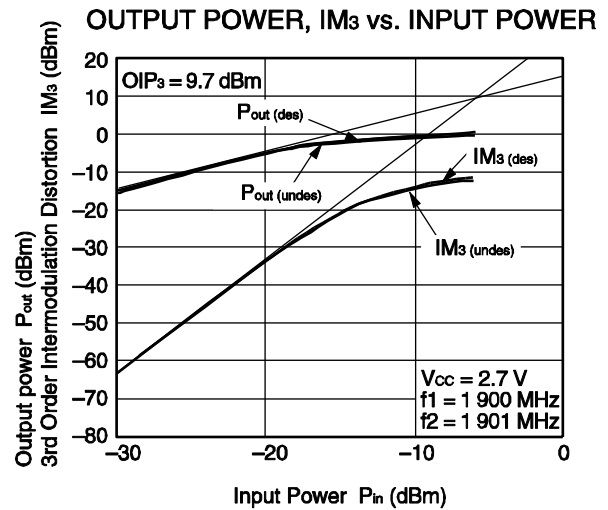
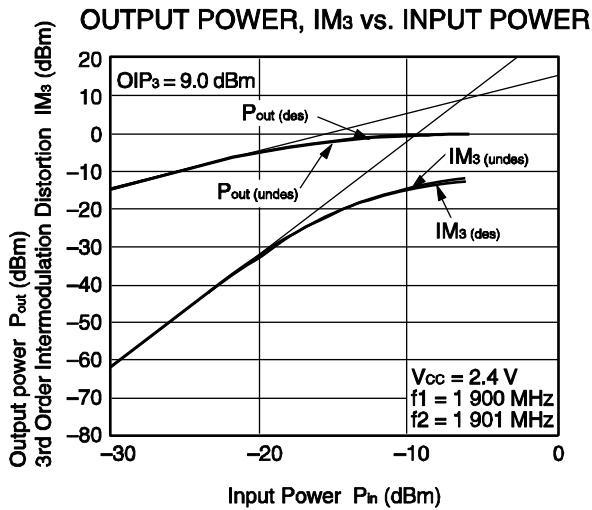
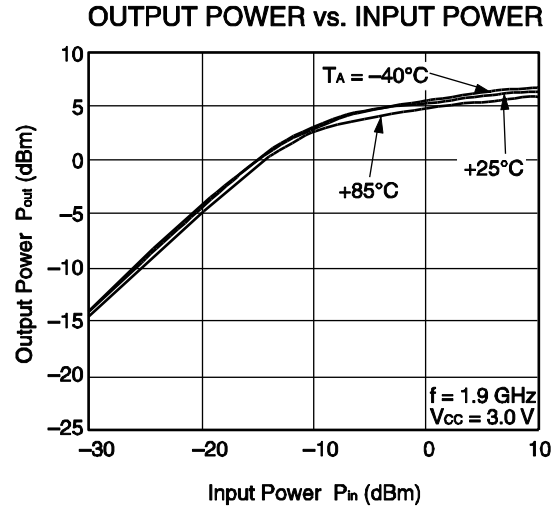
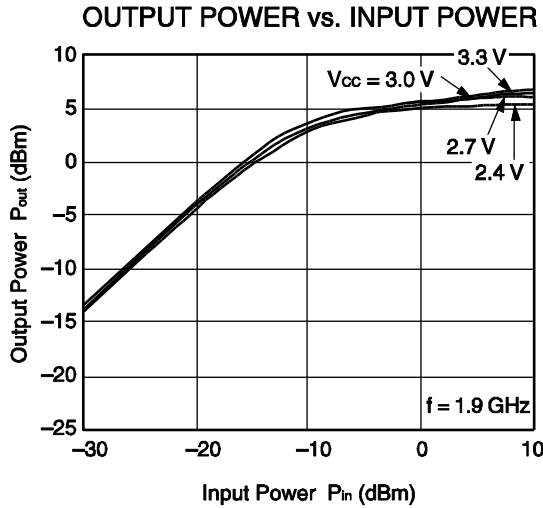

**Remark** The graphs indicate nominal characteristics.

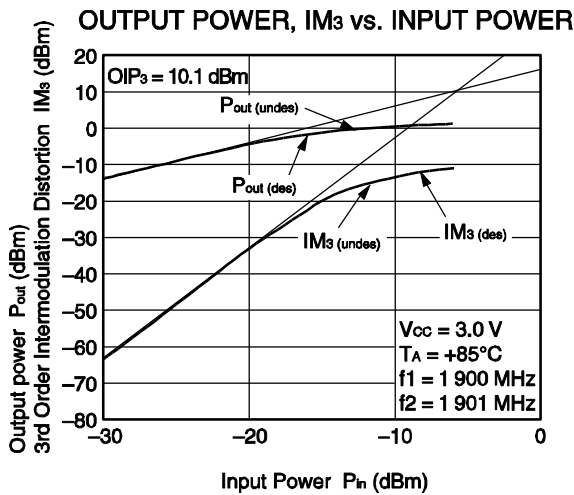
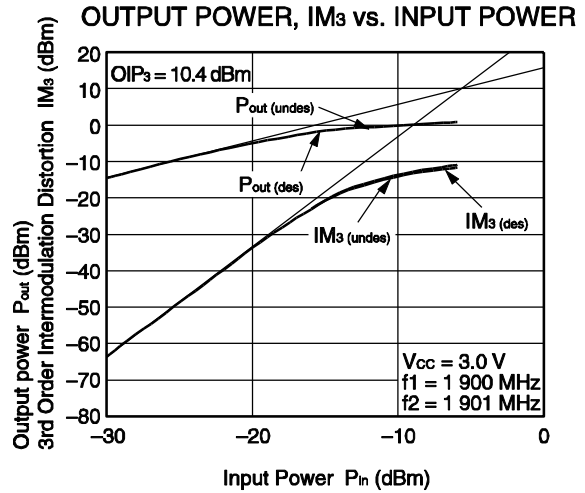
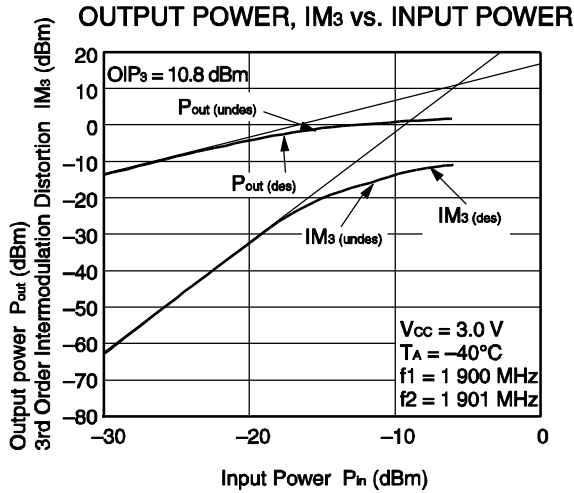

### 3RD ORDER INTERMODULATION DISTORTION vs. OUTPUT POWER OF EACH TONE

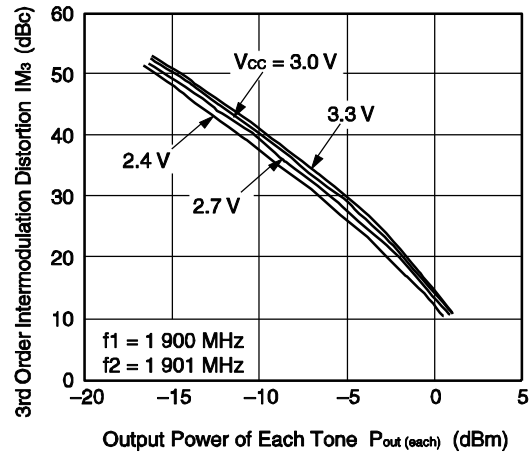

### NOISE FIGURE vs. SUPPLY VOLTAGE

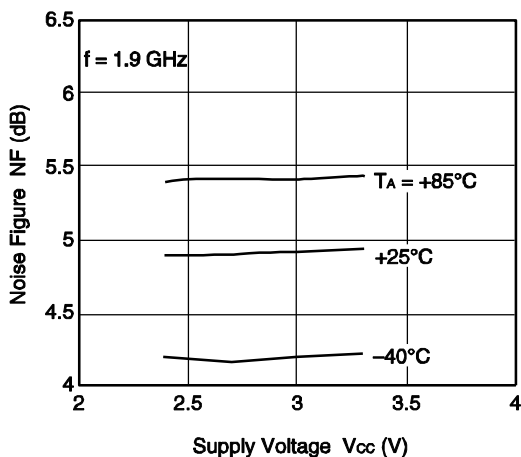

**Remark** The graphs indicate nominal characteristics.

f = 2.4 GHz MATCHING

S11-FREQUENCY

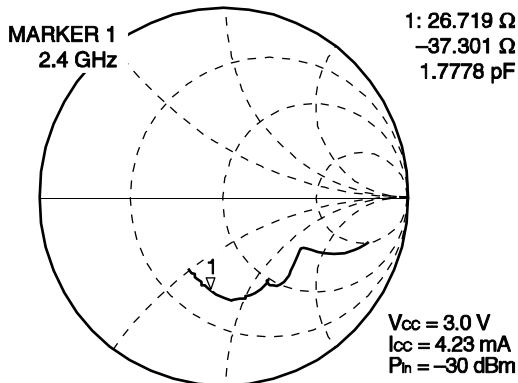

START 100.000 000 MHz STOP 3 100.000 000 MHz

S22-FREQUENCY

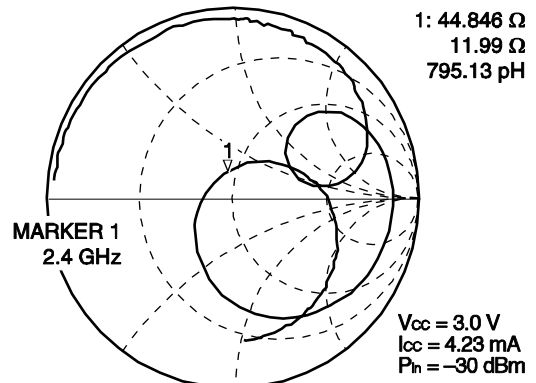

START 100.000 000 MHz STOP 3 100.000 000 MHz

S11-FREQUENCY

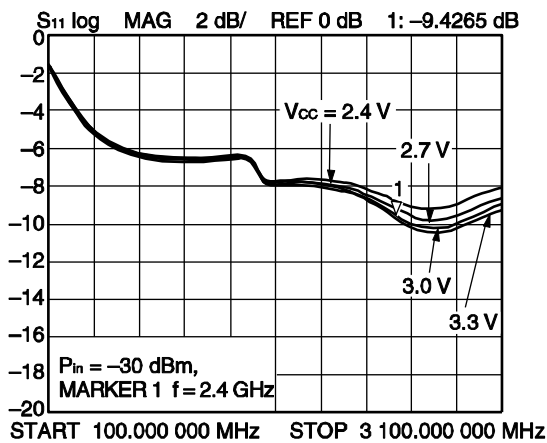

S12-FREQUENCY

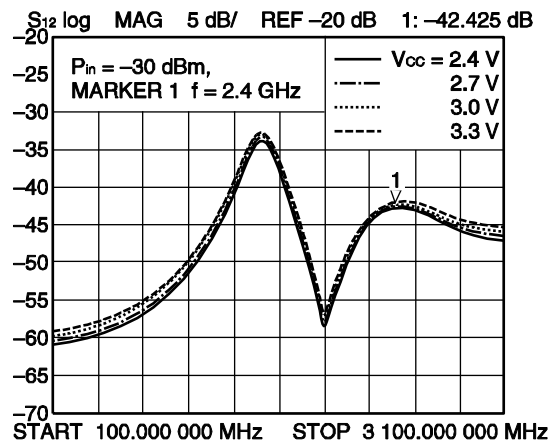

S21-FREQUENCY

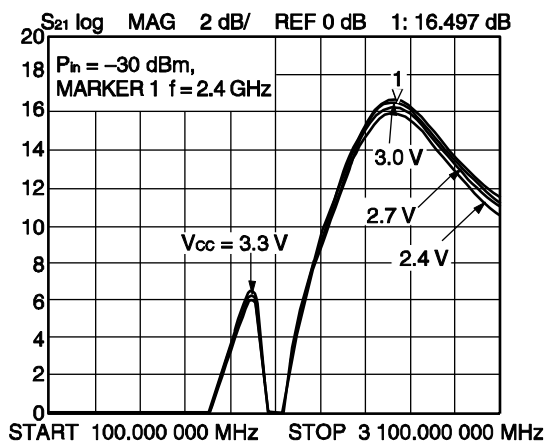

S22-FREQUENCY

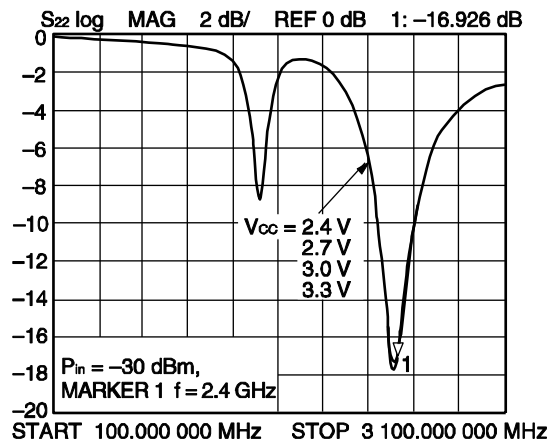

Remark The graphs indicate nominal characteristics.

S11-FREQUENCY

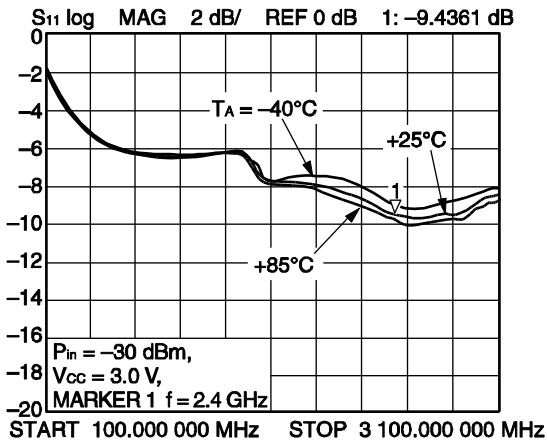

S12-FREQUENCY

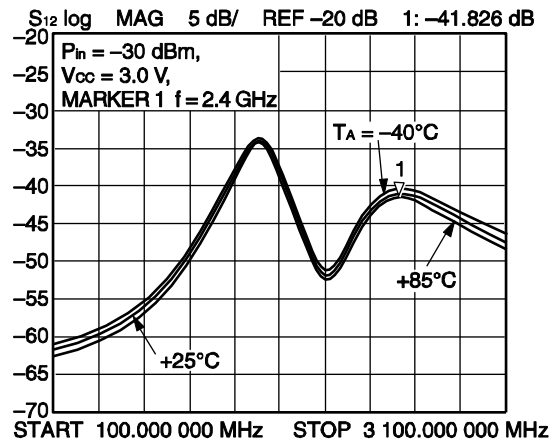

S21-FREQUENCY

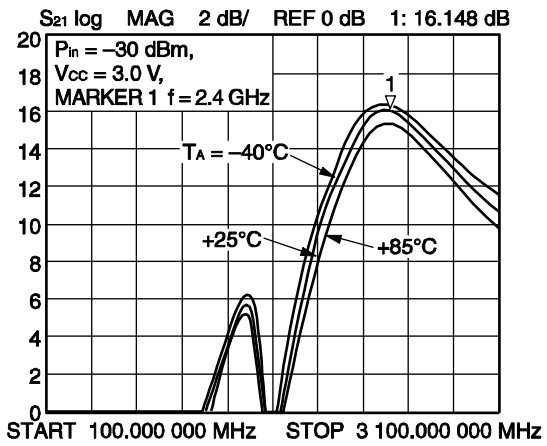

S22-FREQUENCY

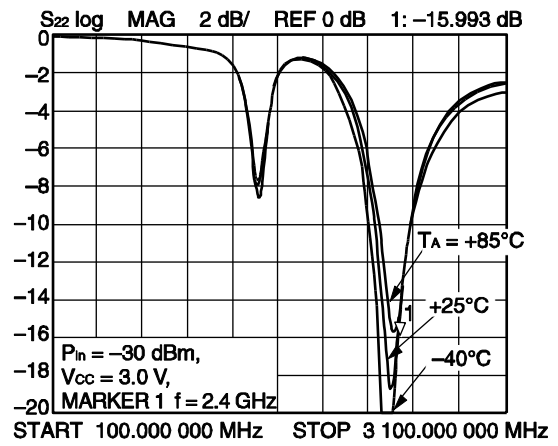

Remark The graphs indicate nominal characteristics.

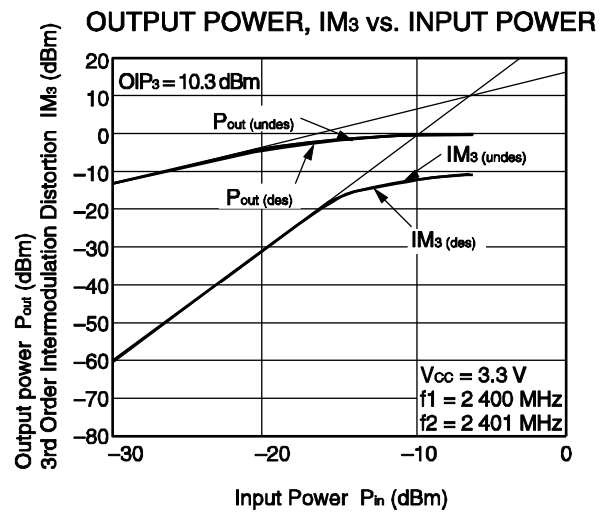
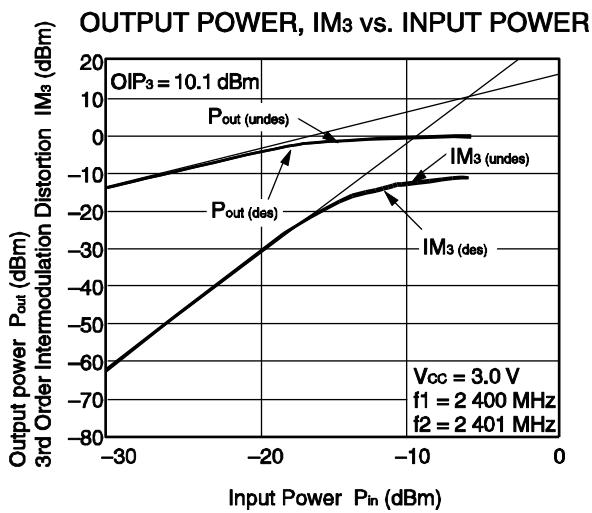
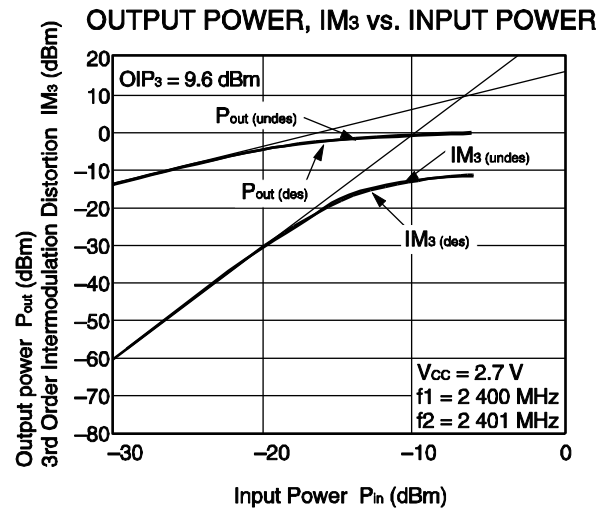
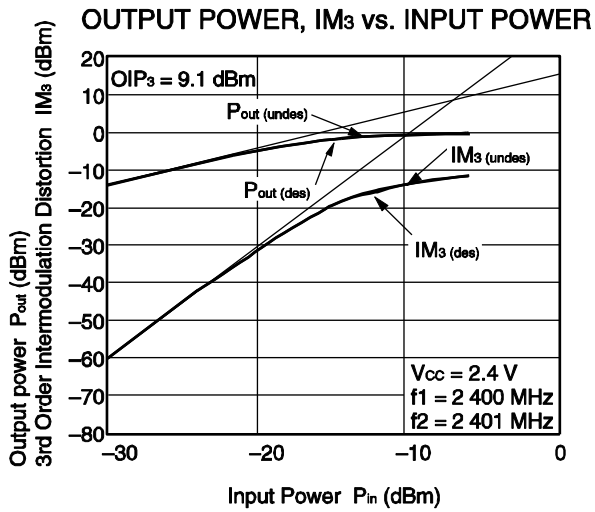
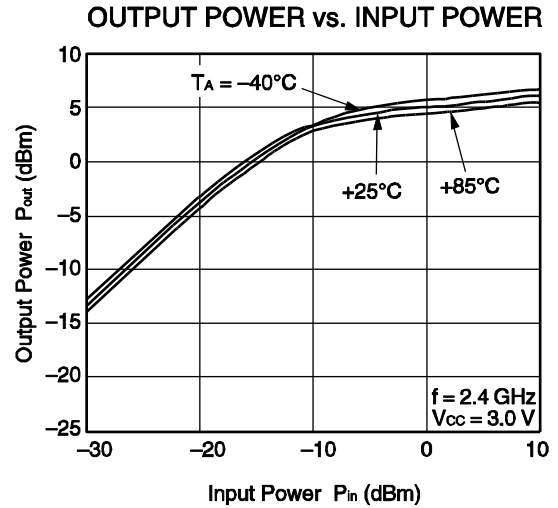
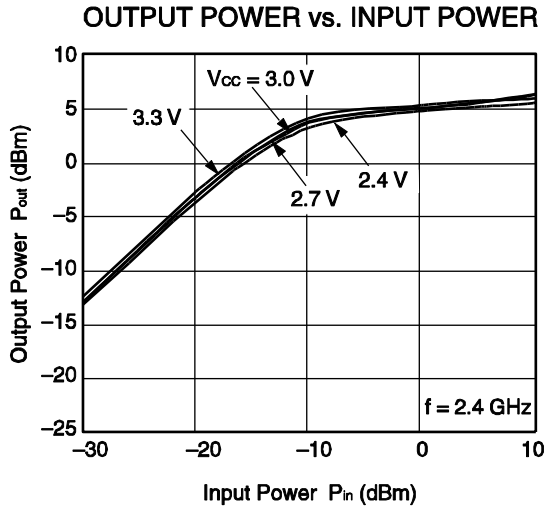

**Remark** The graphs indicate nominal characteristics.

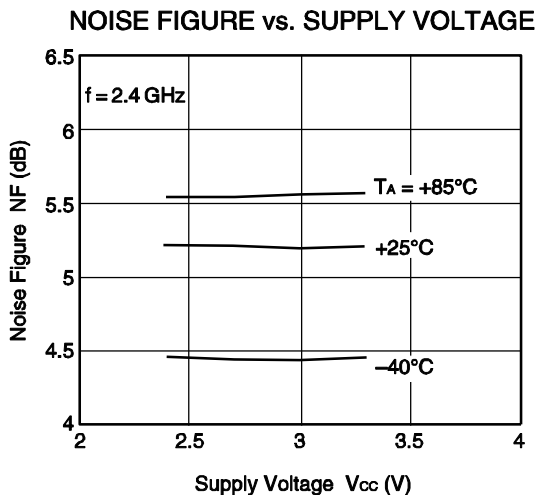
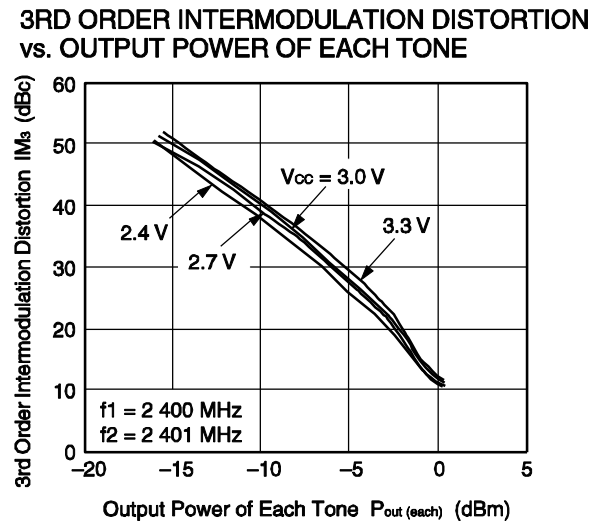
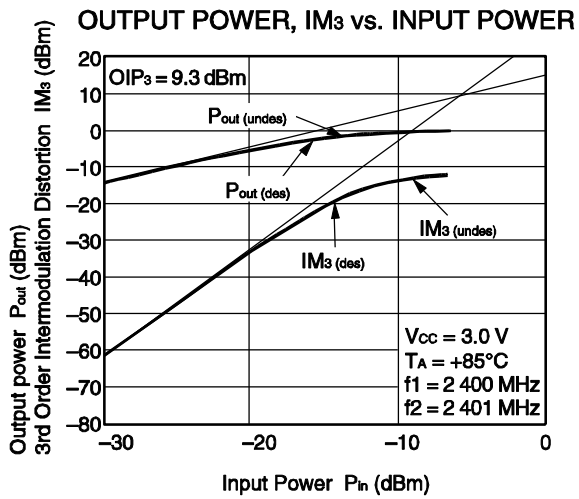
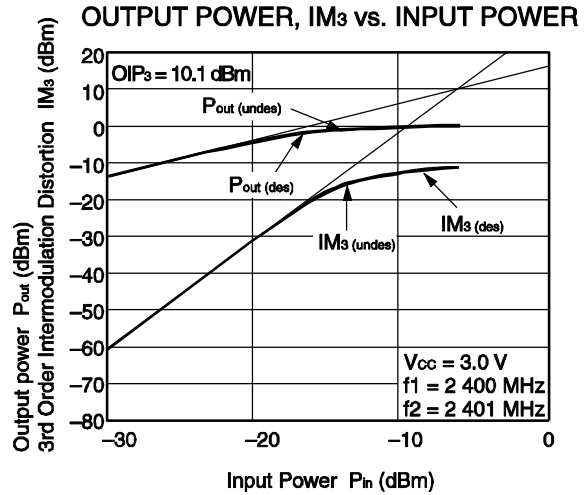
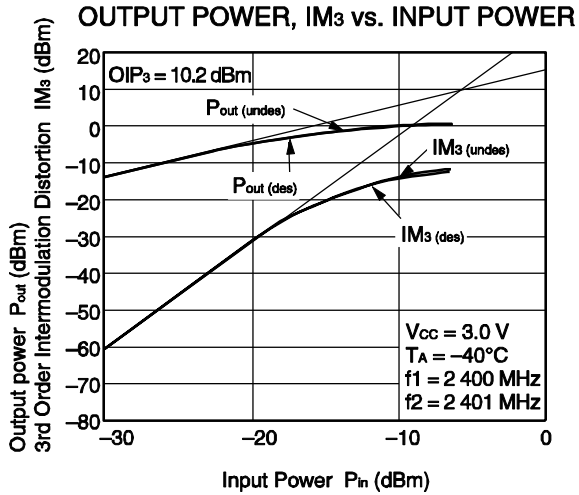

**Remark** The graphs indicate nominal characteristics.

f = 3.0 GHz MATCHING

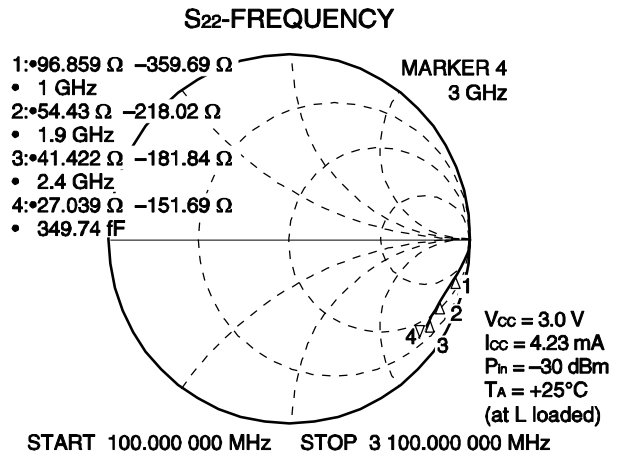
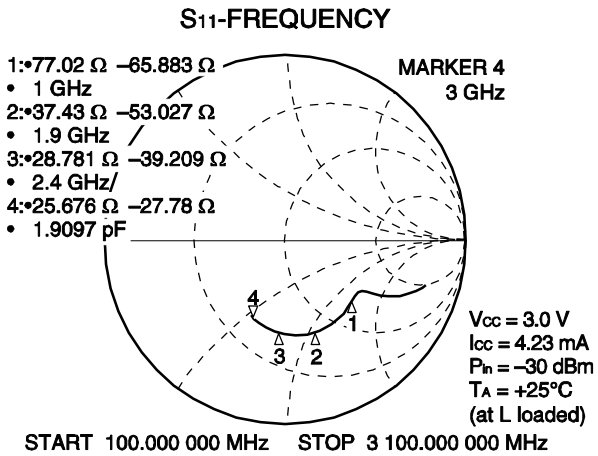

Remark The graphs indicate nominal characteristics.

PACKAGE DIMENSIONS

6-PIN LEAD-LESS MINIMOLD (1511) (UNIT: mm)

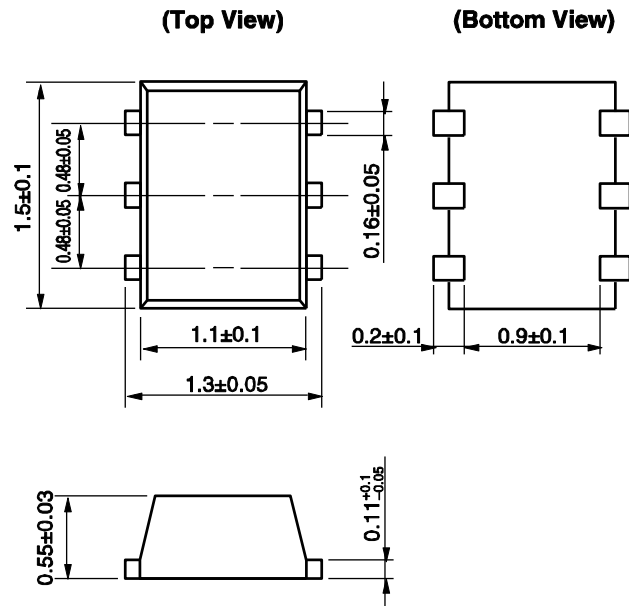



**NOTE ON CORRECT USE**

- (1) Observe precautions for handling because of electro-static sensitive devices.
- (2) Form a ground pattern as widely as possible to minimize ground impedance (to prevent undesired oscillation). All the ground pins must be connected together with wide ground pattern to decrease impedance difference.
- (3) The bypass capacitor should be attached to V<sub>cc</sub> line.
- (4) The inductor (L) should be attached between output and V<sub>cc</sub> pins. The L and series capacitor (C) values should be adjusted for applied frequency to match impedance to next stage.
- (5) The DC capacitor must be attached to input pin.



**RECOMMENDED SOLDERING CONDITIONS**

This product should be soldered and mounted under the following recommended conditions. For soldering methods and conditions other than those recommended below, contact your nearby sales office.

Soldering Method	Soldering Conditions	Condition Symbol
Infrared Reflow	Peak temperature (package surface temperature) : 260°C or below Time at peak temperature : 10 seconds or less Time at temperature of 220°C or higher : 60 seconds or less Preheating time at 120 to 180°C : 120±30 seconds Maximum number of reflow processes : 3 times Maximum chlorine content of rosin flux (% mass) : 0.2%(Wt.) or below	IR260
Wave Soldering	Peak temperature (molten solder temperature) : 260°C or below Time at peak temperature : 10 seconds or less Preheating temperature (package surface temperature) : 120°C or below Maximum number of flow processes : 1 time Maximum chlorine content of rosin flux (% mass) : 0.2%(Wt.) or below	WS260
Partial Heating	Peak temperature (terminal temperature) : 350°C or below Soldering time (per side of device) : 3 seconds or less Maximum chlorine content of rosin flux (% mass) : 0.2%(Wt.) or below	HS350

**Caution Do not use different soldering methods together (except for partial heating).**

## Данный компонент на территории Российской Федерации

### Вы можете приобрести в компании MosChip.

Для оперативного оформления запроса Вам необходимо перейти по данной ссылке:

<http://moschip.ru/get-element>

Вы можете разместить у нас заказ для любого Вашего проекта, будь то серийное производство или разработка единичного прибора.

В нашем ассортименте представлены ведущие мировые производители активных и пассивных электронных компонентов.

Нашей специализацией является поставка электронной компонентной базы двойного назначения, продукции таких производителей как XILINX, Intel (ex.ALTERA), Vicor, Microchip, Texas Instruments, Analog Devices, Mini-Circuits, Amphenol, Glenair.

Сотрудничество с глобальными дистрибьюторами электронных компонентов, предоставляет возможность заказывать и получать с международных складов практически любой перечень компонентов в оптимальные для Вас сроки.

На всех этапах разработки и производства наши партнеры могут получить квалифицированную поддержку опытных инженеров.

Система менеджмента качества компании отвечает требованиям в соответствии с ГОСТ Р ИСО 9001, ГОСТ РВ 0015-002 и ЭС РД 009

### Офис по работе с юридическими лицами:

105318, г.Москва, ул.Щербаковская д.3, офис 1107, 1118, ДЦ «Щербаковский»

Телефон: +7 495 668-12-70 (многоканальный)

Факс: +7 495 668-12-70 (доб.304)

E-mail: [info@moschip.ru](mailto:info@moschip.ru)

Skype отдела продаж:

moschip.ru

moschip.ru\_4

moschip.ru\_6

moschip.ru\_9