



Features

- Dual Channel VGA
- Frequency Range 400MHz to 2700MHz
- Full Internal Matching and No External Bias Inductors
- Two 6-Bit Digital Step Attenuators
- 12-Bit SPI Serial Control Programming
- High Channel Isolation = 50dBc
- Max Gain = 18.5dB at 900MHz
- Gain Control Range = 31.5dB (0.5dB Step Size)
- High OIP3/P1dB = +37dBm/19dBm at 900MHz
- Single + 5V Supply
- Small 32-Pin, 7.0mm x 7.0mm, MCM
- Power-up Programming

Applications

- Cellular, 3G Infrastructure
- WiBro, WiMAX, LTE
- Microwave Radio
- High Linearity Power Control

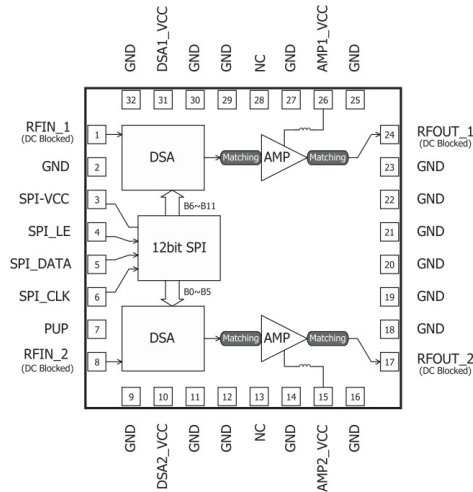

Functional Block Diagram

Product Description

RFMD's RFDA0057 is a dual-channel, digital controlled variable gain amplifier featuring high linearity over the entire gain control range with noise figure less than 7dB in its maximum gain state. The gains of two 6-bit digital step attenuators are programmed with a serial mode control interface (SPI). The RFDA0057 is packaged in a small 7.0mm x 7.0mm leadless laminate MCM, which contains plated through thermal vias for ultra-low thermal resistance. This module is easy to use with no external matching components required.

Ordering Information

RFDA0057SR	7" Sample reel with 100 pieces
RFDA0057SQ	Sample bag with 25 pieces
RFDA0057TR7	7" Reel with 750 pieces
RFDA0057TR13	13" Reel with 2500 pieces
RFDA0057PCK-410	400MHz to 2700MHz PCBA with 5-piece sample bag

Optimum Technology Matching® Applied

- | | | | |
|-----------------------------------------------|--------------------------------------|------------------------------------------------|------------------------------------|
| <input type="checkbox"/> GaAs HBT | <input type="checkbox"/> SiGe BiCMOS | <input checked="" type="checkbox"/> GaAs pHEMT | <input type="checkbox"/> GaN HEMT |
| <input type="checkbox"/> GaAs MESFET | <input type="checkbox"/> Si BiCMOS | <input checked="" type="checkbox"/> Si CMOS | <input type="checkbox"/> BIFET HBT |
| <input checked="" type="checkbox"/> InGaP HBT | <input type="checkbox"/> SiGe HBT | <input type="checkbox"/> Si BJT | <input type="checkbox"/> SOI |

RF MICRO DEVICES®, RFMD®, Optimum Technology Matching®, Enabling Wireless Connectivity™, PowerStar®, POLARIS™ TOTAL RADIO™ and UltimateBlue™ are trademarks of RFMD, LLC. BLUETOOTH is a trademark owned by Bluetooth SIG, Inc., U.S.A. and licensed for use by RFMD. All other trade names, trademarks and registered trademarks are the property of their respective owners. ©2012, RF Micro Devices, Inc.

Absolute Maximum Ratings

Parameter	Rating	Unit
Supply Voltage	+5.5	V _{DC}
DS Supply Current	205	mA
Power Dissipation	1100	mW
Maximum Input RF Power	24	dBm
Operating Temperature (T _{CASE})	-40 to +85	°C
Storage Temperature	-40 to +150	°C
Junction Temperature	165	°C
ESD Rating (HBM)	1000 (Class 1C)	V
Moisture Sensitivity Level	MSL 3	

MTTF = 1.0E6 hours at 165 °C junction temperature



Caution! ESD sensitive device.

Exceeding any one or a combination of the Absolute Maximum Rating conditions may cause permanent damage to the device. Extended application of Absolute Maximum Rating conditions to the device may reduce device reliability. Specified typical performance or functional operation of the device under Absolute Maximum Rating conditions is not implied.

RoHS status based on EU Directive 2011/65/EU (at time of this document revision).

The information in this publication is believed to be accurate and reliable. However, no responsibility is assumed by RF Micro Devices, Inc. ("RFMD") for its use, nor for any infringement of patents, or other rights of third parties, resulting from its use. No license is granted by implication or otherwise under any patent or patent rights of RFMD. RFMD reserves the right to change component circuitry, recommended application circuitry and specifications at any time without prior notice.



RFMD Green: RoHS compliant per EU Directive 2011/65/EU, halogen free per IEC 61249-2-21, < 1000 ppm each of antimony trioxide in polymeric materials and red phosphorus as a flame retardant, and <2% antimony in solder.

Parameter	Specification			Unit	Condition
	Min.	Typ.	Max.		
Overall					Temp = 25 °C, V _{CC} = V _{DD} = 5V, standard application circuit
Frequency	400		2700	MHz	
Max Gain		18.5		dB	Attenuation = 0dB
Gain Control Range		31.5		dB	
Step Accuracy	+/- (0.15+5% attenuation setting)			dB	Major state error up to 2700MHz
P1dB		19		dBm	Attenuation = 0dB at 900MHz
Output IP3		37		dBm	P _{OUT} = 0dBm/tone, 1MHz spacing at 900MHz
Control Interface		12		bit	SPI interface
Settling Time		250		ns	t _{ON} , t _{OFF} (10%/90% RF)
Noise Figure		7		dB	Attenuation = 0dB
Channel-to-Channel Isolation		50		dB	Input at RFIN1 (or RFIN2), the isolation between two outputs
Impedance		50		Ω	
Input Return Loss		-15		dB	900MHz
Output Return Loss		-15		dB	900MHz
Total Supply Voltage	4.75	5.0	5.25	V	
Supply Current		155		mA	From V _{CC-SPI} , V _{CC-AMP1} and V _{CC-AMP2}
Thermal Resistance		40		°C/W	Junction to backside of device

Typical RF Performance at Key Operating Frequencies

Parameter	Unit	700MHz	900MHz	1700MHz	2300MHz	2500MHz	2700MHz
Max Small Signal Gain	dB	18.5	18.5	18	17.5	17.5	17.5
Output P1dB	dBm	19	19	19	19	18.5	18.5
Output IP3*	dBm	38	37	34.5	32.5	32	31.5
Noise Figure	dB	5.7	5.7	6.5	7	6.9	7.2

*Note: OIP3 is tested at P_{OUT} = 0dBm/Tone and 1MHz spacing

Typical Broadband Performance $V_{CC} = 5.0V$, $I_{CC} = 155mA$

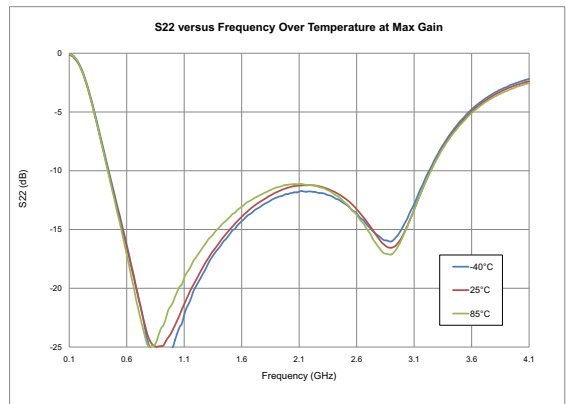
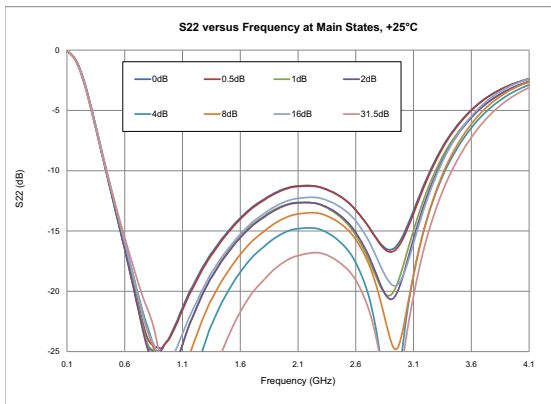
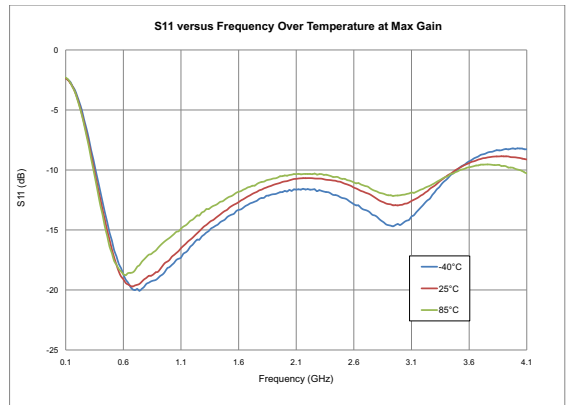
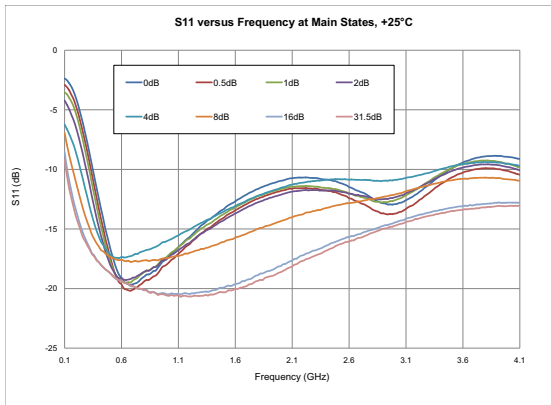
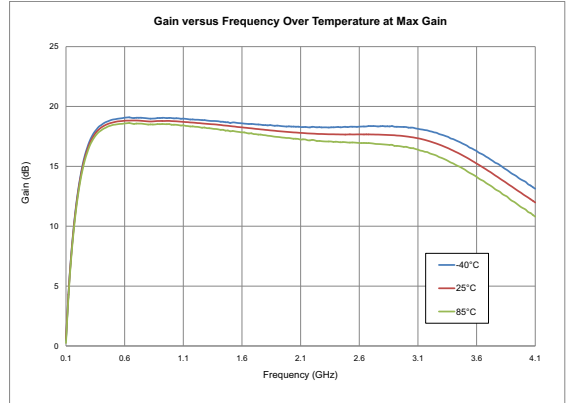
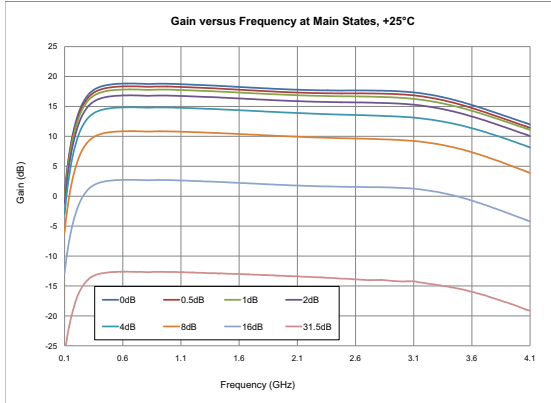

Typical Broadband Performance $V_{CC} = 5.0V$, $I_{CC} = 155mA$

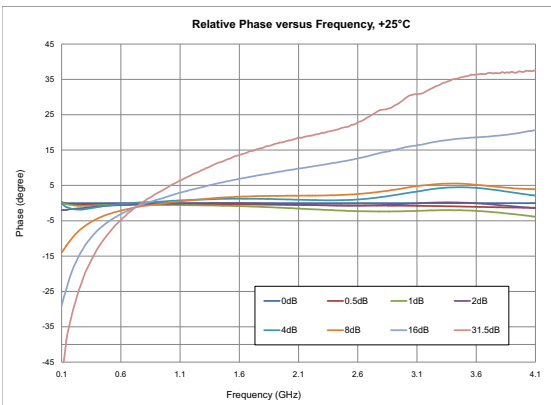
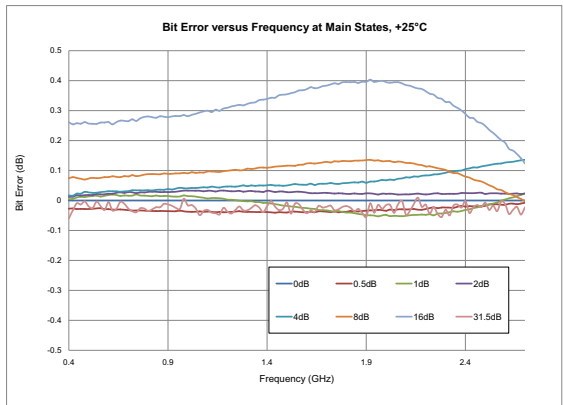
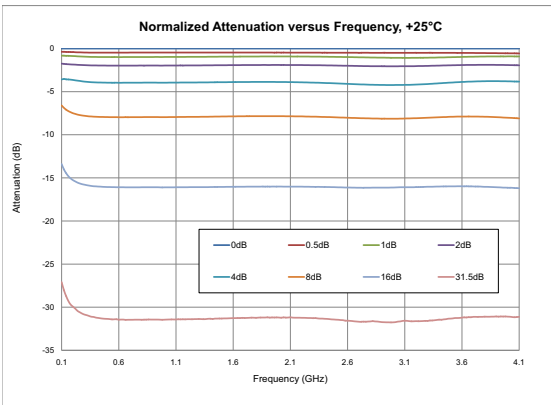
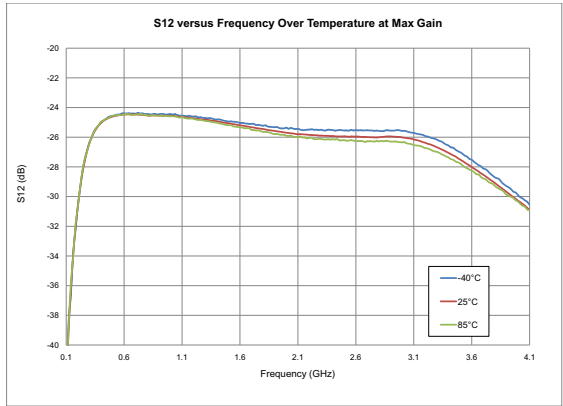
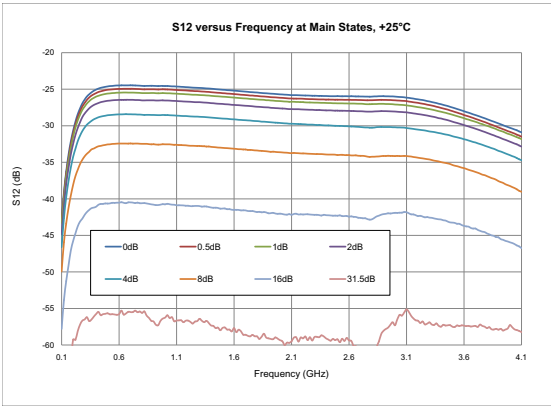

Typical Broadband Performance $V_{CC} = 5.0V$, $I_{CC} = 155mA$

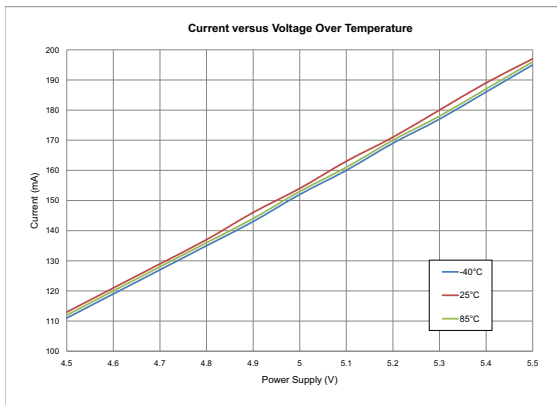
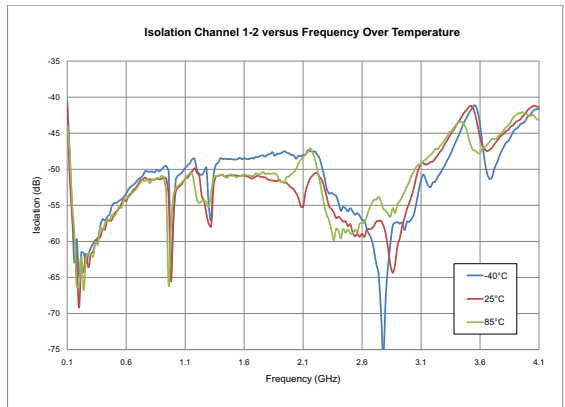
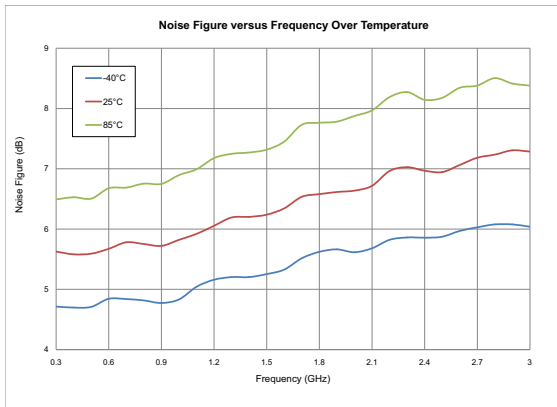
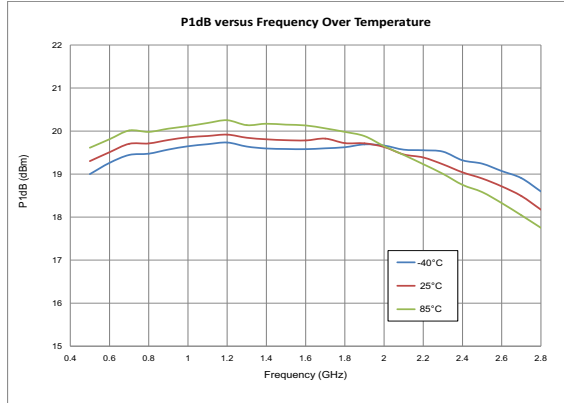
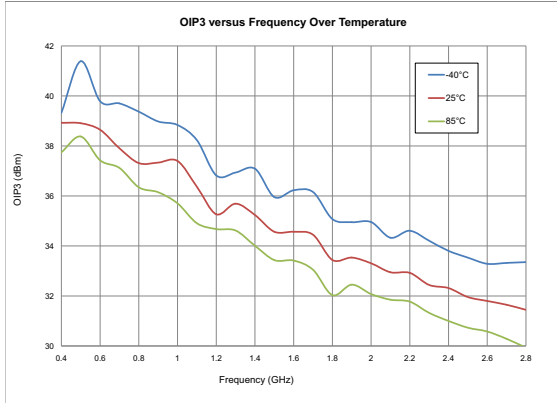

Truth Table

Channel 1 Control Bit						Gain Relative to Maximum Gain
D11	D10	D9	D8	D7	D6	
1	1	1	1	1	1	0dB
1	1	1	1	1	0	-0.5dB
1	1	1	1	0	1	-1dB
1	1	1	0	1	1	-2dB
1	1	0	1	1	1	-4dB
1	0	1	1	1	1	-8dB
0	1	1	1	1	1	-16dB
0	0	0	0	0	0	-31.5dB

Channel 2 Control Bit						Gain Relative to Maximum Gain
D5	D4	D3	D2	D1	D0	
1	1	1	1	1	1	0dB
1	1	1	1	1	0	-0.5dB
1	1	1	1	0	1	-1dB
1	1	1	0	1	1	-2dB
1	1	0	1	1	1	-4dB
1	0	1	1	1	1	-8dB
0	1	1	1	1	1	-16dB
0	0	0	0	0	0	-31.5dB

Power-up Programming Truth Table	
PUP	Attenuator Setting
High	Attenuation at min, 0dB
Low	Attenuation at max, 31.5dB

Logic Voltage Levels	
State	Logic
Low	0V to 0.8V
High	2.0V to 5.0V

Serial Port Interface

SPI Timing Diagram

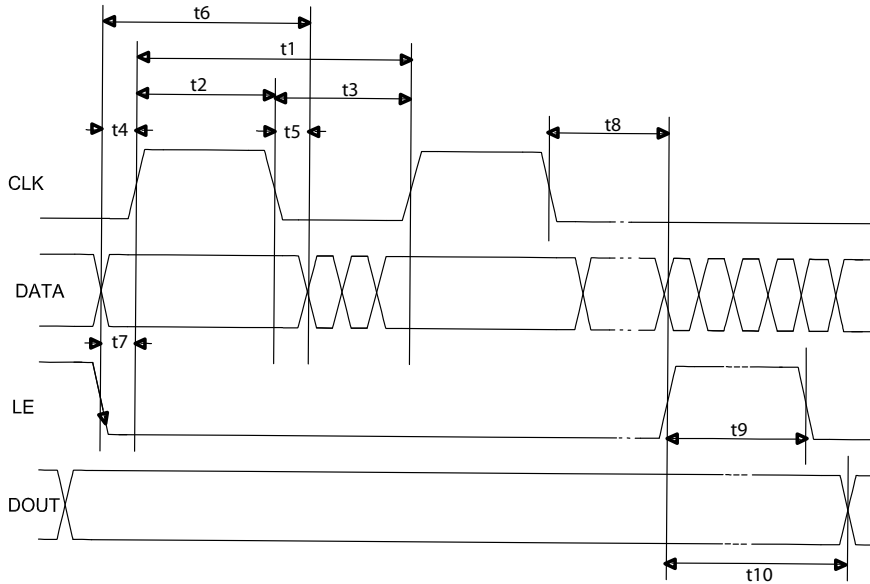

Programming Example - 12 Bit

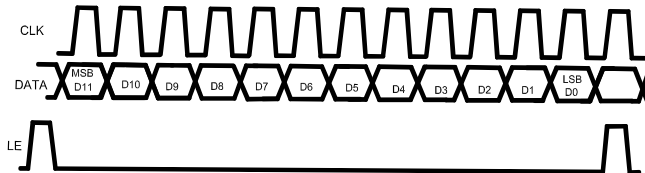

SPI Timing Diagram Specifications

Parameter	Limit	Unit	Comment
t1	25	MHz max	CLK Frequency
t2	20	ns min	CLK High
t3	20	ns min	CLK Low
t4	5	ns min	DATA to CLK Setup Time
t5	5	ns min	DATA to CLK Hold Time
t6	30	ns min	DATA Valid
t7	5	ns min	LE to CLK Setup Time
t8	5	ns min	CLK to LE Setup Time
t9	10	ns min	LE Pulse Width
t10	20	ns max	Output Set

Pin Names and Descriptions

Pin	Name	Description
1	RFIN_1	AMP 1 RF Input
2	GND	RF/DC Ground Connection
3	SPI_VCC	Supply Voltage for SPI Chip
4	SPI_LE	Serial Latch Enable Input
5	SPI_DATA	Serial Data Input
6	SPI_CLK	Serial Clock Input
7	PUP	Power-up Programming Pin
8	RFIN_2	AMP 2 RF Input
9	GND	RF/DC Ground Connection
10	DSA2_VCC	Supply Voltage for DSA2 Chip
11	GND	RF/DC Ground Connection
12	GND	RF/DC Ground Connection
13	NC	No Connect
14	GND	RF/DC Ground Connection
15	AMP2_VCC	Supply Voltage for Amplifier 2
16	GND	RF/DC Ground Connection
17	RFOUT_2	AMP 2 RF Output
18	GND	RF/DC Ground Connection
19	GND	RF/DC Ground Connection
20	GND	RF/DC Ground Connection
21	GND	RF/DC Ground Connection
22	GND	RF/DC Ground Connection
23	GND	RF/DC Ground Connection
24	RFOUT_1	AMP 1 RF Output
25	GND	RF/DC Ground Connection
26	AMP1_VCC	Supply Voltage for Amplifier 1
27	GND	RF/DC Ground Connection
28	NC	No Connect
29	GND	RF/DC Ground Connection
30	GND	RF/DC Ground Connection
31	DSA1_VCC	Supply Voltage for DSA1 Chip
32	GND	RF/DC Ground Connection

Evaluation Schematic - 400MHz to 2700MHz Application Circuit

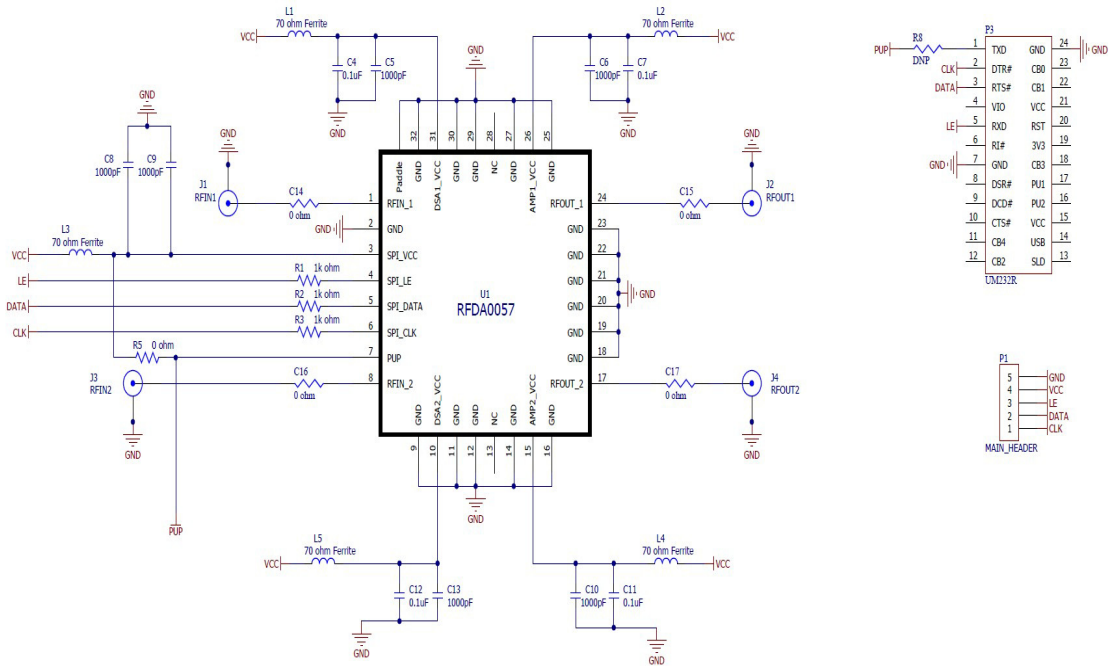

Evaluation Board Build of Materials 400MHz to 2700MHz Application Circuit

Description	Reference Designator	Manufacturer	Manufacturer's P/N
RFDAx0x7, PCB		DDI	RFDAx0x7410
RFDA0057SB	U1	RFMD	RFDA0057
RES, 0Ω, 0402	C14-C17, R5	Kamaya, Inc	RMC1/16SJPTH
CAP, 1000pF, 10%, 50V, X7R, 0402	C1-C3, C5-C6, C8-C10, C13	Murata Electronics	GRM155R71H102KA01E
CAP, 0.1μF, 10%, 16V, X7R, 0603	C4, C7, C11-C12	Murata Electronics	GRM188R71C104KA01D
FER, BEAD, 70Ω, 4A, 0603	L1-L5	Murata Electronics	BLM18SG700TN1D
RES, 1K, 5%, 1/16W, 0402	R1-R3	KOA Speer	RK73B1ETTP102J
CONN, SMA, END LNCH, RND PIN, 0.059"	J1-J4	Gigalane	PSF-S01-006
CONN, HDR, ST, PLRZD, 5-PIN, 0.100"	P1	ITW Pancon	MPSS100-5-C

Evaluation Board Assembly Drawing 400MHz to 2700MHz Application Circuit

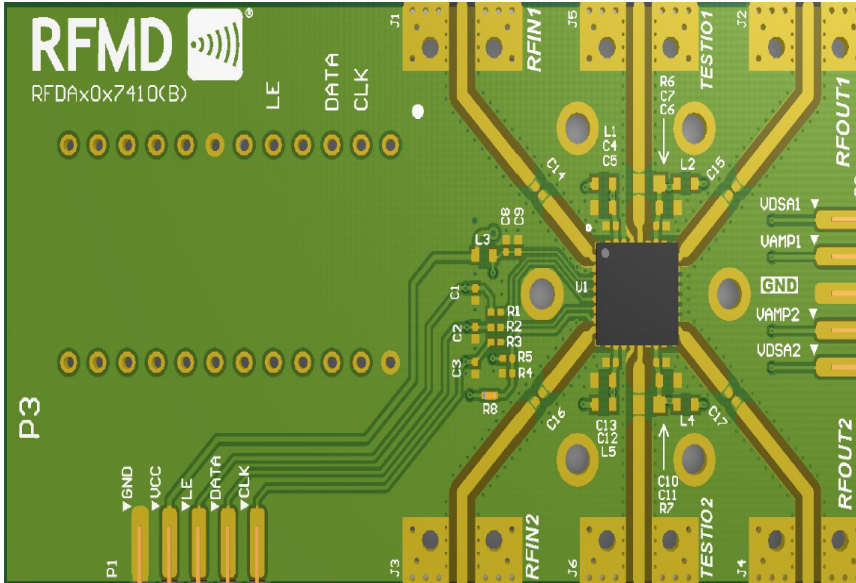

Package Drawing 7.0mm x 7.0mm Laminate Module

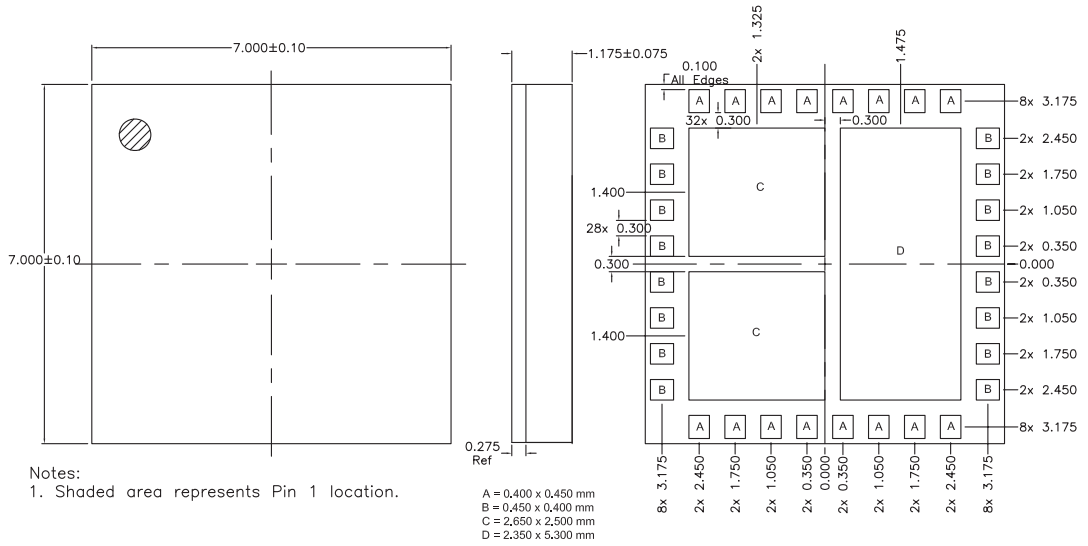

Branding Drawing

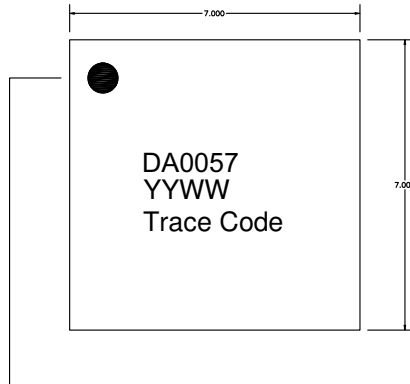

Pin 1 Indicator

Fill in the YYWW Notation with the Date Code

YY = Year

WW = Week

Trace Code to be assigned by SubCon

Данный компонент на территории Российской Федерации

Вы можете приобрести в компании MosChip.

Для оперативного оформления запроса Вам необходимо перейти по данной ссылке:

<http://moschip.ru/get-element>

Вы можете разместить у нас заказ для любого Вашего проекта, будь то серийное производство или разработка единичного прибора.

В нашем ассортименте представлены ведущие мировые производители активных и пассивных электронных компонентов.

Нашей специализацией является поставка электронной компонентной базы двойного назначения, продукции таких производителей как XILINX, Intel (ex.ALTERA), Vicor, Microchip, Texas Instruments, Analog Devices, Mini-Circuits, Amphenol, Glenair.

Сотрудничество с глобальными дистрибьюторами электронных компонентов, предоставляет возможность заказывать и получать с международных складов практически любой перечень компонентов в оптимальные для Вас сроки.

На всех этапах разработки и производства наши партнеры могут получить квалифицированную поддержку опытных инженеров.

Система менеджмента качества компании отвечает требованиям в соответствии с ГОСТ Р ИСО 9001, ГОСТ РВ 0015-002 и ЭС РД 009

Офис по работе с юридическими лицами:

105318, г.Москва, ул.Щербаковская д.3, офис 1107, 1118, ДЦ «Щербаковский»

Телефон: +7 495 668-12-70 (многоканальный)

Факс: +7 495 668-12-70 (доб.304)

E-mail: info@moschip.ru

Skype отдела продаж:

moschip.ru

moschip.ru_4

moschip.ru_6

moschip.ru_9