

Round Water-resistant Connectors (M12)

XS2

Water- and Environment-resistive FA Connectors Save Wiring and Maintenance Effort

- Compact FA connectors satisfy IP67 requirements and ensure a 94V-0 fire retardant rating.
- A wide array of connectors makes a wiring system more modular, simplifies maintenance, and reduces downtime.
- Connectors with Cables and Connector Assemblies are available.
- Three types of Connector Assembly: Crimping, soldering, and screw-on.



■ Ratings and Specifications

| Item | 4,5 Poles | 8 Poles |
|--|--------------------------------------|---------------------|
| Rated current | 4 A | 1.5 A |
| Rated voltage | 125 VDC, 250 VAC | 36 VDC |
| Contact resistance | 40 mΩ max. (20 mV max., 100 mA max.) | |
| Insulation resistance | 1,000 MΩ min. (at 500 VDC) | |
| Dielectric strength (leakage current: 1 mA max.) | 1,500 VAC for 1 min | 1,000 VAC for 1 min |
| Degree of protection | IP67 (IEC60529) | |
| Insertion tolerance | 200 times min. | |

■ Material

| | |
|--------------------|---------------------------------------|
| Contact / Surface | Copper Alloy / Nickel base, Au 0.4 μm |
| Connector housing | PBT resin (UL94V-0) |
| Nut / Surface | Copper Alloy / Nickel plated |
| Cover (XS2F/H/W/R) | PBT resin (UL94V-0) |
| Body (XS2C/G) | PBT resin (UL94V-0) |

■ PVC Cable

| Item | 3 cores | 4 cores | 5 cores | 8 cores |
|-------------------|--|-------------|-------------|-----------------------------------|
| Color | Black | | | Light Grey |
| Outer diameter | 5 mm dia. | 5.4 mm dia. | 5.8 mm dia. | 6 mm dia. |
| Conductor size | AWG22 0.34 mm ² (43 × 0.1) | | | 0.25 mm ² (20 × 0.127) |
| Approvals | AWM | | | — |
| Features | Flame retardant | | | — |
| Temperature range | Cable fixed: -10 to +80°C / Cable moved: -0 to +60°C | | | -25°C to +70°C |

■ PVC Cable (For IP69K)

| Item | Standard | Heat-resistant |
|-------------------|--|---------------------------------------|
| Color | Light Gray | Black |
| Outer diameter | 6 mm dia. | |
| Conductor size | AWG20 0.5 mm ² (100 × 0.08) | AWG20 0.5 mm ² (45 × 0.12) |
| Approvals | CL3 | — |
| Features | Flame retardant | Heat and chemical resistant |
| Temperature range | -25 to +70°C | -25 to +105°C |

■ PUR Cable

| Item | 3 cores | 4 cores | 5 cores |
|-------------------|---|-------------|-----------|
| Color | Black | | |
| Outer diameter | 4.3 mm dia. | 4.7 mm dia. | 5 mm dia. |
| Conductor size | AWG22 0.34 mm ² (43 × 0.1) | | |
| Approvals | AWM | | |
| Features | Flame retardant Halogen free Oil resistance | | |
| Temperature range | Cable fixed: -50 to +80°C / Cable moved: -25 to +80°C | | |

■ Construction

(XS2G Soldering Plug Connector Assembly)

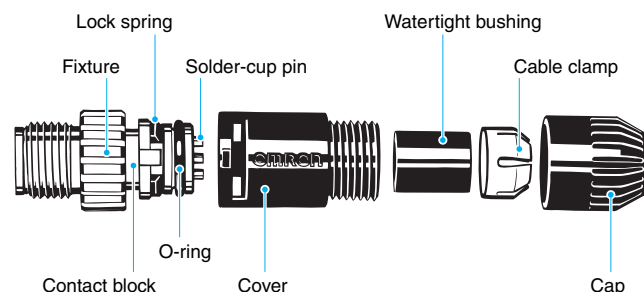

Note: 1. See "XS5/XS2 - Assembly Tooling and Accessories" datasheet for information regarding assembly, tooling and accessories that are common to the XS5 and XS2 connectors

2. See "XS5" datasheet for specifics regarding those connectors

4-Pin and 5-Pin Connectors with Cable Attached

■ XS2F - Socket on One Cable End

XS2F-M12PVC□□□□M PVC Cable
 XS2F-M12PUR□□□□M PUR Cable



Dimensions

(Unit: mm)

Straight



Angled



Wiring Diagram

| 3 cores | 4 cores | 5 cores |
|---------|---------|---------|
| | | |

Ordering Information

| Connector | Size | Cable material | Cores | Shape | Length (m) | Product description |
|-----------|----------|----------------|------------------|------------------|------------------|---------------------|
| Socket | M12 | PVC | 3 | Angled | 2 | XS2F-M12PVC3A2M |
| | | | | | 5 | XS2F-M12PVC3A5M |
| | | | | | 10 | XS2F-M12PVC3A10M |
| | | | | Straight | 2 | XS2F-M12PVC3S2M |
| | | | | | 5 | XS2F-M12PVC3S5M |
| | | | | | 10 | XS2F-M12PVC3S10M |
| | | | 4 | Angled | 2 | XS2F-M12PVC4A2M |
| | | | | | 5 | XS2F-M12PVC4A5M |
| | | | | | 10 | XS2F-M12PVC4A10M |
| | | | | Straight | 2 | XS2F-M12PVC4S2M |
| | | | | | 5 | XS2F-M12PVC4S5M |
| | | | | | 10 | XS2F-M12PVC4S10M |
| | | | 5 | Angled | 2 | XS2F-M12PVC5A2M |
| | | | | | 5 | XS2F-M12PVC5A5M |
| | | | | | 10 | XS2F-M12PVC5A10M |
| | | Straight | | 2 | XS2F-M12PVC5S2M | |
| | | | | 5 | XS2F-M12PVC5S5M | |
| | | | | 10 | XS2F-M12PVC5S10M | |
| | | PUR | 3 | Angled | 2 | XS2F-M12PUR3A2M |
| | | | | | 5 | XS2F-M12PUR3A5M |
| | | | | | 10 | XS2F-M12PUR3A10M |
| | | | | Straight | 2 | XS2F-M12PUR3S2M |
| | | | | | 5 | XS2F-M12PUR3S5M |
| | | | | | 10 | XS2F-M12PUR3S10M |
| | | | 4 | Angled | 2 | XS2F-M12PUR4A2M |
| | | | | | 5 | XS2F-M12PUR4A5M |
| | | | | | 10 | XS2F-M12PUR4A10M |
| | | | | Straight | 2 | XS2F-M12PUR4S2M |
| | | | | | 5 | XS2F-M12PUR4S5M |
| | | | | | 10 | XS2F-M12PUR4S10M |
| 5 | Angled | | 2 | XS2F-M12PUR5A2M | | |
| | | | 5 | XS2F-M12PUR5A5M | | |
| | | | 10 | XS2F-M12PUR5A10M | | |
| | Straight | 2 | XS2F-M12PUR5S2M | | | |
| | | 5 | XS2F-M12PUR5S5M | | | |
| | | 10 | XS2F-M12PUR5S10M | | | |

Model Number Legend

Use this model number legend to identify products from their model number. When ordering, use a model number from the table in *Ordering Information*.

XS2F - M12 **M**

1 2 3 4 5

1. Screw Type

M12: M12 size

2. Cable type

PVC: PVC cable

PUR: PUR cable

3. Number of Poles

3: 3 cores

4: 4 cores

5: 5 cores

4. Shape

A: Angled

S: Straight

5. Cable Length

2M: 2 m

5M: 5 m

10M: 10 m

■ XS2F - Socket on One Cable End with LED

XS2F-M12PVC□□□□MLED PVC Cable
 XS2F-M12PUR□□□□MLED PUR Cable



Dimensions

(Unit: mm)

Angled

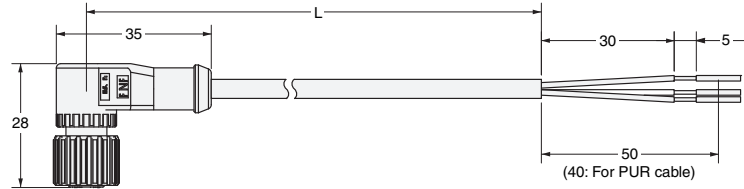

Wiring Diagram

3 poles

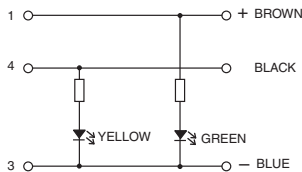

4 poles



Ordering Information

| Connector Type | Shape | Size | Number of Poles | Cable Material | Cable Length (M) | Model | |
|----------------|--------|------|-----------------|----------------|------------------|---------------------|---------------------|
| Socket | Angled | M12 | 3 | PVC | 2 | XS2F-M12PVC3A2MLED | |
| | | | | | 5 | XS2F-M12PVC3A5MLED | |
| | | | | | 10 | XS2F-M12PVC3A10MLED | |
| | | | | | 4 | 2 | XS2F-M12PVC4A2MLED |
| | | | | | | 5 | XS2F-M12PVC4A5MLED |
| | | | | | | 10 | XS2F-M12PVC4A10MLED |
| | | | 3 | PUR | 2 | XS2F-M12PUR3A2MLED | |
| | | | | | 5 | XS2F-M12PUR3A5MLED | |
| | | | | | 10 | XS2F-M12PUR3A10MLED | |
| | | | | | 4 | 2 | XS2F-M12PUR4A2MLED |
| | | | | | | 5 | XS2F-M12PUR4A5MLED |
| | | | | | | 10 | XS2F-M12PUR4A10MLED |

Model Number Legend

Use this model number legend to identify products from their model number. When ordering, use a model number from the table in *Ordering Information*.

XS2F - M12 □□□□ A □□ M LED
 1 2 3 4 5 6

1. Screw Type

M12: M12 size

2. Cable type

PVC: PVC cable

PUR: PUR cable

3. Number of Poles

3: 3 cores

4: 4 cores

4. Shape

A: Angled

5. Cable Length

2M: 2 m

5M: 5 m

10M: 10 m

6. LED

LED: with LED

■ XS2F - Sockets on One Cable End with IP69K rating

Dimensions

Straight



Angled

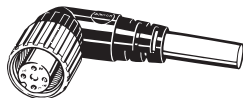

Wiring Diagram



Ordering Information

| Connector | Size | Cable material | Cores | Shape | Length (m) | Product description |
|-----------|------|-----------------------------|-------|----------|-----------------|---------------------|
| Socket | M12 | Vibration Proof Robot Cable | 4 | Angled | 2 | XS2F-E422-D80-F |
| | | | | | 5 | XS2F-E422-G80-F |
| | | | | | 10 | XS2F-E422-J80-F |
| | | | | Straight | 2 | XS2F-E421-D80-F |
| | | | | | 5 | XS2F-E421-G80-F |
| | | | | | 10 | XS2F-E421-J80-F |
| | | Angled | | 2 | XS2F-E422-D80-E | |
| | | | | 5 | XS2F-E422-G80-E | |
| | | | | 10 | XS2F-E422-J80-E | |
| | | Straight | | 2 | XS2F-E421-D80-E | |
| | | | | 5 | XS2F-E421-G80-E | |
| | | | | 10 | XS2F-E421-J80-E | |

Note: XS2F-E42□ models with -F are cRUus approved

Model Number Legend

Use this model number legend to identify products from their model number. When ordering, use a model number from the table in *Ordering Information*.

XS2F - E42□ - □80 - □
1 2 3 4 5 6 7 8

- | | | |
|--|--|---|
| <p>1. Nut Material E: Stainless</p> <p>2. Number of Poles 4: 4 cores</p> <p>3. Contact Plating 2: 0.4-μm gold plating</p> | <p>4. Shape 1: Straight 2: Angled</p> <p>5. Cable Length D: 2 m G: 5 m J: 10 m</p> | <p>6. Connections 8: Brown, White, Blue, Black</p> <p>7. Connectors on One End/Both Ends 0: One End</p> <p>8. Cable Specification F: Vibration Proof Robot Cable E: Heat-resistant cable</p> |
|--|--|---|

■ XS2H - Plugs on One Cable End

XS2H-M12PVC□□S□□M PVC Cable
 XS2H-M12PUR□□S□□M PUR Cable



Dimensions

(Unit: mm)

Straight



Wiring Diagram

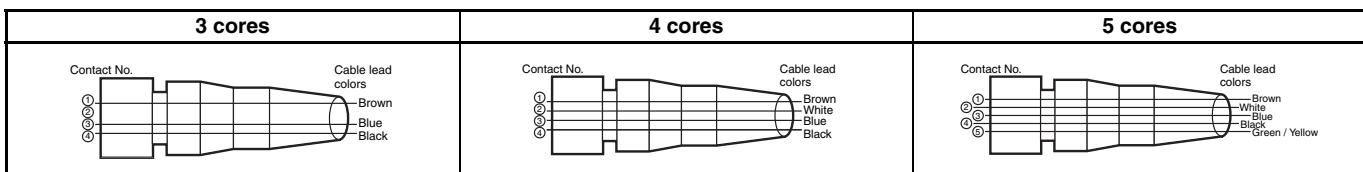

Ordering Information

| Connector | Size | Cable material | Cores | Shape | Length (m) | Product description | | |
|-----------|------|----------------|------------------|----------|------------------|---------------------|----|------------------|
| Plug | M12 | PVC | 3 | Straight | 2 | XS2H-M12PVC3S2M | | |
| | | | | | 5 | XS2H-M12PVC3S5M | | |
| | | | | | 10 | XS2H-M12PVC3S10M | | |
| | | | 4 | | 2 | XS2H-M12PVC4S2M | | |
| | | | | | 5 | XS2H-M12PVC4S5M | | |
| | | | | | 10 | XS2H-M12PVC4S10M | | |
| | | 5 | 2 | | XS2H-M12PVC5S2M | | | |
| | | | 5 | | XS2H-M12PVC5S5M | | | |
| | | | 10 | | XS2H-M12PVC5S10M | | | |
| | | PUR | 3 | | PUR | Straight | 2 | XS2H-M12PUR3S2M |
| | | | | | | | 5 | XS2H-M12PUR3S5M |
| | | | | | | | 10 | XS2H-M12PUR3S10M |
| | | | 4 | | | | 2 | XS2H-M12PUR4S2M |
| | | | | | | | 5 | XS2H-M12PUR4S5M |
| | | | | | | | 10 | XS2H-M12PUR4S10M |
| 5 | 2 | | XS2H-M12PUR5S2M | | | | | |
| | 5 | | XS2H-M12PUR5S5M | | | | | |
| | 10 | | XS2H-M12PUR5S10M | | | | | |

Model Number Legend

Use this model number legend to identify products from their model number. When ordering, use a model number from the table in *Ordering Information*.

XS2H - M12 □□□□ □S □□M
 1 2 3 4 5

1. Screw Type

M12: M12 size

2. Cable type

PVC: PVC cable

PUR: PUR cable

3. Number of Poles

3: 3 cores

4: 4 cores

5: 5 cores

4. Shape

S: Straight

5. Cable Length

2M: 2 m

5M: 5 m

10M: 10 m

■ XS2W - Socket and Plug on Cable Ends

XS2W-M12PVC□SS□□M PVC Cable
 XS2W-M12PUR□SS□□M PUR Cable



Dimensions

(Unit: mm)

Straight/Straight



Wiring Diagram



Ordering Information

| Connector | Size | Cable material | Cores | Shape | | Length (m) | Product description |
|-----------|------|----------------|-------|----------|----------|------------|---------------------|
| | | | | Plug | Socket | | |
| Both | M12 | PVC | 4 | Straight | Straight | 2 | XS2W-M12PVC4SS2M |
| | | | | | | 5 | XS2W-M12PVC4SS5M |
| | | | | | | 10 | XS2W-M12PVC4SS10M |
| | | | 5 | | | 2 | XS2W-M12PVC5SS2M |
| | | | | | | 5 | XS2W-M12PVC5SS5M |
| | | | | | | 10 | XS2W-M12PVC5SS10M |
| | | PUR | 4 | | | 2 | XS2W-M12PUR4SS2M |
| | | | | | | 5 | XS2W-M12PUR4SS5M |
| | | | | | | 10 | XS2W-M12PUR4SS10M |
| | | | 5 | | | 2 | XS2W-M12PUR5SS2M |
| | | | | | | 5 | XS2W-M12PUR5SS5M |
| | | | | | | 10 | XS2W-M12PUR5SS10M |

Model Number Legend

Use this model number legend to identify products from their model number. When ordering, use a model number from the table in *Ordering Information*.

XS2W - M12 □□□ □SS □□M
 1 2 3 4 5

1. Screw Type

M12: M12 size

2. Cable type

PVC: PVC cable

PUR: PUR cable

3. Number of Poles

4: 4 cores

5: 5 cores

4. Shape

SS: Straight / Straight

5. Cable Length

2M: 2 m

5M: 5 m

1M: 10 m

4-Pin and 5-Pin Assembly Connector

■ XS2C - Sockets, Crimping / Soldering Terminals



Dimensions

(Unit: mm)

XS2C-□4C□ (Crimping Model)

XS2C-□42□ (Soldering Model)

Straight

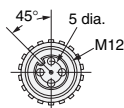

Angled

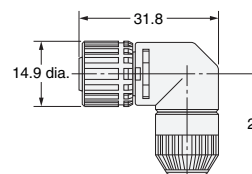
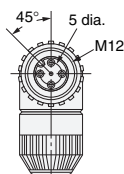

Ordering Information

| Suitable cable dia. (mm) | Cable connection direction | Connection method | Model | Minimum order |
|-------------------------------------|----------------------------|-------------------|-----------|---------------|
| 6-mm-dia. model (5 to 6 mm dia.) | Straight | Crimping | XS2C-D4C1 | 50 |
| | | Soldering | XS2C-D421 | |
| | Angled | Crimping | XS2C-D4C2 | |
| | | Soldering | XS2C-D422 | |
| 4-mm-dia. model (4 to 5 mm dia.) | Straight | Crimping | XS2C-D4C3 | |
| | | Soldering | XS2C-D423 | |
| | Angled | Crimping | XS2C-D4C4 | |
| | | Soldering | XS2C-D424 | |
| 3-mm-dia. model (3 to 4 mm dia.) | Straight | Crimping | XS2C-D4C5 | |
| | | Soldering | XS2C-D425 | |
| | Angled | Crimping | XS2C-D4C6 | |
| | | Soldering | XS2C-D426 | |

Note: Crimping plug contacts are sold separately.

■ XS2U (Crimping Pin for XS2C)

Dimensions

(Unit: mm)

XS2U-222□ (Socket Pin)



Dimensions

| Model | Suitable core size (mm ²) | Dimension (mm) | | | No. of slits |
|-----------|---------------------------------------|----------------|-----|-----|--------------|
| | | A | B | C | |
| XS2U-2221 | 0.18 to 0.3 | 16.7 | 6.1 | 0.8 | 1 |
| XS2U-2222 | 0.5 to 0.75 | 16.8 | 6.2 | 1.3 | 0 |

Note: A special tool must be used for crimping. For details, refer to the "XS5/XS2 - Assembly Tooling and Accessories" datasheet.

Ordering Information

Note: Orders are accepted in multiples of the minimum order.

| Suitable core size (mm ²) | Model | Minimum order |
|---------------------------------------|-----------|---------------|
| 0.18 to 0.3 | XS2U-2221 | 100 |
| 0.5 to 0.75 | XS2U-2222 | |

■ XS2C - Sockets, Screw Terminals

Dimensions

(Unit: mm)

XS2C-D5S7 (5-core, Straight, Applicable Cable Outer Diameter: 8 mm)

XS2C-D5S9 (5-core, Straight, Applicable Cable Outer Diameter: 7 mm)

XS2C-D4S7 (4-core, Straight, Applicable Cable Outer Diameter: 8 mm)

XS2C-D4S9 (4-core, Straight, Applicable Cable Outer Diameter: 7 mm)



XS2C-D5S1 (5-core, Straight, Applicable Cable Outer Diameter: 6 mm)

XS2C-D4S□ (4-core, Straight, Applicable Cable Outer Diameter: 3, 4, or 6 mm)



XS2C-D5S2 (5-core, Angled, Applicable Cable Outer Diameter: 6 mm)

XS2C-D4S□ (4-core, Angled, Applicable Cable Outer Diameter: 3, 4, or 6 mm)

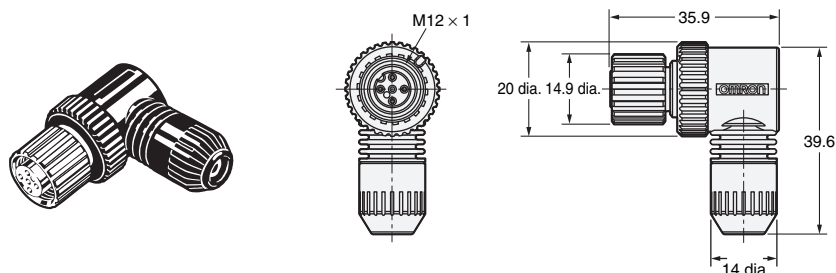

Ordering Information

| No. of poles | Suitable cable dia. (mm) | Straight connectors | | Angled connectors | | Minimum order |
|--------------|----------------------------------|---------------------|------------------|-------------------|-------|---------------|
| | | Model | Model | Model | Model | |
| 5 | 8-mm-dia. model (7 to 8 mm dia.) | XS2C-D5S7 | — | — | — | 50 |
| | 7-mm-dia. model (6 to 7 mm dia.) | XS2C-D5S9 | — | — | — | |
| | 6-mm-dia. model (5 to 6 mm dia.) | XS2C-D5S1 | XS2C-D5S2 | — | — | |
| 4 | 8-mm-dia. model (7 to 8 mm dia.) | XS2C-D4S7 | — | — | — | |
| | 7-mm-dia. model (6 to 7 mm dia.) | XS2C-D4S9 | — | — | — | |
| | 6-mm-dia. model (5 to 6 mm dia.) | XS2C-D4S1 | XS2C-D4S2 | — | — | |
| | 4-mm-dia. model (4 to 5 mm dia.) | XS2C-D4S3 | XS2C-D4S4 | — | — | |
| | 3-mm-dia. model (3 to 4 mm dia.) | XS2C-D4S5 | XS2C-D4S6 | — | — | |

■ XS2G - Plugs, Crimping / Soldering Terminals

(Unit: mm)

Dimensions

XS2G-□4C□ (Crimping Model)

XS2G-□42□ (Soldering Model)

Straight

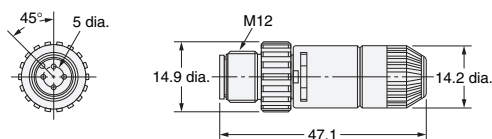

XS2G-D42□ (Soldering Model)

Angled

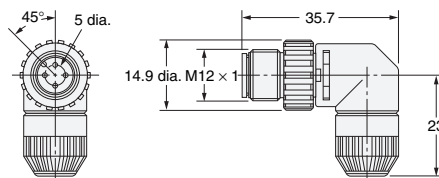
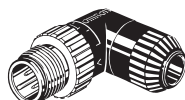

Ordering Information

| Suitable cable dia. (mm) | Cable connection direction | Connection method | Model | Minimum order |
|-------------------------------------|----------------------------|-------------------|-----------|---------------|
| 6-mm-dia. model (5 to 6 mm dia.) | Straight | Crimping | XS2G-D4C1 | 50 |
| | | Soldering | XS2G-D421 | |
| 4-mm-dia. model (4 to 5 mm dia.) | Straight | Crimping | XS2G-D4C3 | |
| | | Soldering | XS2G-D423 | |
| | Angled | Soldering | XS2G-D424 | |
| 3-mm-dia. model (3 to 4 mm dia.) | Straight | Crimping | XS2G-D4C5 | |
| | | Soldering | XS2G-D425 | |
| | Angled | Soldering | XS2G-D426 | |

Note: Crimping plug contacts are sold separately.

■ XS2U (Crimping Pin for XS2G)

Dimensions

(Unit: mm)

XS2U-312□ (Plug Pin)

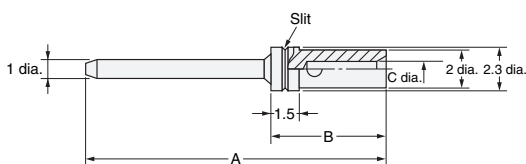

Dimensions

| Model | Suitable core size (mm ²) | Dimension (mm) | | | No. of slits |
|-----------|---------------------------------------|----------------|-----|-----|--------------|
| | | A | B | C | |
| XS2U-3121 | 0.18 to 0.3 | 20.0 | 6.1 | 0.8 | 1 |
| XS2U-3122 | 0.5 to 0.75 | 20.1 | 6.2 | 1.3 | 0 |

Note: A special tool must be used for crimping. For details, refer to the "XS5/XS2 - Assembly Tooling and Accessories" datasheet.

Ordering Information

Note: Orders are accepted in multiples of the minimum order.

| Suitable core size (mm ²) | Model | Minimum order |
|---------------------------------------|-----------|---------------|
| 0.18 to 0.3 | XS2U-3121 | 100 |
| 0.5 to 0.75 | XS2U-3122 | |

■ XS2G - Plugs, Screw Terminals

Dimensions

(Unit: mm)

XS2G-D5S7 (5-core, Straight, Applicable Cable Outer Diameter: 8 mm)

XS2G-D5S9 (5-core, Straight, Applicable Cable Outer Diameter: 7 mm)

XS2G-D4S7 (4-core Straight, Applicable Cable Outer Diameter: 8 mm)

XS2G-D4S9 (4-core Straight, Applicable Cable Outer Diameter: 7 mm)



XS2G-D5S1 (5-core Straight, Applicable Cable Outer Diameter: 6 mm)

XS2G-D4S□ (4-core, Straight, Applicable Cable Outer Diameter: 3, 4, or 6 mm)



XS2G-D5S2 (5-core, Angled, Applicable Cable Outer Diameter: 6 mm)

XS2G-D4S□ (4-core, Angled, Applicable Cable Outer Diameter: 3, 4, or 6 mm)



Ordering Information

| No. of poles | Suitable cable dia. (mm) | Straight connectors | | Angled connectors | | Minimum order |
|--------------|----------------------------------|---------------------|--|-------------------|--|---------------|
| | | Model | | Model | | |
| 5 | 8-mm-dia. model (7 to 8 mm dia.) | XS2G-D5S7 | | — | | 50 |
| | 7-mm-dia. model (6 to 7 mm dia.) | XS2G-D5S9 | | — | | |
| | 6-mm-dia. model (5 to 6 mm dia.) | XS2G-D5S1 | | XS2G-D5S2 | | |
| 4 | 8-mm-dia. model (7 to 8 mm dia.) | XS2G-D4S7 | | — | | |
| | 7-mm-dia. model (6 to 7 mm dia.) | XS2G-D4S9 | | — | | |
| | 6-mm-dia. model (5 to 6 mm dia.) | XS2G-D4S1 | | XS2G-D4S2 | | |
| | 4-mm-dia. model (4 to 5 mm dia.) | XS2G-D4S3 | | XS2G-D4S4 | | |
| | 3-mm-dia. model (3 to 4 mm dia.) | XS2G-D4S5 | | XS2G-D4S6 | | |

Note: XS2G Screw terminal Plugs cannot be connected to side by side to the CN1 and CN2 connectors of XS2R Y-Joint Sockets/Plugs.

Y-Joint 4-Pin Plug/Socket Connectors

■ XS2R

Dimensions

(Unit: mm)

XS2R-D426-□11-F

Connectors on Both Cable Ends (Y-Joint Plug/Socket)



Wiring Diagram



XS2R-D426-□10-F

Connectors on One Cable End (Y-Joint Plug/Socket)



Wiring Diagram



XS2R-D426-1

Y-Joint Plug/Socket without Cable



Wiring Diagram

XS2R-D426-1

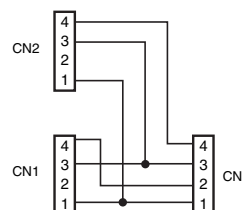

XS2R-D426-5

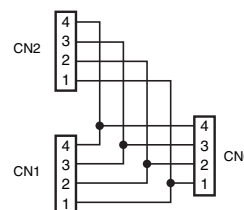

XS2R-D426-81

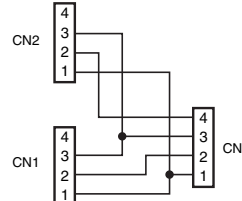

XS2R-D426-82

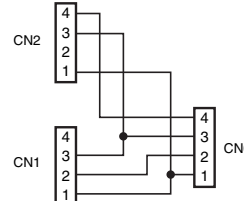

Ordering Information

| Type | Connector | Cable length L (m) | Model | Minimum order |
|---------------|-------------------------------|--------------------|-----------------|---------------|
| With cable | Connectors on both cable ends | 0.5 | XS2R-D426-B11-F | 5 |
| | | 1 | XS2R-D426-C11-F | |
| | | 2 | XS2R-D426-D11-F | |
| | | 3 | XS2R-D426-E11-F | |
| | Connector on one cable end | 2 | XS2R-D426-D10-F | |
| | | 5 | XS2R-D426-G10-F | |
| Without cable | Y-Joint plug/socket | — | XS2R-D426-1 | 10 |
| | | — | XS2R-D426-5 | |
| | | — | XS2R-D426-81 | |
| | | — | XS2R-D426-82 | |

Note: XS2G Screw-on Plugs cannot be connected side-by-side to the CN1 and CN2 connectors. Consider using a crimping or soldering model instead.

T-Joint Plug/Socket Connectors

■ XS2R

Dimensions

XS2R-D422-1
 XS2R-D422-5
 Aggregate Models



(Unit: mm)

Wiring Diagram
 XS2R-D422-1



XS2R-D422-5



XS2R-D423-1
 Bifurcated Model



Wiring Diagram



XS2R-D424-1
 Daisy-chain Model



Wiring Diagram

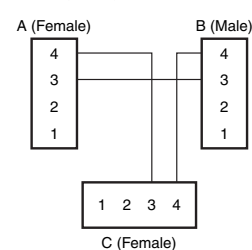

Ordering Information

| Type | Model | Minimum order |
|-------------------|-------------|---------------|
| Aggregate model | XS2R-D422-1 | 20 |
| | XS2R-D422-5 | |
| Bifurcated model | XS2R-D423-1 | |
| Daisy-chain model | XS2R-D424-1 | |

Safety Precautions

■ Correct Use - XS2R

Do not use this product under ambient conditions that exceed the ratings.
 Before using the XS2R for Sensors, make sure that the wiring of the Sensors and the internal connections of the XS2R are correct.
 See the end of this datasheet for XS2R Application examples.
 See "XS5/XS2 - Assembly Tooling and Accessories" datasheet for information regarding assembly, tooling and accessories that are common to the XS5 and XS2 connectors

Panel-mount Connectors

■ XS2P - Sockets

Dimensions

(Unit: mm)

XS2P-D421-2 (with Solder Cup Pins)
Rear Lock Model



XS2P-D422-1 (with Through-hole PCB Pins)
XS2P-D422-2 (with Solder Cup Pins)
Front Lock Model



Note: The panel thickness is 1 to 4 mm.



Ordering Information

| Lock method | Pin shape | Model | Minimum order |
|-------------|----------------------|-------------|---------------|
| Rear lock | Solder cup pin | XS2P-D421-2 | 50 |
| Front lock | Solder cup pin | XS2P-D422-2 | |
| | Through-hole PCB pin | XS2P-D422-1 | |

■ XS2M - Plugs

Dimensions

(Unit: mm)

XS2M-D423
(Flange-mounting Model)

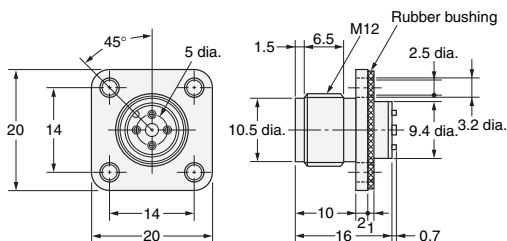

Panel Cutouts



XS2M-D424-1 (With PCB Pins)
XS2M-D424-2 (With Solder Cup Pins)
(Screw-mounting Model)

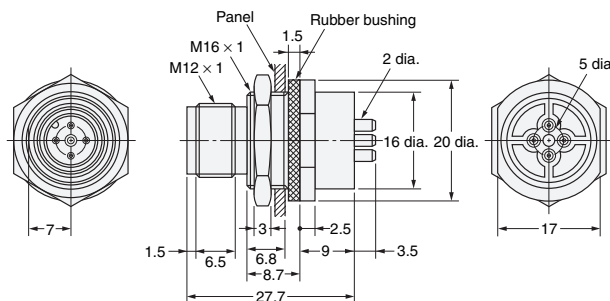
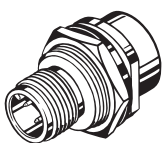

Panel Cutouts



Note: The panel thickness is 1 to 4 mm.

PCB-mounting Dimensions

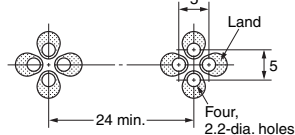

Connectors for Embedding in Sensors

■ XS2M - Plugs

Dimensions

(Unit: mm)

XS2M-D421
(Embedded Plug with Screw Threads)



Mounted Dimensions



Note: After mounting, anchor the solder cups by injecting resin.

XS2M-D422
(Embedded Plug without Screw Threads)



Mounted Dimensions



Note: After mounting, anchor the solder cups by injecting resin.

8-Pin Connector with Cable Attached/Panel-mount

■ XS2 □

Ordering Information

| Connector type | Cable connection direction | Number of cores | Cable length (m) | Model |
|-------------------------------|----------------------------|-----------------|------------------|-----------------|
| Panel-mounting socket | — | — | — | XS2P-D821-2 |
| | | | | XS2P-D822-2 |
| Panel-mounting plug | | | | XS2M-D824-4 |
| Plug on one cable end | Straight | 8 | 0.3 | XS2H-D821-AH0-C |
| | | | 1 | XS2H-D821-CH0-C |
| Socket on one cable end | | | 2 | XS2F-D821-DH0-C |
| | | | 5 | XS2F-D821-GH0-C |
| Plug and socket on cable ends | | | 2 | XS2W-D821-DH1-C |
| | 5 | XS2W-D821-GH1-C | | |

Pin Numbers and Cable Lead Colors

| XS2F/XS2H/XS2W cable lead colors | Pin number | | | | | | | |
|----------------------------------|------------|-------|-------|--------|------|------|------|--------|
| | 1 | 2 | 3 | 4 | 5 | 6 | 7 | 8 |
| | White | Brown | Green | Yellow | Gray | Pink | Blue | Shield |

Wiring Example



Dimensions

XS2H Plug on One Cable End (M12)

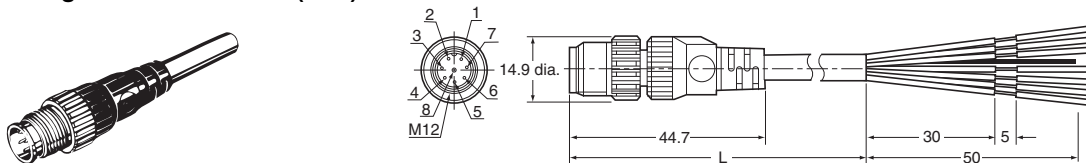

XS2F Socket on One Cable End (M12)

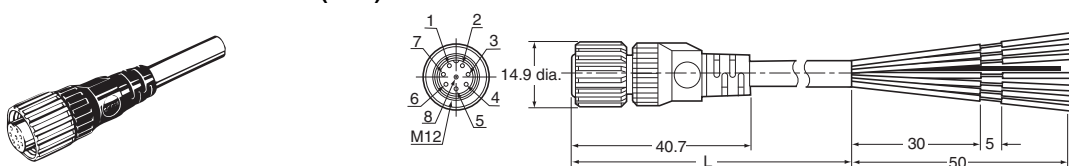

XS2W Plug and Socket on Cable Ends (M12)

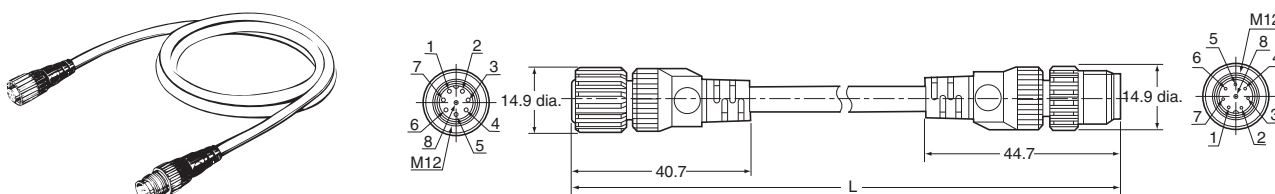

XS2P-D821-2 Panel-mounting Socket (M12) with Solder Cup Pins and Rear Lock

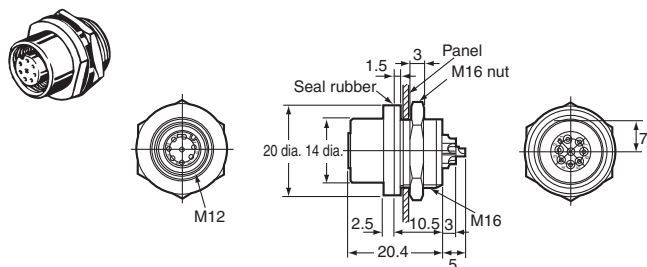

XS2M-D824-4 Panel-mounting Plug (M12) with Solder Cup Pins and Front Lock

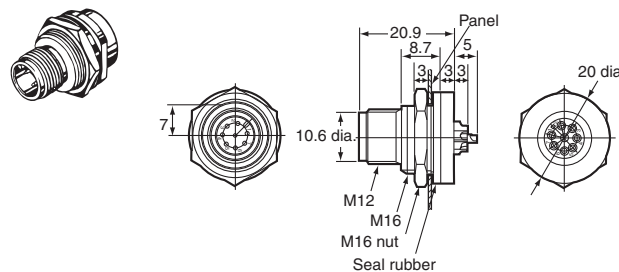

XS2P-D822-2 Panel-mounting Socket (M12) with Solder Cup Pins and Front Lock

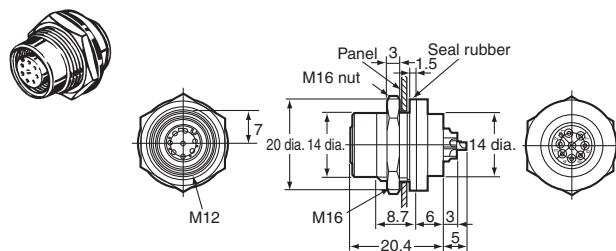

Panel Cutouts

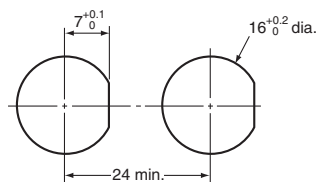

Connector Pin Numbers (from Mating Side)

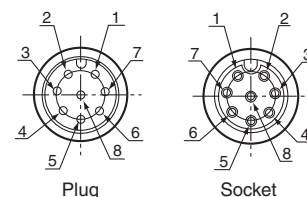

- Note:**
1. Mounting panel thickness: 1 to 4 mm.
 2. Applicable core wire size for solder cup pins: 0.5 mm² max.
 3. The M16 nut and seal rubber are included.

Ordering Information

| Mounting method | Pin shape | Model | Minimum order |
|--------------------------------|----------------------|-------------|---------------|
| Embedded with screw threads | Solder cup pin | XS2M-D421 | 50 |
| Embedded with no screw threads | | XS2M-D422 | |
| Flange-mounting | | XS2M-D423 | |
| Screw-mounting | Through-hole PCB pin | XS2M-D424-1 | |
| | Solder cup pin | XS2M-D424-2 | |

XS2R Application Examples

XS2R-D422-1 (Aggregate Model)



- A pair of Two-wire Sensors or Three-wire Sensors can be connected as shown in the illustration.
- The XS2R-D422-5 has feedthrough connections, thus working as a connector for the extension cable.



XS2R-D423-1 (Bifurcated Model)



- Two or Three-wire Sensor signals can be bifurcated.



XS2R-D424-1 (Daisy Chain Model)

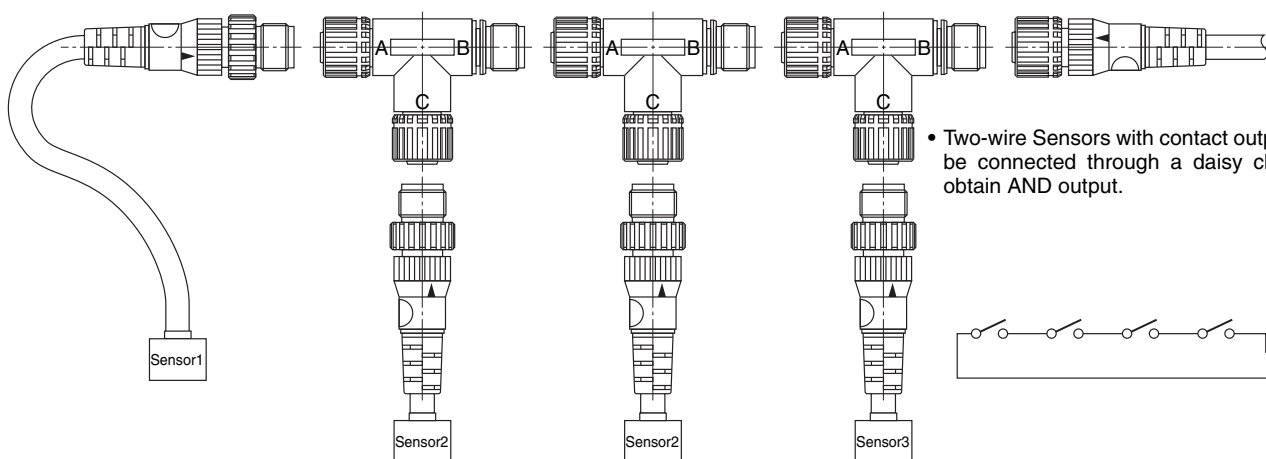

- Two-wire Sensors with contact output can be connected through a daisy chain to obtain AND output.

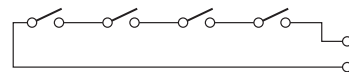

List of XS2 Products - Summary

| Name | Model | | Appearance |
|---|---|--------------------------------------|---|
| 1.Connectors attached to Cable | XS2W Sockets and Plugs on Cable Ends | |  |
| | XS2F Sockets on One Cable End | |  |
| | XS2H Plugs on One Cable End | |  |
| 2.Connector Assemblies (Crimping, Soldering, or Screw-on) Used to enable using connectors for sensor cables and relay cables. | XS2G Plug Assemblies | |  |
| | XS2C Socket Assemblies | |  |
| | XY2F Crimp Tool (for Crimping Connectors) | |  |
| | XW4Z Screwdriver (for Screw-on Connectors) | |  |
| 3.Terminal Box Connectors Used to enable using connectors for terminal boxes. | XS2P Panel-mounting Sockets | |  |
| 4.T-Joints and Y-Joints Used for branching and for daisy-chain connections. | XS2R T-Joint/Y-Joint Plug/Socket Connectors | T-Joints |  |
| | | Y-Joints |  |
| 5.Sensor Connector Assemblies Used to enable using connectors in sensors. | XS2M Plugs | Embedded Plugs with Screw Threads |  |
| | | Embedded Plugs with No Screw Threads |  |
| 6. Panel-mounting Connectors Used to enable using I/O box connectors mounted to panels. | XS2M Plugs | Flange-mounting Plugs |  |
| | | Screw-mounting Plugs |  |

Note: 1. See "XS5/XS2 - Assembly Tooling and Accessories" datasheet for information regarding assembly, tooling and accessories that are common to the XS5 and XS2 connectors
 2. See "XS5" datasheet for specifics regarding those connectors

All sales are subject to Omron Electronic Components LLC standard terms and conditions of sale, which can be found at http://www.components.omron.com/components/web/webfiles.nsf/sales_terms.html

ALL DIMENSIONS SHOWN ARE IN MILLIMETERS.

To convert millimeters into inches, multiply by 0.03937. To convert grams into ounces, multiply by 0.03527.

OMRON[®]

**OMRON ELECTRONIC
COMPONENTS LLC**

55 E. Commerce Drive, Suite B
Schaumburg, IL 60173

847-882-2288

OMRON ON-LINE

Global - <http://www.omron.com>

USA - <http://www.components.omron.com>

Cat. No. X304-E-1c

08/12

Specifications subject to change without notice

Printed in USA

Данный компонент на территории Российской Федерации

Вы можете приобрести в компании MosChip.

Для оперативного оформления запроса Вам необходимо перейти по данной ссылке:

<http://moschip.ru/get-element>

Вы можете разместить у нас заказ для любого Вашего проекта, будь то серийное производство или разработка единичного прибора.

В нашем ассортименте представлены ведущие мировые производители активных и пассивных электронных компонентов.

Нашей специализацией является поставка электронной компонентной базы двойного назначения, продукции таких производителей как XILINX, Intel (ex.ALTERA), Vicor, Microchip, Texas Instruments, Analog Devices, Mini-Circuits, Amphenol, Glenair.

Сотрудничество с глобальными дистрибьюторами электронных компонентов, предоставляет возможность заказывать и получать с международных складов практически любой перечень компонентов в оптимальные для Вас сроки.

На всех этапах разработки и производства наши партнеры могут получить квалифицированную поддержку опытных инженеров.

Система менеджмента качества компании отвечает требованиям в соответствии с ГОСТ Р ИСО 9001, ГОСТ РВ 0015-002 и ЭС РД 009

Офис по работе с юридическими лицами:

105318, г.Москва, ул.Щербаковская д.3, офис 1107, 1118, ДЦ «Щербаковский»

Телефон: +7 495 668-12-70 (многоканальный)

Факс: +7 495 668-12-70 (доб.304)

E-mail: info@moschip.ru

Skype отдела продаж:

moschip.ru

moschip.ru_4

moschip.ru_6

moschip.ru_9