

CM1693-04DE, CM1693-06DE, CM1693-08DE

L-C LCD and Camera EMI Filter Array with ESD Protection

Product Description

The CM1693 is a family of pi-style EMI filter arrays with ESD protection, which integrates four, six or eight filters (C-L-C) into a small-form factor, uDFN 0.40 mm pitch package. Each EMI filter channel is implemented as a 3-pole L-C filter, where the component values are 10 pF–26 nH–12 pF. The CM1693's roll-off frequency at –6 dB attenuation is 300 MHz and can be used in applications where the data rates are as high as 140 Mbps. The CM1693 also provides greater than –30 dB attenuation over the 800 MHz to 6 GHz frequency range. The device includes ESD diodes on every pin that provide a very high level of protection for sensitive electronic components against possible electrostatic discharge (ESD). The ESD protection diodes connected to the filter ports are designed and characterized to safely dissipate ESD strikes of ±18 kV, which is beyond the maximum requirement of the IEC61000–4–2 international standard.

This device is particularly well suited for wireless handsets, mobile LCD modules and PDAs because of its small package format and easy-to-use pin assignments. In particular, the CM1693 is ideal for EMI filtering and protecting data and control lines for the LCD display and camera interface in mobile handsets.

The CM1693 is housed in space saving, low profile, 0.40 mm pitch uDFN packages in a RoHS compliant, Pb-Free format.

Features

- 4, 6 or 8 Channels of EMI Filtering with Integrated ESD Protection
- Pi-Style EMI Filters in a Capacitor-Inductor-Capacitor (C-L-C) Network
- +18 kV ESD Protection on Each Channel (IEC 61000–4–2 Level 4, Contact Discharge)
- Greater than –35 dB Attenuation (Typical) at 1GHz
- uDFN Lead-Free Package with 0.40 mm Lead Pitch:
 - ◆ 4-Ch. = 8-Lead uDFN
 - ◆ 6-Ch. = 12-Lead uDFN
 - ◆ 8-Ch. = 16-Lead uDFN
- uDFN Package size:
 - ◆ 8-Lead: 1.70 mm x 1.35 mm
 - ◆ 12-Lead: 2.50 mm x 1.35 mm
 - ◆ 16-Lead: 3.30 mm x 1.35 mm
- Increased Robustness Against Vertical Impacts During Manufacturing Process

• These Devices are Pb-Free and are RoHS Compliant

Applications

- LCD and Camera Data Lines in Mobile Handsets
- I/O Port Protection for Mobile Handsets, Notebook Computers, PDAs etc.



ON Semiconductor®

<http://onsemi.com>

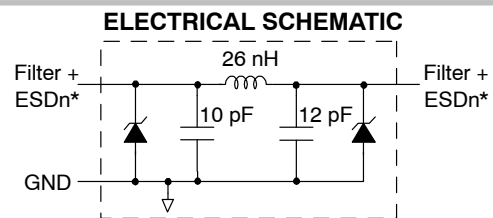
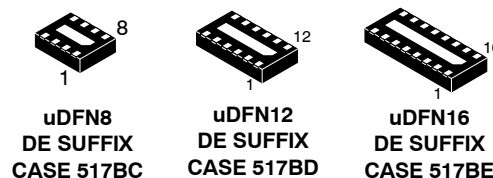

1 of 4, 6 or 8 EMI/RFI Filter Channels with Integrated ESD protection

* See Package/Pinout Diagram for expanded pin information

MARKING DIAGRAM

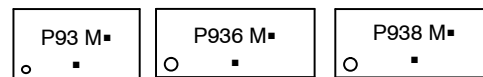

1 XXXX = Specific Device Code
 1 M = Month Code
 1 ■ = Pb-Free Package
 (*Note: Microdot may be in either location)

ORDERING INFORMATION

| Device | Package | Shipping† |
|-------------|-------------------|------------------|
| CM1693-04DE | uDFN-8 (Pb-Free) | 3000/Tape & Reel |
| CM1693-06DE | uDFN-12 (Pb-Free) | 3000/Tape & Reel |
| CM1693-08DE | uDFN-16 (Pb-Free) | 3000/Tape & Reel |

†For information on tape and reel specifications, including part orientation and tape sizes, please refer to our Tape and Reel Packaging Specification Brochure, BRD8011/D.

- Handheld PCs/PDAs
- LCD and Camera Modules
- EMI Filtering for Data Ports in Cell Phones, PDAs or Notebook Computers.
- Wireless Handsets

CM1693-04DE, CM1693-06DE, CM1693-08DE

Table 1. PIN DESCRIPTIONS

| Device Pin(s) | | | Name | Description |
|---------------|-------|-------|---------|------------------------|
| -04 | -06 | -08 | | |
| 1; 8 | 1; 12 | 1; 16 | FILTER1 | Filter + ESD Channel 1 |
| 2; 7 | 2; 11 | 2; 15 | FILTER2 | Filter + ESD Channel 2 |
| 3; 6 | 3; 10 | 3; 14 | FILTER3 | Filter + ESD Channel 3 |
| 4; 5 | 4; 9 | 4; 13 | FILTER4 | Filter + ESD Channel 4 |
| | 5; 8 | 5; 12 | FILTER5 | Filter + ESD Channel 5 |
| | 6; 7 | 6; 11 | FILTER6 | Filter + ESD Channel 6 |
| | | 7; 10 | FILTER7 | Filter + ESD Channel 7 |
| | | 8; 9 | FILTER8 | Filter + ESD Channel 8 |
| GND PAD | | | GND | Device Ground |

PACKAGE / PINOUT DIAGRAMS

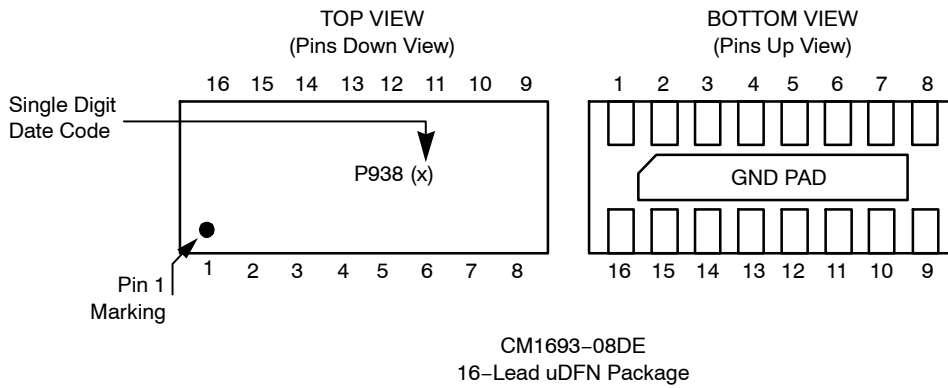
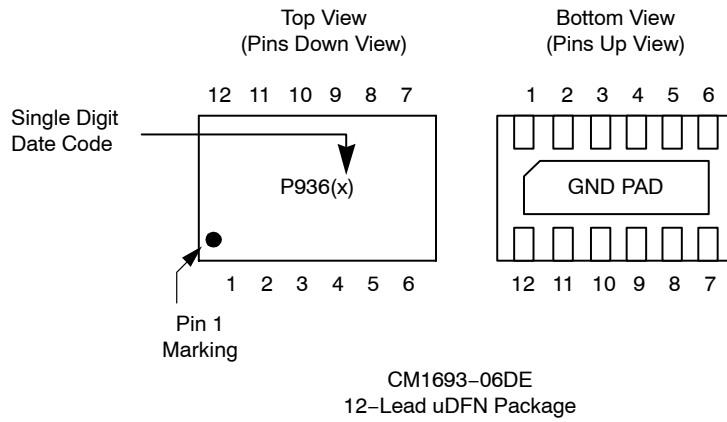
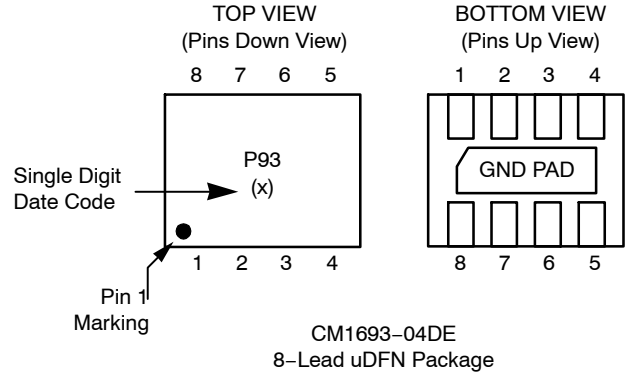

CM1693-04DE, CM1693-06DE, CM1693-08DE

SPECIFICATIONS

Table 2. ABSOLUTE MAXIMUM RATINGS

| Parameter | Rating | Units |
|---------------------------|-------------|-------|
| Storage Temperature Range | -65 to +150 | °C |
| Current per Inductor | 30 | mA |
| DC Package Power Rating | 500 | mW |

Stresses exceeding Maximum Ratings may damage the device. Maximum Ratings are stress ratings only. Functional operation above the Recommended Operating Conditions is not implied. Extended exposure to stresses above the Recommended Operating Conditions may affect device reliability.

Table 3. STANDARD OPERATING CONDITIONS

| Parameter | Rating | Units |
|-----------------------------|------------|-------|
| Operating Temperature Range | -40 to +85 | °C |

Table 4. ELECTRICAL OPERATING CHARACTERISTICS (Note 1)

| Symbol | Parameter | Conditions | Min | Typ | Max | Units |
|--------------------|---|---|-------------|-------------|-------------|-------|
| L | Channel Inductance | | | 26 | | nH |
| C _{TOTAL} | Total Channel Capacitance | At 2.5 VDC Reverse Bias, 1 MHz, 30 mVAC | 17.6 | 22 | 26.4 | pF |
| V _{DIODE} | Standoff Voltage | I _{DIODE} = 10 μA | 5.5 | | | V |
| I _{LEAK} | Diode Leakage Current (reverse bias) | V _{DIODE} = +3.3 V | | 0.1 | 1.0 | μA |
| V _{SIG} | Signal Clamp Voltage Positive Clamp Negative Clamp | I _{LOAD} = 10 mA I _{LOAD} = -10 mA | 5.6 -1.5 | 6.8 -0.8 | 9.0 -0.4 | V |
| V _{ESD} | In-system ESD Withstand Voltage Contact Discharge per IEC 61000-4-2 Level 4 | (Notes 2, 3 and 4) | ±18 | | | kV |
| R _{DYN} | Dynamic Resistance Positive Negative | | | 2.3 0.9 | | Ω |
| f _R | Roll-off Frequency at -6 dB Attenuation Z _{SOURCE} = 50 Ω, Z _{LOAD} = 50 Ω | | | 300 | | MHz |

1. T_A = 25°C unless otherwise specified.
2. ESD applied to input and output pins with respect to GND, one at a time.
3. Clamping voltage is measured at the opposite side of the EMI filter to the ESD pin (i.e. if ESD is applied to pin A1 then clamping voltage is measured at pin C1). Unused pins are left open.
4. These parameters are guaranteed by design and characterization.

PERFORMANCE INFORMATION

Typical Filter Performance ($T_A = 25^\circ\text{C}$, DC Bias = 0 V, 50 Ohm Environment)

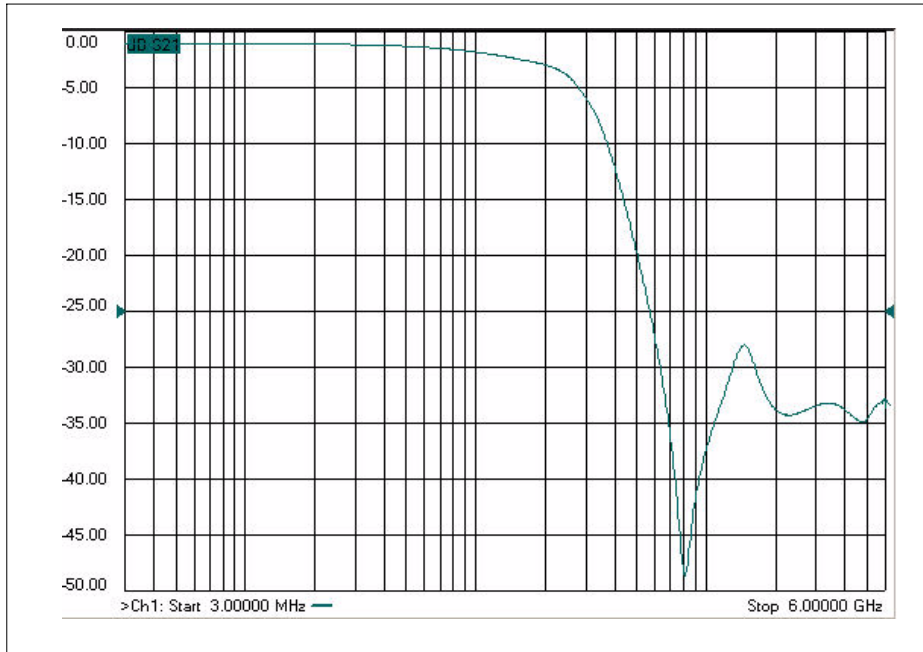

Figure 1. Typical Filter Insertion Loss (CM1693)

Typical Diode Capacitance vs. Input Voltage

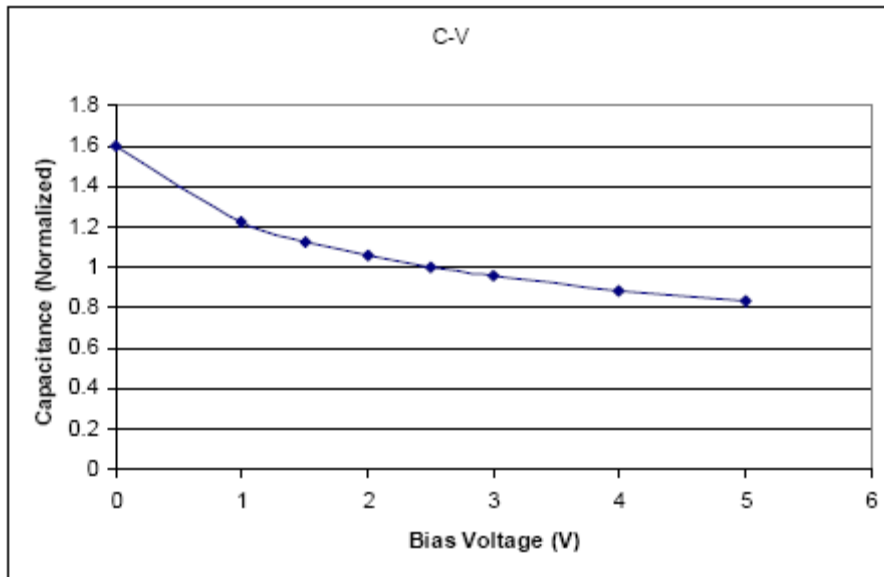

Figure 2. Filter Capacitance vs. Input Voltage (Normalized to Capacitance at 0 VDC and 25°C)

CM1693-04DE, CM1693-06DE, CM1693-08DE

MECHANICAL DETAILS

uDFN-08, uDFN-12 and uDFN-16 Mechanical Specifications, 0.4mm

The 8-lead, 12-lead and 16-lead, 0.4 mm pitch uDFN package dimensions are presented below.

Table 5. TAPE AND REEL SPECIFICATIONS

| Part Number | Package Size (mm) | Pocket Size (mm) $B_0 \times A_0 \times K_0$ | Tape Width [†] W | Reel Diameter | Qty per Reel | P_0 | P_1 |
|-------------|--------------------|---|------------------------------|---------------|--------------|-------|-------|
| CM1693-04DE | 1.70 x 1.35 x 0.50 | 1.95 x 1.60 x 0.60 | 8 mm | 178 mm (7") | 3000 | 4 mm | 4 mm |
| CM1693-06DE | 2.50 x 1.35 x 0.50 | 2.75 x 1.60 x 0.60 | 8 mm | 178 mm (7") | 3000 | 4 mm | 4 mm |
| CM1693-08DE | 3.30 x 1.35 x 0.50 | 3.50 x 1.55 x 0.70 | 12 mm | 178 mm (7") | 3000 | 4 mm | 4 mm |

[†]For information on tape and reel specifications, including part orientation and tape sizes, please refer to our Tape and Reel Packaging Specification Brochure, BRD8011/D.

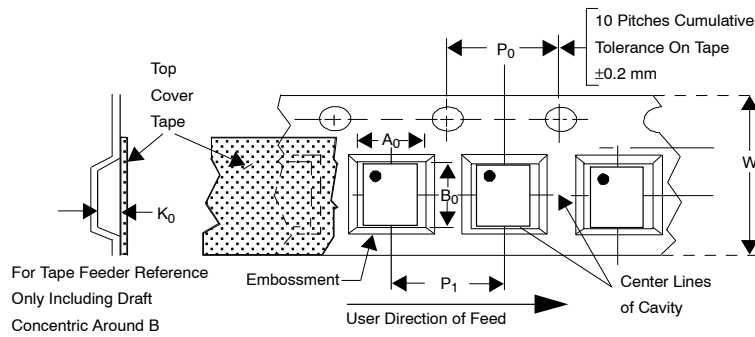

CM1693-04DE, CM1693-06DE, CM1693-08DE

PACKAGE DIMENSIONS

UDFN8, 1.7x1.35, 0.4P
CASE 517BC-01
ISSUE O

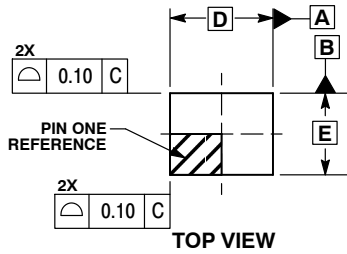

TOP VIEW

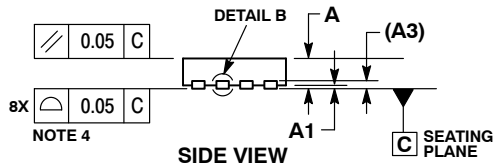

SIDE VIEW

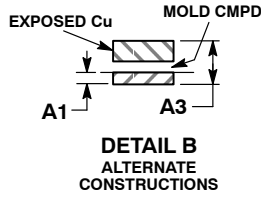

DETAIL B
ALTERNATE
CONSTRUCTIONS

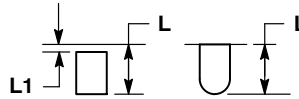

DETAIL A
ALTERNATE TERMINAL
CONSTRUCTIONS

NOTES:

1. DIMENSIONING AND TOLERANCING PER ASME Y14.5M, 1994.
2. CONTROLLING DIMENSION: MILLIMETERS.
3. DIMENSION b APPLIES TO PLATED TERMINAL AND IS MEASURED BETWEEN 0.15 AND 0.25 mm FROM THE TERMINAL TIP.
4. COPLANARITY APPLIES TO THE EXPOSED PAD AS WELL AS THE TERMINALS.

| MILLIMETERS | | |
|-------------|------|------|
| DIM | MIN | MAX |
| A | 0.45 | 0.55 |
| A1 | 0.00 | 0.05 |
| A3 | 0.13 | REF |
| b | 0.15 | 0.25 |
| D | 1.70 | BSC |
| D2 | 1.10 | 1.30 |
| E | 1.35 | BSC |
| E2 | 0.30 | 0.50 |
| e | 0.40 | BSC |
| K | 0.15 | --- |
| L | 0.20 | 0.30 |
| L1 | --- | 0.05 |

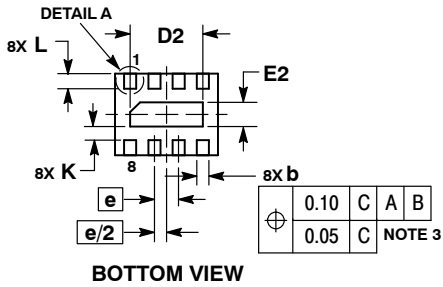

BOTTOM VIEW

RECOMMENDED SOLDERING FOOTPRINT*

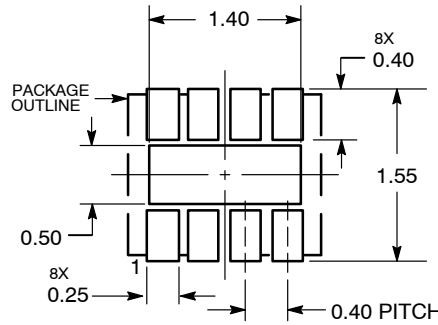

DIMENSIONS: MILLIMETERS

*For additional information on our Pb-Free strategy and soldering details, please download the ON Semiconductor Soldering and Mounting Techniques Reference Manual, SOLDERRM/D.

CM1693-04DE, CM1693-06DE, CM1693-08DE

PACKAGE DIMENSIONS

UDFN12, 2.5x1.35, 0.4P
CASE 517BD-01
ISSUE O

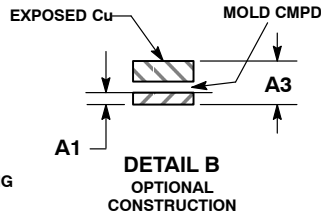
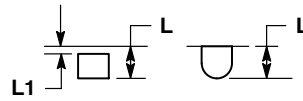
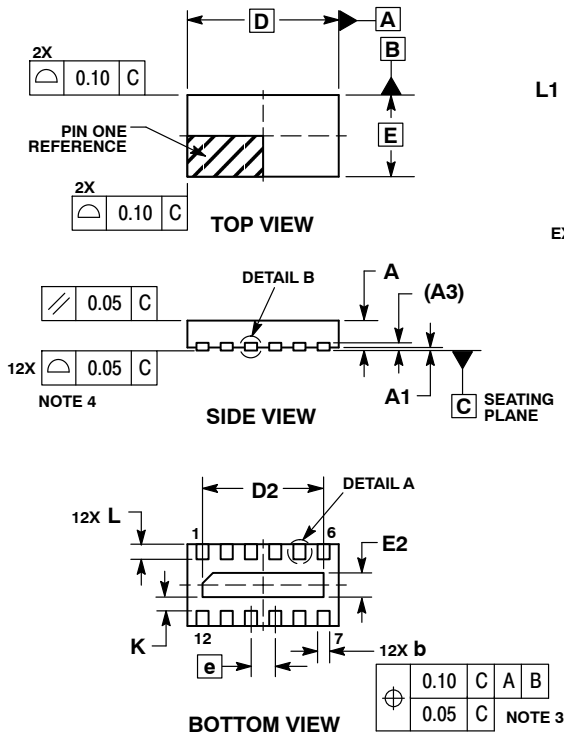

- NOTES:
1. DIMENSIONING AND TOLERANCING PER ASME Y14.5M, 1994.
 2. CONTROLLING DIMENSION: MILLIMETERS.
 3. DIMENSION b APPLIES TO PLATED TERMINAL AND IS MEASURED BETWEEN 0.15 AND 0.25 mm FROM THE TERMINAL TIP.
 4. COPLANARITY APPLIES TO THE EXPOSED PAD AS WELL AS THE TERMINALS.

| MILLIMETERS | | |
|-------------|------|------|
| DIM | MIN | MAX |
| A | 0.45 | 0.55 |
| A1 | 0.00 | 0.05 |
| A3 | 0.13 | REF |
| b | 0.15 | 0.25 |
| D | 2.50 | BSC |
| D2 | 1.90 | 2.10 |
| E | 1.35 | BSC |
| E2 | 0.30 | 0.50 |
| e | 0.40 | BSC |
| K | 0.15 | --- |
| L | 0.20 | 0.30 |
| L1 | --- | 0.05 |

RECOMMENDED SOLDERING FOOTPRINT*

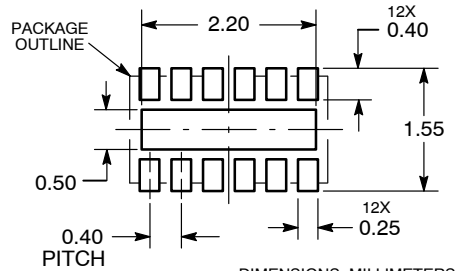

*For additional information on our Pb-Free strategy and soldering details, please download the ON Semiconductor Soldering and Mounting Techniques Reference Manual, SOLDERRM/D.

CM1693-04DE, CM1693-06DE, CM1693-08DE

PACKAGE DIMENSIONS

UDFN16, 3.3x1.35, 0.4P
CASE 517BE-01
ISSUE O

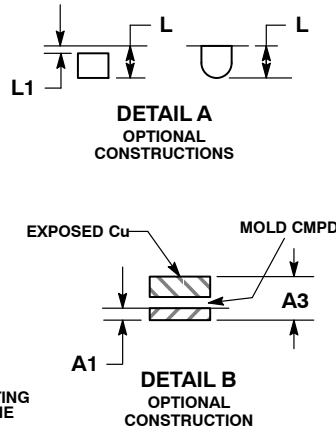
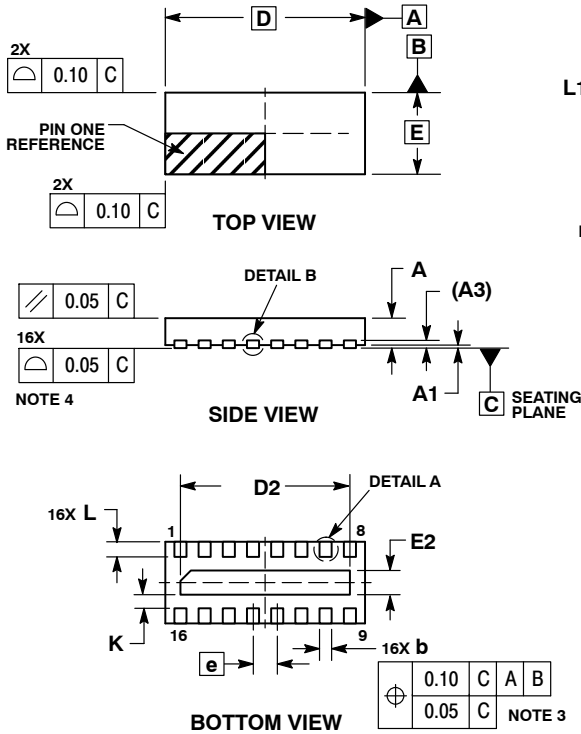

NOTES:

1. DIMENSIONING AND TOLERANCING PER ASME Y14.5M, 1994.
2. CONTROLLING DIMENSION: MILLIMETERS.
3. DIMENSION b APPLIES TO PLATED TERMINAL AND IS MEASURED BETWEEN 0.15 AND 0.25 mm FROM THE TERMINAL TIP.
4. COPLANARITY APPLIES TO THE EXPOSED PAD AS WELL AS THE TERMINALS.

| MILLIMETERS | | |
|-------------|------|------|
| DIM | MIN | MAX |
| A | 0.45 | 0.55 |
| A1 | 0.00 | 0.05 |
| A3 | 0.13 | REF |
| b | 0.15 | 0.25 |
| D | 3.30 | BSC |
| D2 | 2.70 | 2.90 |
| E | 1.35 | BSC |
| E2 | 0.30 | 0.50 |
| e | 0.40 | BSC |
| K | 0.15 | --- |
| L | 0.20 | 0.30 |
| L1 | --- | 0.05 |

RECOMMENDED SOLDERING FOOTPRINT*

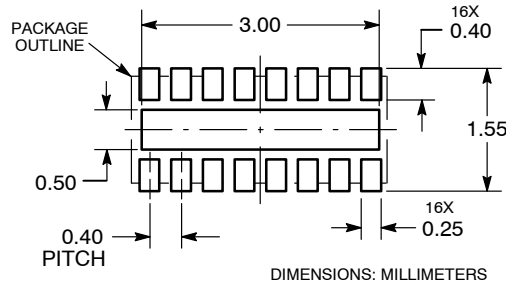

*For additional information on our Pb-Free strategy and soldering details, please download the ON Semiconductor Soldering and Mounting Techniques Reference Manual, SOLDERRM/D.

ON Semiconductor and are registered trademarks of Semiconductor Components Industries, LLC (SCILLC). SCILLC owns the rights to a number of patents, trademarks, copyrights, trade secrets, and other intellectual property. A listing of SCILLC's product/patent coverage may be accessed at www.onsemi.com/site/pdf/Patent-Marking.pdf. SCILLC reserves the right to make changes without further notice to any products herein. SCILLC makes no warranty, representation or guarantee regarding the suitability of its products for any particular purpose, nor does SCILLC assume any liability arising out of the application or use of any product or circuit, and specifically disclaims any and all liability, including without limitation special, consequential or incidental damages. "Typical" parameters which may be provided in SCILLC data sheets and/or specifications can and do vary in different applications and actual performance may vary over time. All operating parameters, including "Typicals" must be validated for each customer application by customer's technical experts. SCILLC does not convey any license under its patent rights nor the rights of others. SCILLC products are not designed, intended, or authorized for use as components in systems intended for surgical implant into the body, or other applications intended to support or sustain life, or for any other application in which the failure of the SCILLC product could create a situation where personal injury or death may occur. Should Buyer purchase or use SCILLC products for any such unintended or unauthorized application, Buyer shall indemnify and hold SCILLC and its officers, employees, subsidiaries, affiliates, and distributors harmless against all claims, costs, damages, and expenses, and reasonable attorney fees arising out of, directly or indirectly, any claim of personal injury or death associated with such unintended or unauthorized use, even if such claim alleges that SCILLC was negligent regarding the design or manufacture of the part. SCILLC is an Equal Opportunity/Affirmative Action Employer. This literature is subject to all applicable copyright laws and is not for resale in any manner.

PUBLICATION ORDERING INFORMATION

LITERATURE FULFILLMENT:
Literature Distribution Center for ON Semiconductor
P.O. Box 5163, Denver, Colorado 80217 USA
Phone: 303-675-2175 or 800-344-3860 Toll Free USA/Canada
Fax: 303-675-2176 or 800-344-3867 Toll Free USA/Canada
Email: orderlit@onsemi.com

N. American Technical Support: 800-282-9855 Toll Free
USA/Canada
Europe, Middle East and Africa Technical Support:
Phone: 421 33 790 2910
Japan Customer Focus Center
Phone: 81-3-5817-1050

ON Semiconductor Website: www.onsemi.com
Order Literature: <http://www.onsemi.com/orderlit>
For additional information, please contact your local Sales Representative

Данный компонент на территории Российской Федерации

Вы можете приобрести в компании MosChip.

Для оперативного оформления запроса Вам необходимо перейти по данной ссылке:

<http://moschip.ru/get-element>

Вы можете разместить у нас заказ для любого Вашего проекта, будь то серийное производство или разработка единичного прибора.

В нашем ассортименте представлены ведущие мировые производители активных и пассивных электронных компонентов.

Нашей специализацией является поставка электронной компонентной базы двойного назначения, продукции таких производителей как XILINX, Intel (ex.ALTERA), Vicor, Microchip, Texas Instruments, Analog Devices, Mini-Circuits, Amphenol, Glenair.

Сотрудничество с глобальными дистрибьюторами электронных компонентов, предоставляет возможность заказывать и получать с международных складов практически любой перечень компонентов в оптимальные для Вас сроки.

На всех этапах разработки и производства наши партнеры могут получить квалифицированную поддержку опытных инженеров.

Система менеджмента качества компании отвечает требованиям в соответствии с ГОСТ Р ИСО 9001, ГОСТ РВ 0015-002 и ЭС РД 009

Офис по работе с юридическими лицами:

105318, г.Москва, ул.Щербаковская д.3, офис 1107, 1118, ДЦ «Щербаковский»

Телефон: +7 495 668-12-70 (многоканальный)

Факс: +7 495 668-12-70 (доб.304)

E-mail: info@moschip.ru

Skype отдела продаж:

moschip.ru

moschip.ru_4

moschip.ru_6

moschip.ru_9