

# MAX14802/MAX14803/ MAX14803A

## Low-Charge Injection, 16-Channel, High-Voltage Analog Switches

### General Description

The MAX14802/MAX14803/MAX14803A provide high-voltage switching on 16 channels for ultrasonic imaging and printer applications. The devices utilize HVCMOS process technology to provide 16 high-voltage low-charge-injection SPST switches, controlled by a digital interface. Data is clocked into an internal 16-bit shift register and retained by a programmable latch with enable and clear inputs. A power-on reset function ensures that all switches are open on power-up.

The MAX14802/MAX14803/MAX14803A operate with a wide range of high-voltage supplies including  $V_{PP}/V_{NN} = +100V/-100V$ ,  $+200V/0V$ , or  $+40V/-160V$ . The digital interface operates from a separate  $+2.7V$  to  $+5.5V$   $V_{DD}$  supply. Digital inputs  $DIN$ ,  $CLK$ ,  $\overline{LE}$ , and  $CLR$  operate on the  $V_{DD}$  supply voltage.

The MAX14803/MAX14803A provide integrated  $35k\Omega$  bleed resistors on each switch terminal to discharge capacitive loads. The MAX14802/MAX14803/MAX14803A provide integrated clamping diodes for overvoltage protection against positive overshoot.

The MAX14802 is available in a 48-pin TQFP package and is specified for commercial  $0^{\circ}C$  to  $+70^{\circ}C$  and extended  $-40^{\circ}C$  to  $+85^{\circ}C$  temperature ranges.

The MAX14803 is available in a 48-pin TQFP package and is specified for the commercial  $0^{\circ}C$  to  $+70^{\circ}C$  temperature range.

The MAX14803A is available in the 110-bump wafer level package (WLP) and is specified at the  $-40^{\circ}C$  to  $+85^{\circ}C$  temperature range.

### Applications

Ultrasound Imaging  
Printers

### Features

- ◆ Integrated Overvoltage Protection
- ◆ 20MHz Serial Interface (5V)
- ◆ HVCMOS Technology for High Performance
- ◆ Individually Programmable High-Voltage Analog Switches
- ◆ Very Low  $5\mu A$  (typ) Quiescent Current
- ◆ DC-to-20MHz Low-Voltage Analog Signal Frequency Range
- ◆ 2.7V to 5.5V Logic Supply Voltage
- ◆ Low-Charge Injection, Low-Capacitance  $R_L$  Switches
- ◆ -77dB (typ) Off-Isolation at 5MHz ( $R_L = 50\Omega$ )
- ◆ Daisy-Chainable Serial Interface
- ◆ Flexible High-Voltage Supplies ( $V_{PP} - V_{NN} = 250V$ )

*Pin Configurations appear at end of data sheet.*

### Ordering Information/Selector Guide

PART	SWITCH CHANNELS	BLEED RESISTOR	OVP	PIN-PACKAGE	TEMP RANGE
MAX14802CCM+	16	No	Yes	48 TQFP	$0^{\circ}C$ to $+70^{\circ}C$
MAX14802ECM+	16	No	Yes	48 TQFP	$-40^{\circ}C$ to $+85^{\circ}C$
MAX14803CCM+	16	Yes	Yes	48 TQFP	$0^{\circ}C$ to $+70^{\circ}C$
MAX14803AEWZ+	16	Yes	Yes	110 WLP	$-40^{\circ}C$ to $+85^{\circ}C$

+Denotes a lead(Pb)-free/RoHS-compliant package.

**For pricing, delivery, and ordering information, please contact Maxim Direct at 1-888-629-4642, or visit Maxim's website at [www.maximintegrated.com](http://www.maximintegrated.com).**

# MAX14802/MAX14803/MAX14803A

## Low-Charge Injection, 16-Channel, High-Voltage Analog Switches

### ABSOLUTE MAXIMUM RATINGS

(All voltages referenced to GND.)

V <sub>DD</sub> Logic-Supply Voltage	.....-0.3V to +7V
V <sub>PP</sub> - V <sub>NN</sub> Supply Voltage (MAX14802CCM+, MAX14803CCM+)	.....260V
(MAX14802ECM+, MAX14803AEWZ+)	.....230V
V <sub>PP</sub> Positive-Supply Voltage	.....-0.3V to +220V
V <sub>NN</sub> Negative-Supply Voltage	.....-0.3V to -220V
Logic Inputs ( $\overline{LE}$ , CLR, CLK, DIN, DOUT)	.....-0.3V to +7V
COM <sub>-</sub> , NO <sub>-</sub>	.....(-0.3V + V <sub>NN</sub> ) to the minimum of [(V <sub>NN</sub> + 220V) or (V <sub>PP</sub> + 0.3V)]

Peak Analog Signal Current Per Channel	.....3A
Continuous Power Dissipation (T <sub>A</sub> = +70°C)	
48-Pin TQFP (derate 22.7mW/°C above +70°C)	.....1818mW
110-Bump WLP (derate 37mW/°C above +70°C)	.....2960mW
Operating Temperature Range (Commercial)	.....0°C to +70°C
Operating Temperature Range (Extended)	.....-40°C to +85°C
Storage Temperature Range	.....-65°C to +150°C
Junction Temperature	.....+150°C
Lead Temperature (soldering, 10s)	.....+300°C
Soldering Temperature (reflow)	.....+260°C

### PACKAGE THERMAL CHARACTERISTICS (Note 1)

TQFP		WLP	
Junction-to-Ambient Thermal Resistance (θ <sub>JA</sub> )	.....44°C/W	Junction-to-Ambient Thermal Resistance (θ <sub>JA</sub> )	.....27°C/W
Junction-to-Case Thermal Resistance (θ <sub>JC</sub> )	.....10°C/W	Junction-to-Case Thermal Resistance (θ <sub>JC</sub> )	.....1°C/W

**Note 1:** Package thermal resistances were obtained using the method described in JEDEC specification JESD51-7, using a four-layer board. For detailed information on package thermal considerations, refer to [www.maximintegrated.com/thermal-tutorial](http://www.maximintegrated.com/thermal-tutorial).

Stresses beyond those listed under "Absolute Maximum Ratings" may cause permanent damage to the device. These are stress ratings only, and functional operation of the device at these or any other conditions beyond those indicated in the operational sections of the specifications is not implied. Exposure to absolute maximum rating conditions for extended periods may affect device reliability.

### ELECTRICAL CHARACTERISTICS

(V<sub>DD</sub> = +2.7V to +5.5V, V<sub>PP</sub> = +40V to V<sub>NN</sub> + 250V, V<sub>NN</sub> = -40V to -160V, T<sub>A</sub> = T<sub>MIN</sub> to T<sub>MAX</sub>, unless otherwise noted. Typical values are at T<sub>A</sub> = +25°C.) (Note 2)

PARAMETER	SYMBOL	CONDITIONS	MIN	TYP	MAX	UNITS
<b>POWER SUPPLIES</b>						
V <sub>DD</sub> Supply Voltage	V <sub>DD</sub>		+2.7		+5.5	V
V <sub>PP</sub> Supply Voltage	V <sub>PP</sub>	MAX14802ECM+, MAX14803AEWZ+	+40	+100	V <sub>NN</sub> + 200	V
		MAX14802CCM+, MAX14803CCM+	+40	+100	V <sub>NN</sub> + 250	
V <sub>NN</sub> Supply Voltage	V <sub>NN</sub>		-160	-100	0	V
V <sub>DD</sub> Supply Quiescent Current	I <sub>DDQ</sub>				5	μA
V <sub>DD</sub> Supply Dynamic Current	I <sub>DD</sub>	V <sub>DD</sub> = +5V, V $\overline{LE}$ = +5V, f <sub>CLK</sub> = 5MHz			0.5	mA
V <sub>PP</sub> Supply Quiescent Current	I <sub>PPQ</sub>	All switches remain on or off, I <sub>COM-</sub> = 5mA		0	10	μA

# MAX14802/MAX14803/MAX14803A

## Low-Charge Injection, 16-Channel, High-Voltage Analog Switches

### ELECTRICAL CHARACTERISTICS (continued)

( $V_{DD} = +2.7V$  to  $+5.5V$ ,  $V_{PP} = +40V$  to  $V_{NN} + 250V$ ,  $V_{NN} = -40V$  to  $-160V$ ,  $T_A = T_{MIN}$  to  $T_{MAX}$ , unless otherwise noted. Typical values are at  $T_A = +25^\circ C$ .) (Note 2)

PARAMETER	SYMBOL	CONDITIONS	MIN	TYP	MAX	UNITS
V <sub>PP</sub> Supply Dynamic Current (All Channel Switching Simultaneously)	I <sub>PP</sub>	V <sub>PP</sub> = +40V, V <sub>NN</sub> = -160V, f <sub>COM_</sub> = 50kHz			4	mA
		V <sub>PP</sub> = +100V, V <sub>NN</sub> = -100V, f <sub>COM_</sub> = 50kHz		3.4	6	
		V <sub>PP</sub> = +160V, V <sub>NN</sub> = -40V, f <sub>COM_</sub> = 50kHz			8	
V <sub>NN</sub> Supply Quiescent Current	I <sub>NNQ</sub>	All switches remain on or off, I <sub>COM_</sub> = 5mA		0	10	μA
V <sub>NN</sub> Supply Dynamic Current (All Channel Switching Simultaneously)	I <sub>NN</sub>	V <sub>PP</sub> = +40V, V <sub>NN</sub> = -160V, f <sub>COM_</sub> = 50kHz			5	mA
		V <sub>PP</sub> = +100V, V <sub>NN</sub> = -100V, f <sub>COM_</sub> = 50kHz		2.3	4	
		V <sub>PP</sub> = +160V, V <sub>NN</sub> = -40V, f <sub>COM_</sub> = 50kHz			3	
<b>ANALOG SWITCH</b>						
COM_, NO_ Analog Signal Range	V <sub>COM_</sub> , V <sub>NO_</sub>	(Note 3)	V <sub>NN</sub>		min of (V <sub>NN</sub> + 200V) or (V <sub>PP</sub> - 10V)	V
Small-Signal Switch On-Resistance	R <sub>ONS</sub>	V <sub>PP</sub> = +40V, V <sub>NN</sub> = -160V, V <sub>COM_</sub> = 0V	I <sub>COM_</sub> = 5mA	26	48	Ω
			I <sub>COM_</sub> = 200mA	22	32	
		V <sub>PP</sub> = +100V, V <sub>NN</sub> = -100V, V <sub>COM_</sub> = 0V	I <sub>COM_</sub> = 5mA	22	30	
			I <sub>COM_</sub> = 200mA	18	27	
		V <sub>PP</sub> = +160V, V <sub>NN</sub> = -40V, V <sub>COM_</sub> = 0V	I <sub>COM_</sub> = 5mA	20	30	
			I <sub>COM_</sub> = 200mA	16	27	
Small-Signal Switch On-Resistance Matching	ΔR <sub>ONS</sub>	V <sub>PP</sub> = +100V, V <sub>NN</sub> = -100V, V <sub>COM_</sub> = 0V, I <sub>COM_</sub> = 5mA		5		%
Large-Signal Switch On-Resistance	R <sub>ONL</sub>	V <sub>COM_</sub> = V <sub>PP</sub> - 10V, I <sub>COM_</sub> = 1A		15		Ω
Shunt Resistance	R <sub>INT</sub>	NO_ or COM_ to GND (MAX14803/MAX14803A), switch off	30	40	50	KΩ
Switch-Off Leakage	I <sub>COM_(OFF)</sub> , I <sub>NO_(OFF)</sub>	V <sub>COM_</sub> , V <sub>NO_</sub> = +100V or unconnected		0	2	μA
Switch-Off DC Offset		R <sub>L</sub> = 100kΩ	-30		+30	mV
Switch-Output Peak Current		100ns pulse width, 0.1% duty cycle (Note 4)		3		A
Switch-Output COM_ Isolation Diode Current		300ns pulse width, 2% duty cycle (Note 4)		500		mA

# MAX14802/MAX14803/MAX14803A

## Low-Charge Injection, 16-Channel, High-Voltage Analog Switches

### ELECTRICAL CHARACTERISTICS (continued)

( $V_{DD} = +2.7V$  to  $+5.5V$ ,  $V_{PP} = +40V$  to  $V_{NN} + 250V$ ,  $V_{NN} = -40V$  to  $-160V$ ,  $T_A = T_{MIN}$  to  $T_{MAX}$ , unless otherwise noted. Typical values are at  $T_A = +25^\circ C$ .) (Note 2)

PARAMETER	SYMBOL	CONDITIONS	MIN	TYP	MAX	UNITS
<b>SWITCH DYNAMIC CHARACTERISTICS</b>						
Turn-On Time	$t_{ON}$	$V_{NO\_} = +100V$ , $R_L = 10k\Omega$ , $V_{NN} = -100V$		2	3.5	$\mu s$
Turn-Off Time	$t_{OFF}$	$V_{NO\_} = +100V$ , $R_L = 10k\Omega$ , $V_{NN} = -100V$		2	3.5	$\mu s$
Output Switching Frequency	$f_{SW}$	Duty cycle = 50%			50	kHz
Maximum $V_{COM\_}$ , $V_{NO\_}$ Slew Rate	dV/dt	(Note 4)	20			V/ns
Off-Isolation	$V_{ISO}$	$f = 5MHz$ , $R_L = 1k\Omega$ , $C_L = 15pF$		-50		dB
		$f = 5MHz$ , $R_L = 50\Omega$		-77		
Crosstalk	$V_{CT}$	$f = 5MHz$ , $R_L = 50\Omega$		-80		dB
$COM\_$ , $NO\_$ Off-Capacitance	$C_{COM\_}(OFF)$ , $C_{NO\_}(OFF)$	$V_{COM\_} = 0V$ , $V_{NO\_} = 0V$ , $f = 1MHz$ (Note 4)	4	11	18	pF
$COM\_$ On-Capacitance	$C_{COM\_}(ON)$	$V_{COM\_} = 0V$ , $f = 1MHz$ (Note 4)	20	36	56	pF
Output-Voltage Spike	$V_{SPK}$	$R_L = 50\Omega$ (Note 4)	-150		+150	mV
Small-Signal Analog Bandwidth	$f_{BW}$	$V_{PP} = +100V$ , $V_{NN} = -100V$ , $C_L = 200pF$		20		MHz
Charge Injection	Q	$V_{PP} = +40V$ , $V_{NN} = -160V$ , $V_{COM\_} = 0V$		820		pC
		$V_{PP} = +100V$ , $V_{NN} = -100V$ , $V_{COM\_} = 0V$		600		
		$V_{PP} = +160V$ , $V_{NN} = -40V$ , $V_{COM\_} = 0V$		350		
<b>LOGIC LEVELS</b>						
Logic-Input Low Voltage	$V_{IL}$				0.75	V
Logic-Input High Voltage	$V_{IH}$		$V_{DD} - 0.75$			V
Logic-Output Low Voltage	$V_{OL}$	$I_{SINK} = 1mA$			0.4	V
Logic-Output High Voltage	$V_{OH}$	$I_{SOURCE} = 0.75mA$	$V_{DD} - 0.5$			V
Logic-Input Capacitance	$C_{IN}$	(Note 4)			10	pF
Logic-Input Leakage	$I_{IN}$		-1		+1	$\mu A$

# MAX14802/MAX14803/MAX14803A

## Low-Charge Injection, 16-Channel, High-Voltage Analog Switches

### TIMING CHARACTERISTICS

( $V_{DD} = +2.7V$  to  $+5.5V$ ,  $V_{PP} = +40V$  to  $V_{NN} + 200V$ ,  $V_{NN} = -40V$  to  $-160V$ ,  $T_A = T_{MIN}$  to  $T_{MAX}$ , unless otherwise noted. Typical values are at  $T_A = +25^\circ C$ .) (Note 2)

PARAMETER	SYMBOL	CONDITIONS	MIN	TYP	MAX	UNITS
<b>LOGIC TIMING (Figure 1)</b>						
CLK Frequency	$f_{CLK}$	$V_{DD} = +5V \pm 10\%$			20	MHz
		$V_{DD} = +3V \pm 10\%$			10	
DIN to CLK Setup Time	$t_{DS}$	$V_{DD} = +5V \pm 10\%$	10			ns
		$V_{DD} = +3V \pm 10\%$	16			
DIN to CLK Hold Time	$t_{DH}$	$V_{DD} = +5V \pm 10\%$	3			ns
		$V_{DD} = +3V \pm 10\%$	3			
CLK to $\overline{LE}$ Setup Time	$t_{CS}$	$V_{DD} = +5V \pm 10\%$	36			ns
		$V_{DD} = +3V \pm 10\%$	65			
$\overline{LE}$ Low-Pulse Width	$t_{WL}$	$V_{DD} = +5V \pm 10\%$	14			ns
		$V_{DD} = +3V \pm 10\%$	22			
CLR High-Pulse Width	$t_{WC}$	$V_{DD} = +5V \pm 10\%$	20			ns
		$V_{DD} = +3V \pm 10\%$	40			
CLK Rise and Fall Times	$t_R, t_F$	$V_{DD} = +5V \pm 10\%$			50	ns
		$V_{DD} = +3V \pm 10\%$			50	
CLK to DOUT Delay	$t_{DO}$	$V_{DD} = +5V \pm 10\%$	6		42	ns
		$V_{DD} = +3V \pm 10\%$	12		80	

**Note 2:** All devices are 100% tested at  $T_A = +70^\circ C$ . Limits over the operating temperature range are guaranteed by design and characterization.

**Note 3:** The analog signal input  $V_{COM\_}$  and  $V_{NO\_}$  must satisfy  $V_{NN} \leq (V_{COM\_}, V_{NO\_}) \leq V_{PP}$ , or remain unconnected during power-up and power-down.

**Note 4:** Guaranteed by characterization; not production tested.

# MAX14802/MAX14803/MAX14803A

## Low-Charge Injection, 16-Channel, High-Voltage Analog Switches

### Test Circuits



# MAX14802/MAX14803/MAX14803A

## Low-Charge Injection, 16-Channel, High-Voltage Analog Switches

### Typical Operating Characteristics

( $V_{DD} = +3V$ ,  $V_{PP} = +100V$ ,  $V_{NN} = -100V$ ,  $T_A = +25^\circ C$ , unless otherwise noted.)

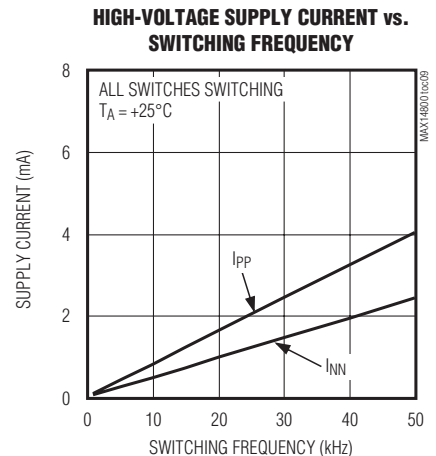
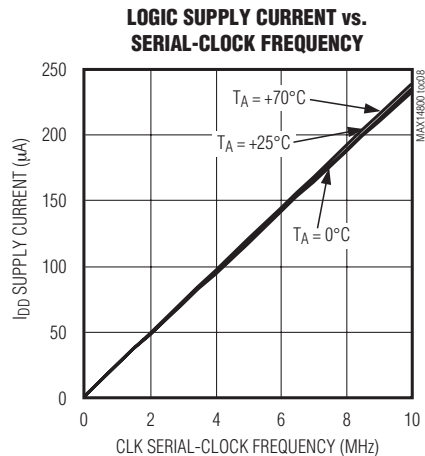
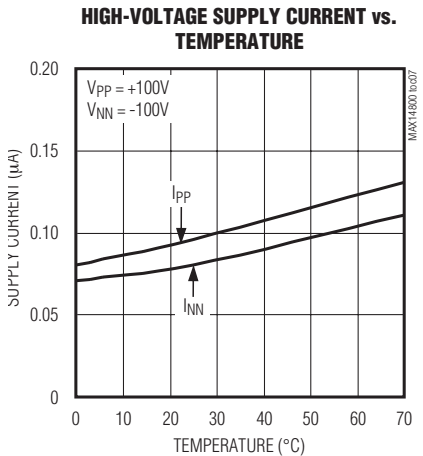
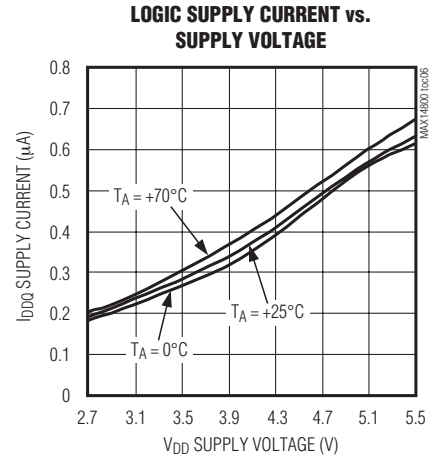
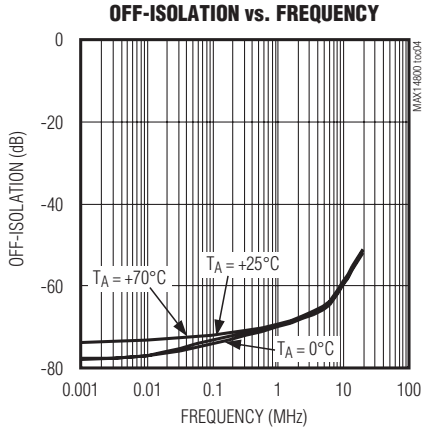
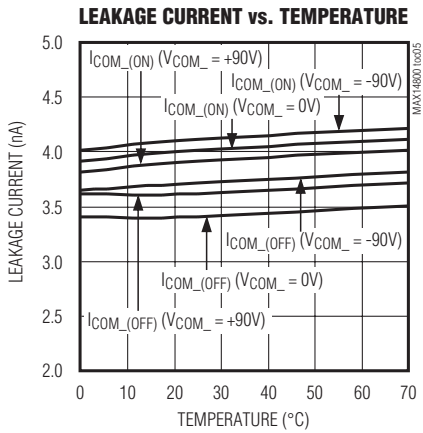
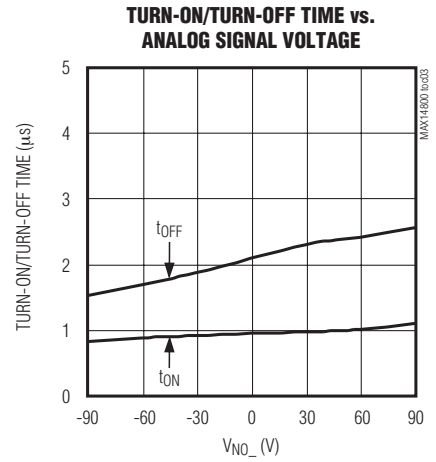
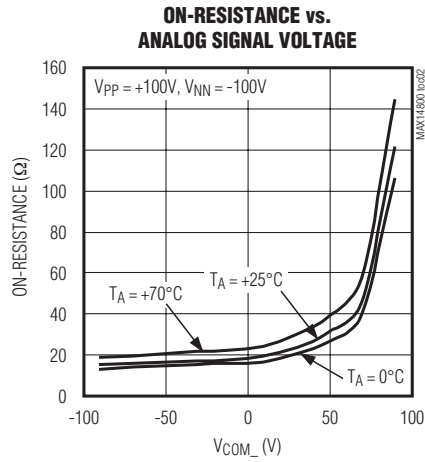
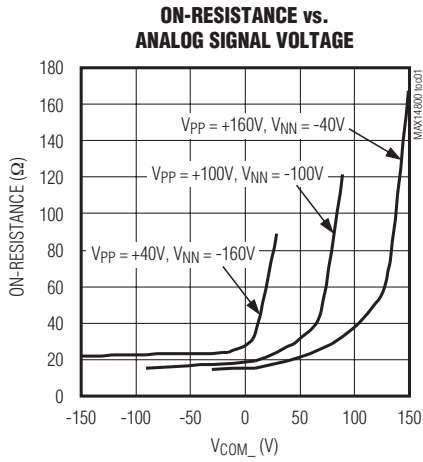

# MAX14802/MAX14803/MAX14803A

## Low-Charge Injection, 16-Channel, High-Voltage Analog Switches

### Pin Description

PIN		NAME	FUNCTION
TQFP	WLP		
1, 2, 14, 16, 24, 35, 36	A1, A3, A5, A8, A9, A11, B1–B5, B10, B11, C1, C3, C5, C6, C7, C9, C11, D2, D4–D8, D10, E1, E3–E9, E11, F2, F4–F8, F10, G1, G3, G5, G6, G7, G9, G11, H2, H4, H6, H8, H10, J1, J3, J5, J6, J7, J9, J11, K1, K2, K4, K6, K8, K10, K11	N.C.	No Connection. Not internally connected.
3	J2	COM4	Analog Switch 4—Common Terminal
4	H1	NO4	Analog Switch 4—Normally-Open Terminal
5	F3	NO3	Analog Switch 3—Normally-Open Terminal
6	F1	COM3	Analog Switch 3—Common Terminal
7	G2	NO2	Analog Switch 2—Normally-Open Terminal
8	E2	COM2	Analog Switch 2—Common Terminal
9	D3	COM1	Analog Switch 1—Common Terminal
10	D1	NO1	Analog Switch 1—Normally-Open Terminal
11	C2	NO0	Analog Switch 0—Normally-Open Terminal
12	C4	COM0	Analog Switch 0—Common Terminal
13	A4	V <sub>NN</sub>	Negative High-Voltage Supply. Bypass V <sub>NN</sub> to GND with a 0.1µF or greater ceramic capacitor.
15	A2	V <sub>PP</sub>	Positive High-Voltage Supply. Bypass V <sub>PP</sub> to GND with a 0.1µF or greater ceramic capacitor.
17	B6	GND	Ground
18	A10	V <sub>DD</sub>	Digital Supply Voltage. Bypass V <sub>DD</sub> to GND with a 0.1µF or greater ceramic capacitor.
19	B7	DIN	Serial-Data Input
20	A6	CLK	Serial-Clock Input
21	B8	$\overline{LE}$	Active-Low, Latch-Enable Input
22	B9	CLR	Latch Clear Input
23	A7	DOUT	Serial-Data Output
25	C8	COM15	Analog Switch 15—Common Terminal
26	C10	NO15	Analog Switch 15—Normally-Open Terminal
27	D11	NO14	Analog Switch 14—Normally-Open Terminal
28	D9	COM14	Analog Switch 14—Common Terminal
29	E10	COM13	Analog Switch 13—Common Terminal
30	G10	NO13	Analog Switch 13—Normally-Open Terminal
31	F11	COM12	Analog Switch 12—Common Terminal



# MAX14802/MAX14803/MAX14803A

## Low-Charge Injection, 16-Channel, High-Voltage Analog Switches

### Pin Description (continued)

PIN		NAME	FUNCTION
TQFP	WLP		
32	F9	NO12	Analog Switch 12—Normally-Open Terminal
33	H11	NO11	Analog Switch 11—Normally-Open Terminal
34	J10	COM11	Analog Switch 11—Common Terminal
37	H9	COM10	Analog Switch 10—Common Terminal
38	K9	NO10	Analog Switch 10—Normally-Open Terminal
39	J8	COM9	Analog Switch 9—Common Terminal
40	G8	NO9	Analog Switch 9—Normally-Open Terminal
41	H7	COM8	Analog Switch 8—Common Terminal
42	K7	NO8	Analog Switch 8—Normally-Open Terminal
43	K5	NO7	Analog Switch 7—Normally-Open Terminal
44	H5	COM7	Analog Switch 7—Common Terminal
45	G4	NO6	Analog Switch 6—Normally-Open Terminal
46	J4	COM6	Analog Switch 6—Common Terminal
47	K3	NO5	Analog Switch 5—Normally-Open Terminal
48	H3	COM5	Analog Switch 5—Common Terminal



Figure 1. Serial Interface Timing

# MAX14802/MAX14803/MAX14803A

## Low-Charge Injection, 16-Channel, High-Voltage Analog Switches

### Detailed Description

The MAX14802/MAX14803/MAX14803A provide high-voltage switching on 16 channels for ultrasound imaging and printer applications. The devices utilize HVCMOS process technology to provide 16 high-voltage low-charge-injection SPST switches, controlled by a digital interface. Data is clocked into an internal 16-bit shift register and retained by a programmable latch with enable and clear inputs. A power-on-reset function ensures that all switches are open on power-up.

The MAX14802/MAX14803/MAX14803A operate with a wide range of high-voltage supplies including:  $V_{PP}/V_{NN} = +100V/-100V$ ,  $+200V/0V$ , or  $+40V/-160V$ . The digital interface operates from a separate  $+2.7V$  to  $+5.5V$   $V_{DD}$  supply. Digital inputs DIN, CLK,  $\overline{LE}$ , and CLR operate on the  $V_{DD}$  supply voltage. The MAX14803/MAX14803A provide integrated  $35k\Omega$  bleed resistors on each switch terminal to discharge capacitive loads. The MAX14802/MAX14803/MAX14803A feature clamping diodes (at the COM<sub>1</sub>). These clamping diodes provide overvoltage protection against positive overshoot.

### Analog Switch

The MAX14802/MAX14803/MAX14803A allow a peak-to-peak analog signal range from  $V_{NN}$  to the minimum of either  $V_{NN} + 200V$  or  $(V_{PP} - 10V)$ . Analog switch inputs must be unconnected, or satisfy  $V_{NN} \leq (V_{COM1}, V_{NO1}) \leq V_{PP}$  during power-up and power-down.

### High-Voltage Supplies

The MAX14802/MAX14803/MAX14803A allow a wide range of high-voltage supplies. The devices operate with  $V_{NN}$  from  $-160V$  to  $0$  and  $V_{PP}$  from  $+40V$  to  $V_{NN} + 250V$ . When  $V_{NN}$  is connected to GND (single-supply applications), the devices operate with  $V_{PP}$  up to  $+200V$ . The  $V_{PP}$  and  $V_{NN}$  high-voltage supplies are not required to be symmetrical, but the voltage difference ( $V_{PP} - V_{NN}$ ) must not exceed  $250V$ .

### Bleed Resistors (MAX14803/MAX14803A)

The MAX14803/MAX14803A feature integrated  $35k\Omega$  bleed resistors to discharge capacitive loads such as piezoelectric transducers. Each analog switch terminal is connected to GND with a bleed resistor.

### Overvoltage Protection

The MAX14802/MAX14803/MAX14803A feature clamping diodes (at the COM<sub>1</sub>). These clamping diodes provide overvoltage protection against positive overshoot.

### Serial Interface

The MAX14802/MAX14803/MAX14803A are controlled by a serial interface with a 16-bit serial shift register and transparent latch. Each of the 16 data bits controls a single analog switch (Table 1). Data on DIN is clocked with the most significant bit (MSB) first into the shift register on the rising edge of CLK. Data is clocked out of the shift register onto DOUT on the rising edge of CLK. DOUT reflects the status of DIN, delayed by 16 clock cycles (Figures 1 and 2).

### Latch Enable ( $\overline{LE}$ )

Drive  $\overline{LE}$  logic-low to change the contents of the latch and update the state of the high-voltage switches (Figure 2). Drive  $\overline{LE}$  logic-high to freeze the contents of the latch and prevent changes to the switch states. To reduce noise due to clock feedthrough, drive  $\overline{LE}$  logic-high while data is clocked into the shift register. After the data shift register is loaded with valid data, pulse  $\overline{LE}$  logic-low to load the contents of the shift register into the latch.

### Latch Clear (CLR)

The MAX14802/MAX14803/MAX14803A feature a latch clear input. Drive CLR logic-high to reset the contents of the latch to zero and open all switches. CLR does not affect the contents of the data shift register. Pulse  $\overline{LE}$  logic-low to reload the contents of the shift register into the latch.

### Power-On Reset

The MAX14802/MAX14803/MAX14803A feature a power-on-reset circuit to ensure all switches are open at power-on. The internal 16-bit serial shift register and latch are set to zero on power-up.

# MAX14802/MAX14803/MAX14803A

## Low-Charge Injection, 16-Channel, High-Voltage Analog Switches

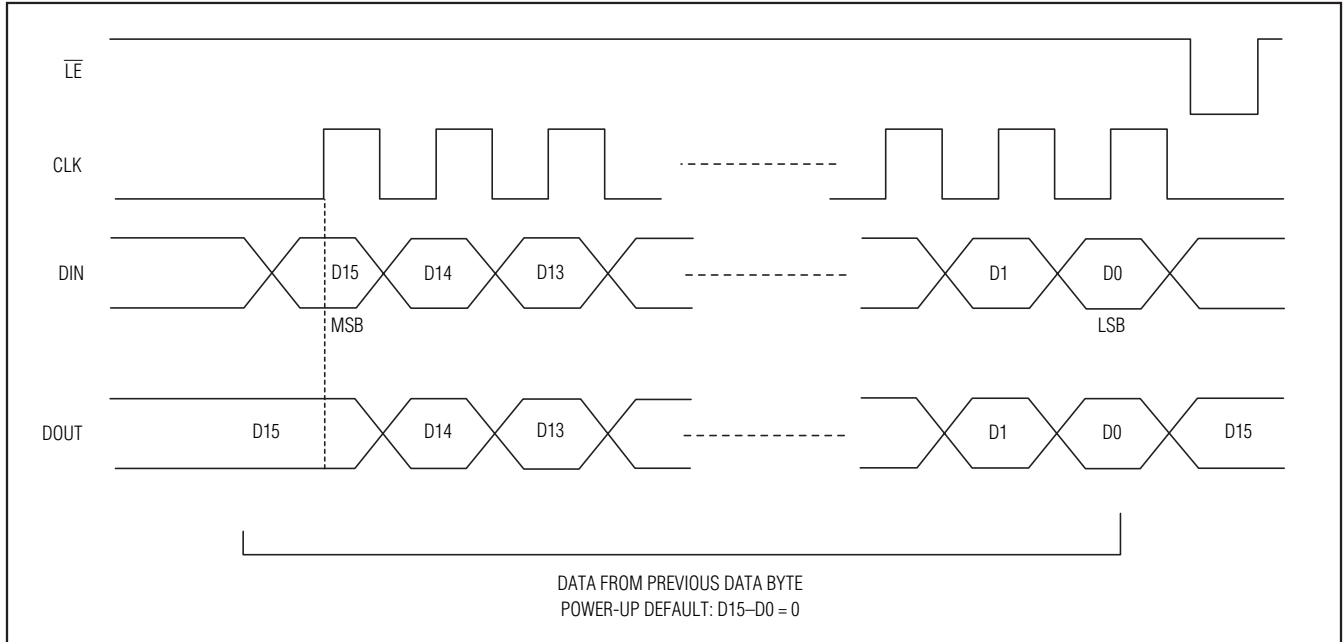

Figure 2. Latch Enable Interface Timing

Table 1. Serial Interface Programming (Notes 5–10)

DATA BITS								CONTROL BITS		FUNCTION							
D0 (LSB)	D1	D2	D3	D4	D5	D6	D7	$\overline{\text{LE}}$	CLR	SW0	SW1	SW2	SW3	SW4	SW5	SW6	SW7
L								L	L	OFF							
H								L	L	ON							
	L							L	L		OFF						
	H							L	L		ON						
		L						L	L			OFF					
		H						L	L			ON					
			L					L	L				OFF				
			H					L	L				ON				
				L				L	L					OFF			
				H				L	L					ON			
					L			L	L						OFF		
					H			L	L						ON		
						L		L	L								OFF
						H		L	L								ON
X	X	X	X	X	X	X	X	H	L	HOLD PREVIOUS STATE							
X	X	X	X	X	X	X	X	X	H	OFF	OFF	OFF	OFF	OFF	OFF	OFF	OFF

# MAX14802/MAX14803/MAX14803A

## Low-Charge Injection, 16-Channel, High-Voltage Analog Switches

Table 1. Serial Interface Programming (Notes 5–10) (continued)

DATA BITS								CONTROL BITS		FUNCTION								
D8	D9	D10	D11	D12	D13	D14	D15 (MSB)	$\overline{\text{LE}}$	CLR	SW8	SW9	SW10	SW11	SW12	SW13	SW14	SW15	
L								L	L	OFF								
H								L	L	ON								
	L							L	L		OFF							
	H							L	L		ON							
		L						L	L			OFF						
		H						L	L			ON						
			L					L	L				OFF					
			H					L	L				ON					
				L				L	L					OFF				
				H				L	L					ON				
					L			L	L						OFF			
					H			L	L						ON			
						L		L	L								OFF	
						H		L	L								ON	
							L	L	L									OFF
							H	L	L									ON
X	X	X	X	X	X	X	X	H	L	HOLD PREVIOUS STATE								
X	X	X	X	X	X	X	X	X	H	OFF	OFF	OFF	OFF	OFF	OFF	OFF	OFF	OFF

X = Don't care.

**Note 5:** The 16 switches operate independently.

**Note 6:** Serial data is clocked in on the rising edge of CLK.

**Note 7:** The switches go to a state retaining their present condition on the rising edge of  $\overline{\text{LE}}$ . When  $\overline{\text{LE}}$  is low, the shift register data flows through the latch.

**Note 8:** DOUT is high when switch 15 is on.

**Note 9:** Shift register clocking has no effect on the switch states if  $\overline{\text{LE}}$  is high.

**Note 10:** The CLR input overrides all other inputs.

# MAX14802/MAX14803/MAX14803A

## Low-Charge Injection, 16-Channel, High-Voltage Analog Switches

### Applications Information

For medical ultrasound applications, see Figures 4, 5, and 6.

### Logic Levels

The MAX14802/MAX14803/MAX14803A digital interface inputs CLK, DIN,  $\overline{\text{LE}}$ , and CLR operate on the  $V_{\text{DD}}$  supply voltage.

### Daisy-Chaining Multiple Devices

Digital output DOUT is provided to allow the connection of multiple MAX14802/MAX14803/MAX14803A devices by daisy-chaining (Figure 3). Connect each DOUT to the DIN of the subsequent device in the chain. Connect CLK,  $\overline{\text{LE}}$ , and CLR inputs of all devices, and drive  $\overline{\text{LE}}$  logic-low to update all devices simultaneously. Drive CLR high to open all the switches simultaneously. Additional shift registers can be included anywhere in series with the MAX14802/MAX14803/MAX14803A data chain.

### Supply Sequencing and Bypassing

The MAX14802/MAX14803/MAX14803A do not require special sequencing of the  $V_{\text{DD}}$ ,  $V_{\text{PP}}$ , and  $V_{\text{NN}}$  supply voltages; however, analog switch inputs must be unconnected, or satisfy  $V_{\text{NN}} \leq (V_{\text{COM}_-}, V_{\text{NO}_-}) \leq V_{\text{PP}}$  during power-up and power-down. Bypass  $V_{\text{DD}}$ ,  $V_{\text{PP}}$ , and  $V_{\text{NN}}$  to GND with a 0.1 $\mu\text{F}$  ceramic capacitor as close as possible to the device.

### Application Diagrams

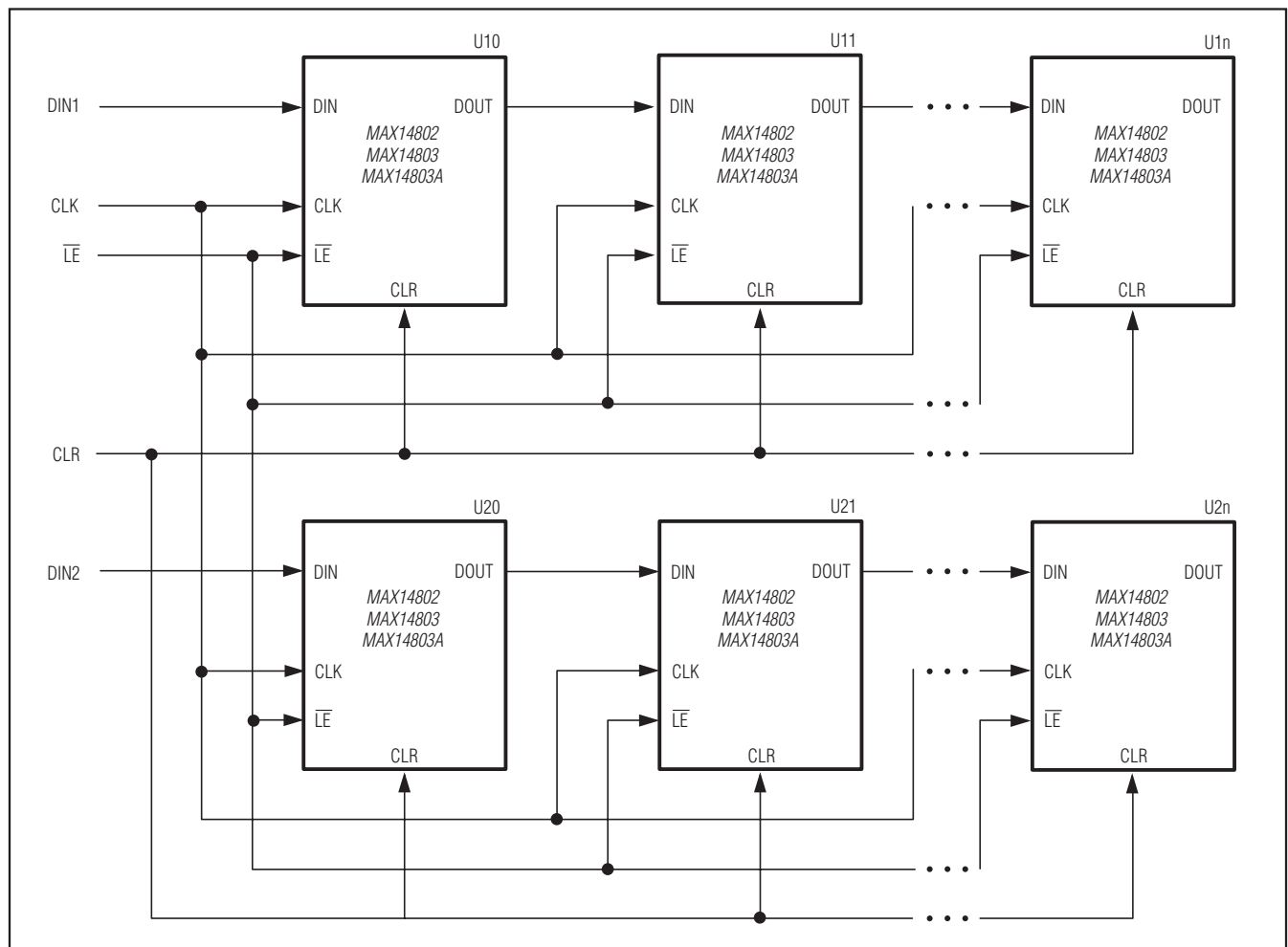

Figure 3. Interfacing Multiple Devices by Daisy-Chaining

# MAX14802/MAX14803/MAX14803A

## Low-Charge Injection, 16-Channel, High-Voltage Analog Switches

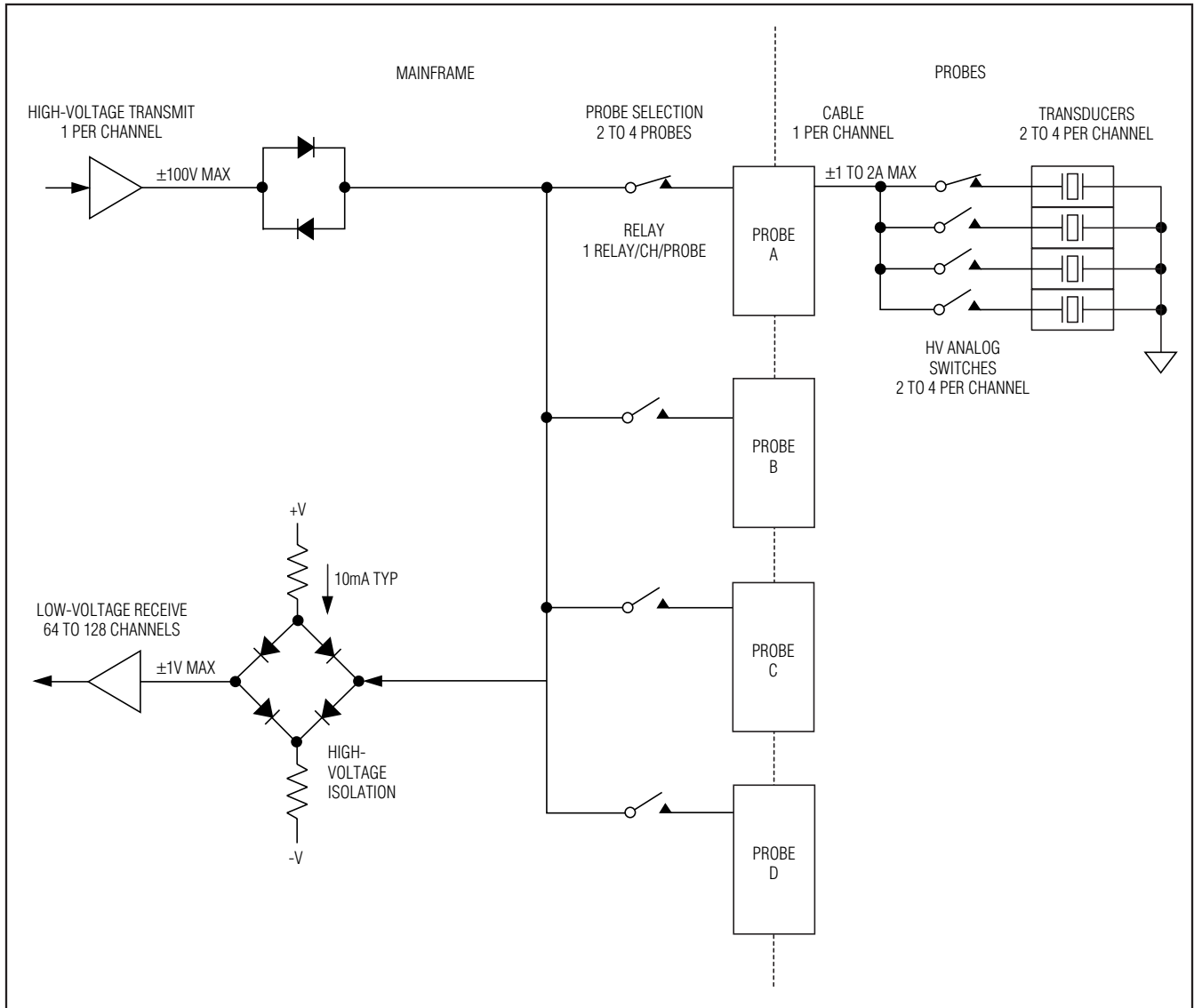

Figure 4. Medical Ultrasound Application—High-Voltage Analog Switches in Probe

# MAX14802/MAX14803/MAX14803A

## Low-Charge Injection, 16-Channel, High-Voltage Analog Switches



Figure 5. Medical Ultrasound Application—High-Voltage Analog Switches in Mainframe

# MAX14802/MAX14803/MAX14803A

## Low-Charge Injection, 16-Channel, High-Voltage Analog Switches



Figure 6. Medical Ultrasound Application—Multiple Transmit and Isolation per Receiver Channel



# MAX14802/MAX14803/MAX14803A

## Low-Charge Injection, 16-Channel, High-Voltage Analog Switches

### Functional Diagram



# MAX14802/MAX14803/MAX14803A

## Low-Charge Injection, 16-Channel, High-Voltage Analog Switches

### Pin Configurations

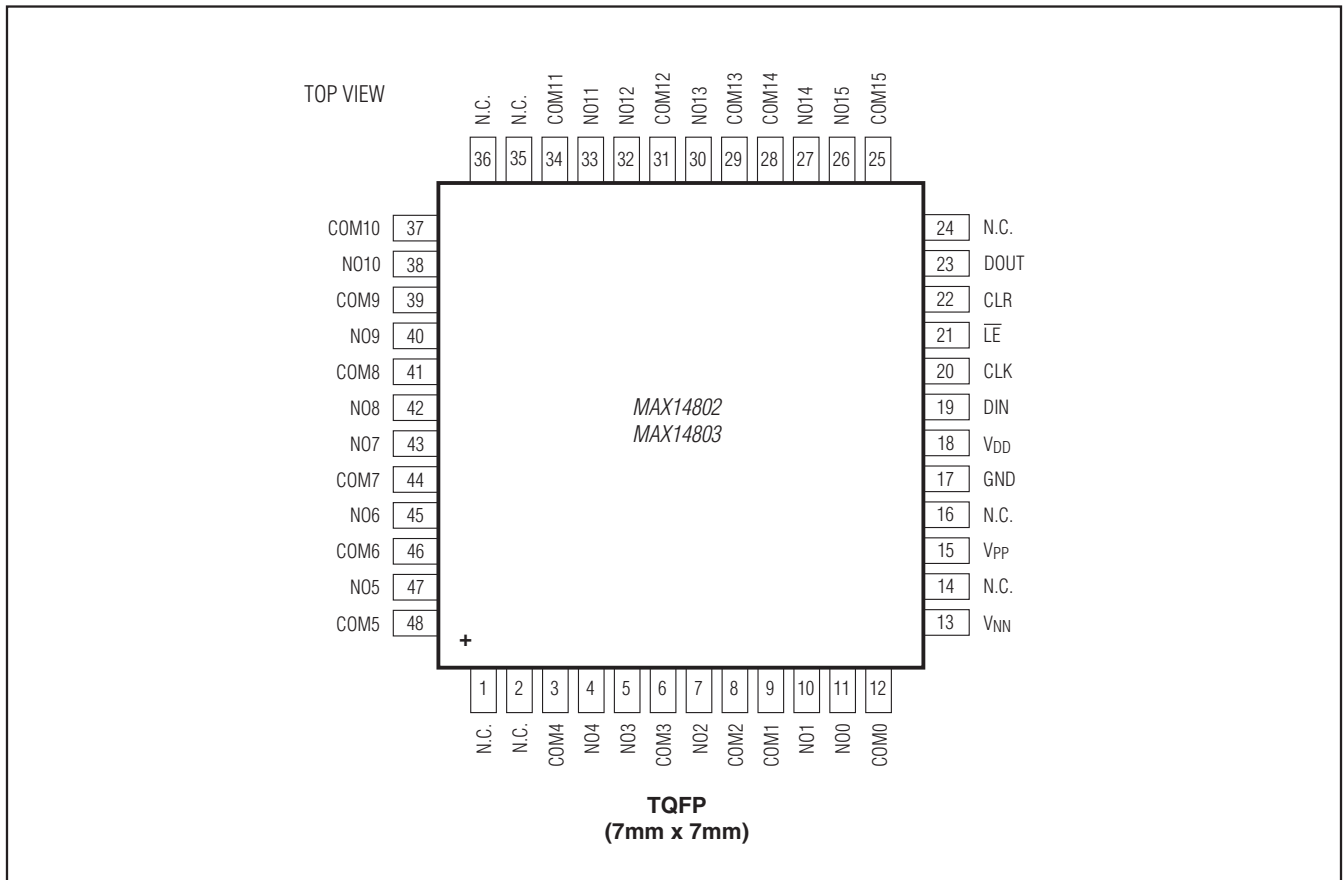

# MAX14802/MAX14803/MAX14803A

## Low-Charge Injection, 16-Channel, High-Voltage Analog Switches

### Pin Configurations (continued)

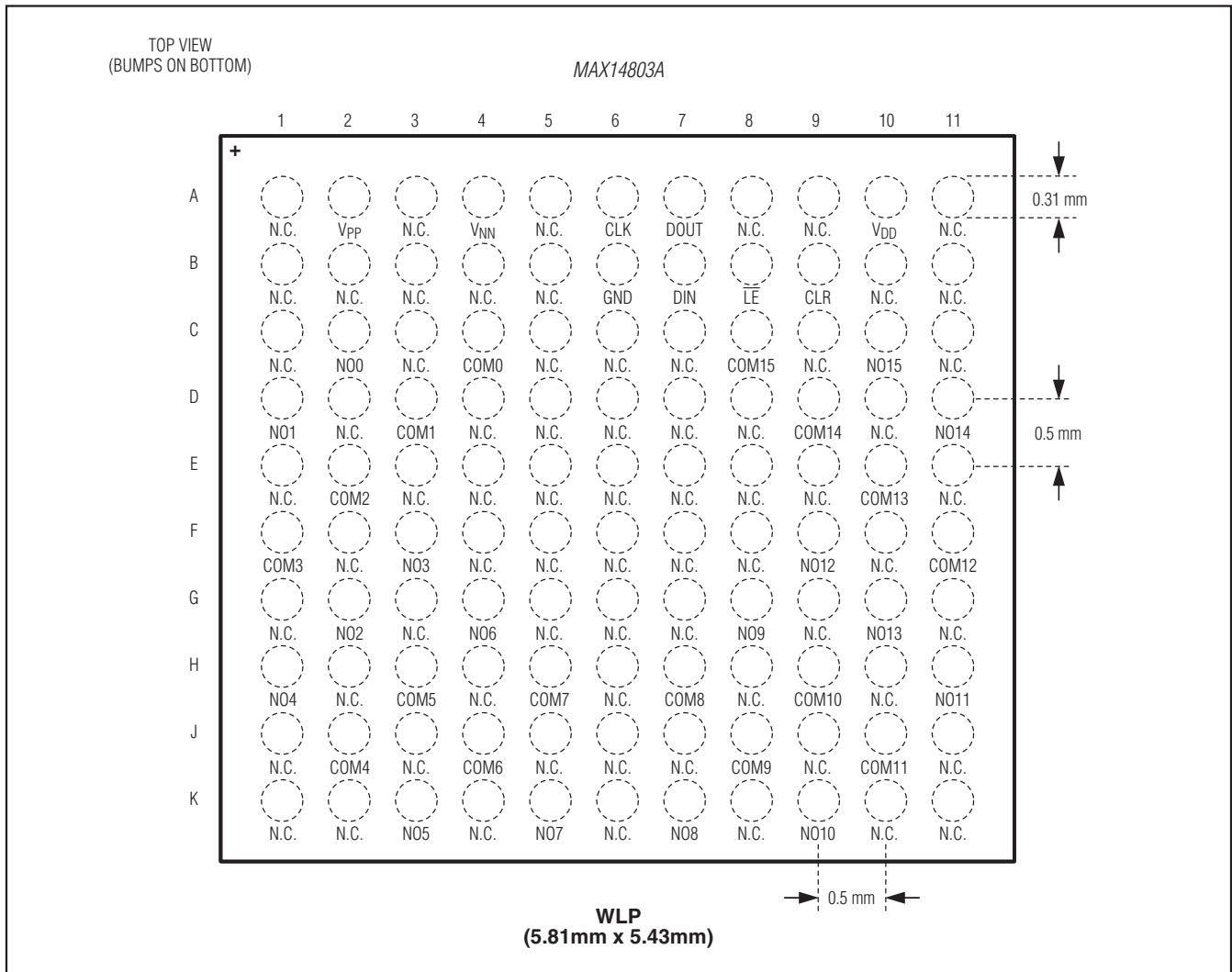

### Chip Information

PROCESS: BICMOS

### Package Information

For the latest package outline information and land patterns (footprints), go to [www.maximintegrated.com/packages](http://www.maximintegrated.com/packages). Note that a "+", "#", or "-" in the package code indicates RoHS status only. Package drawings may show a different suffix character, but the drawing pertains to the package regardless of RoHS status.

PACKAGE TYPE	PACKAGE CODE	OUTLINE NO.	LAND PATTERN NO.
48 TQFP	C48+6	<a href="#">21-0054</a>	<a href="#">90-0093</a>
110 WLP	W1105B5+1	<a href="#">21-0494</a>	Refer to <a href="#">Application Note 1891</a>

# MAX14802/MAX14803/MAX14803A

## Low-Charge Injection, 16-Channel, High-Voltage Analog Switches

### Revision History

REVISION NUMBER	REVISION DATE	DESCRIPTION	PAGES CHANGED
0	4/09	Initial release	—
1	9/09	Corrected two specifications in the <i>Absolute Maximum Ratings</i> section, changed the minimum of the peak-to-peak analog signal range to “either $V_{NN} + 200V$ or $(V_{PP} - 10V)$ ”	2, 9
2	11/10	Deleted the MAX14800/MAX14801 from the entire data sheet and added the MAX14803A; added the WLP part to the <i>Ordering Information</i> , <i>Pin Configurations</i> , <i>Pin Descriptions</i> , and <i>Package Information</i> sections	1–19
3	8/11	Added extended temperature information; added MAX14802ECM+ to data sheet	1
4	6/13	Updated <i>Absolute Maximum Ratings</i> and <i>Operating Supply Voltages</i>	1, 2



Maxim Integrated cannot assume responsibility for use of any circuitry other than circuitry entirely embodied in a Maxim Integrated product. No circuit patent licenses are implied. Maxim Integrated reserves the right to change the circuitry and specifications without notice at any time. The parametric values (min and max limits) shown in the Electrical Characteristics table are guaranteed. Other parametric values quoted in this data sheet are provided for guidance.

## Данный компонент на территории Российской Федерации

### Вы можете приобрести в компании MosChip.

Для оперативного оформления запроса Вам необходимо перейти по данной ссылке:

<http://moschip.ru/get-element>

Вы можете разместить у нас заказ для любого Вашего проекта, будь то серийное производство или разработка единичного прибора.

В нашем ассортименте представлены ведущие мировые производители активных и пассивных электронных компонентов.

Нашей специализацией является поставка электронной компонентной базы двойного назначения, продукции таких производителей как XILINX, Intel (ex.ALTERA), Vicor, Microchip, Texas Instruments, Analog Devices, Mini-Circuits, Amphenol, Glenair.

Сотрудничество с глобальными дистрибьюторами электронных компонентов, предоставляет возможность заказывать и получать с международных складов практически любой перечень компонентов в оптимальные для Вас сроки.

На всех этапах разработки и производства наши партнеры могут получить квалифицированную поддержку опытных инженеров.

Система менеджмента качества компании отвечает требованиям в соответствии с ГОСТ Р ИСО 9001, ГОСТ РВ 0015-002 и ЭС РД 009

### Офис по работе с юридическими лицами:

105318, г.Москва, ул.Щербаковская д.3, офис 1107, 1118, ДЦ «Щербаковский»

Телефон: +7 495 668-12-70 (многоканальный)

Факс: +7 495 668-12-70 (доб.304)

E-mail: [info@moschip.ru](mailto:info@moschip.ru)

Skype отдела продаж:

moschip.ru

moschip.ru\_4

moschip.ru\_6

moschip.ru\_9