

Series: Jaguar

Description: 3G/4G LTE 2xMiMo Vehicular Antenna

PART NUMBER: W1919

Features:

- 698-960/1710-3800MHz
- Extremely compact size LTE MiMo Antenna
 - 78.2 x 78.2 x 30.3mm
- Standard cable length 3m with SMA Male connectors
- IP67
- Mounting with adhesive tape

Applications:

- Indoor and outdoor use
- 2G/3G/4G radios
- 2xLTE MiMo
- 3G Main + Diversity
- Vehicular, Telematics, Transportation
- Cellular access points



All dimensions are in mm / inches

Issue: 1748P

In the effort to improve our products, we reserve the right to make changes judged to be necessary.

CONFIDENTIAL AND PROPRIETARY INFORMATION

This document contains confidential and proprietary information of Pulse Electronics, Inc. (Pulse) and is protected by copyright, trade secret and other state and federal laws. Its receipt or possession does not convey any rights to reproduce, disclose its contents, or to manufacture, use or sell anything it may describe. Reproduction, disclosure or use without specific written authorization of Pulse is strictly forbidden.

For more information:

Pulse Worldwide Headquarters
15255 Innovation Drive #100
San Diego, CA 92128
USA
Tel: 1-858-674-8100

Pulse/Larsen Antennas
18110 SE 34th St Bldg 2 Suite 250
Vancouver, WA 98683
USA
Tel: 1-360-944-7551

Europe Headquarters
Pulse GmbH & Do, KG
Zeppelinstrasse 15
Herrenberg, Germany
Tel: 49 7032 7806 0

Pulse (Suzhou) Wireless Products Co, Inc.
99 Huo Ju Road(#29 Bldg,4th Phase
Suzhou New District
Jiangsu Province, Suzhou 215009 PR China
Tel: 86 512 6807 9998

Preliminary



Description: 3G/4G LTE 2xMiMo Vehicular Antenna

Series: Jaguar

PART NUMBER: W1919

ELECTRICAL SPECIFICATIONS

Frequency	698-960 MHz / 1710-2690MHz/3400-3800MHz
Nominal Impedance	50 Ω
Return Loss	-10 dB
Isolation	-15 dB
Radiation Pattern	Omni
Gain	-0.42dBi @698-960MHz 1.77dBi @1710-2690MHz 1.76dBi @3400-3800MHz
Polarization	Vertical
Power Withstanding	5W

MECHANICAL SPECIFICATIONS

Overall Length	78.2mm
Weight	142g
Antenna Color / Material	Black, PC
Connector type	SMA Male
Cable type	RG174, Black
Cable length	3000mm

ENVIRONMENTAL SPECIFICATIONS

Operating Temperature	-40 ~ +85° C
Storage Temperature	-40 ~ +85° C
Ingress Protection	IP67
RoHS Compliant	Yes

Preliminary

Issue: 1748P

In the effort to improve our products, we reserve the right to make changes judged to be necessary.

CONFIDENTIAL AND PROPRIETARY INFORMATION

This document contains confidential and proprietary information of Pulse Electronics, Inc. (Pulse) and is protected by copyright, trade secret and other state and federal laws. Its receipt or possession does not convey any rights to reproduce, disclose its contents, or to manufacture, use or sell anything it may describe. Reproduction, disclosure or use without specific written authorization of Pulse is strictly forbidden.



Description: 3G/4G LTE 2xMiMo Vehicular Antenna

Series: Jaguar

PART NUMBER: W1919

MECHANICAL DRAWING

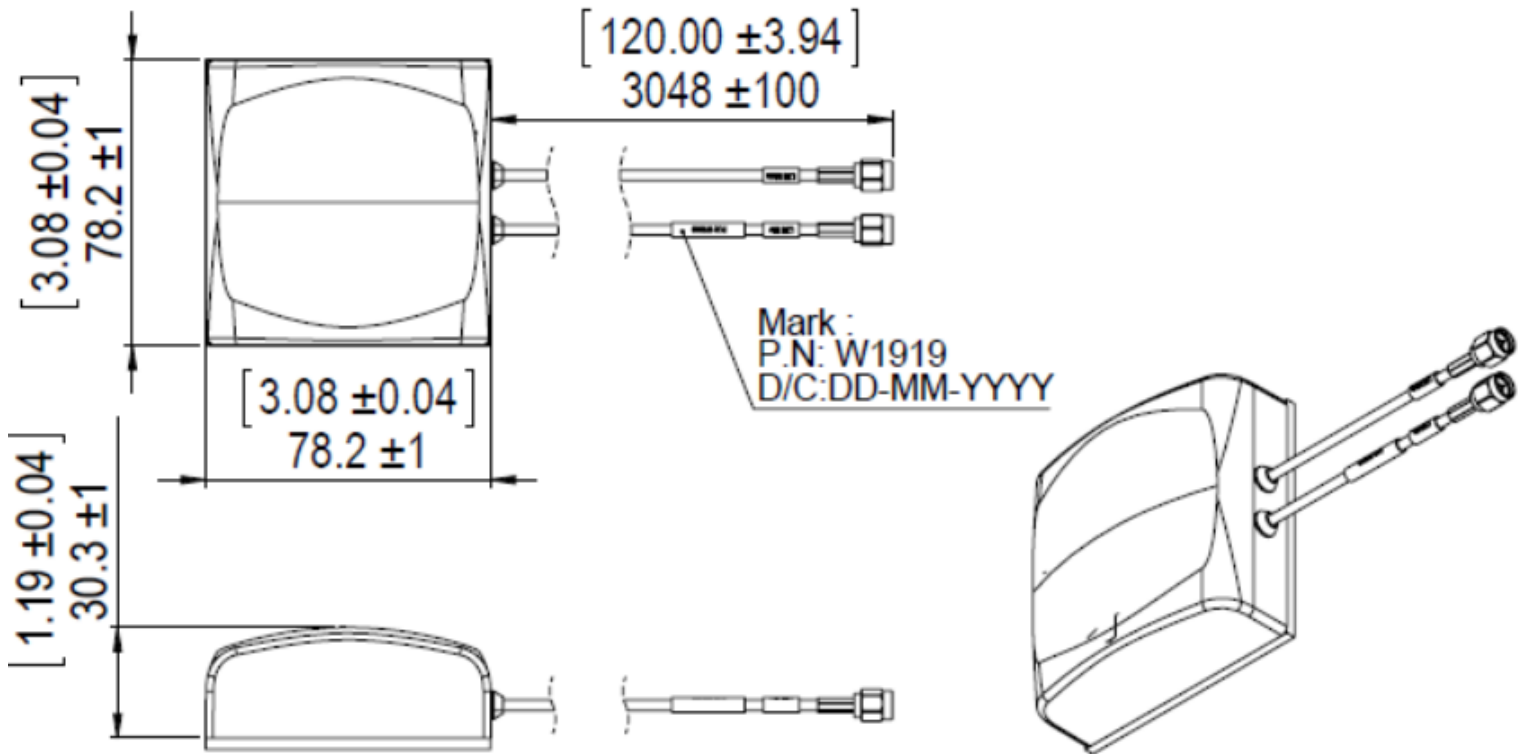

Part NO.	CABLE LENGTH	LTE Main Cable	LTE Div Cable	APPEARANCE COLOR	MOUNTING
W1919	3M(118.11")	RG174+SMA Male	RG174+SMA Male	Black	Adhesive Mount

Issue: 1748P

In the effort to improve our products, we reserve the right to make changes judged to be necessary.

CONFIDENTIAL AND PROPRIETARY INFORMATION

This document contains confidential and proprietary information of Pulse Electronics, Inc. (Pulse) and is protected by copyright, trade secret and other state and federal laws. Its receipt or possession does not convey any rights to reproduce, disclose its contents, or to manufacture, use or sell anything it may describe. Reproduction, disclosure or use without specific written authorization of Pulse is strictly forbidden.

Preliminary



Description: 3G/4G LTE 2xMiMo Vehicular Antenna

Series: Jaguar

PART NUMBER: W1919

CHARTS

Return Loss

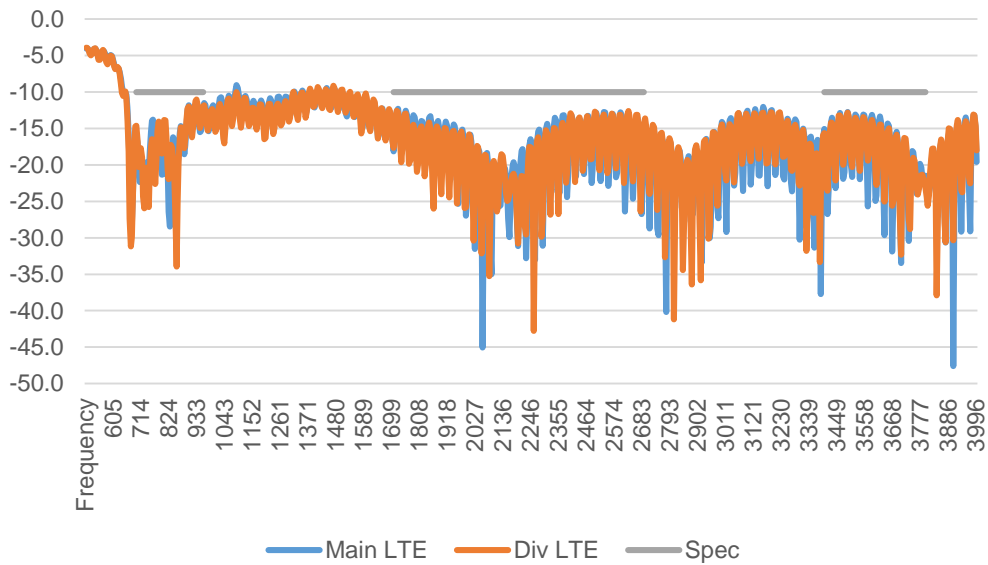

Isolation

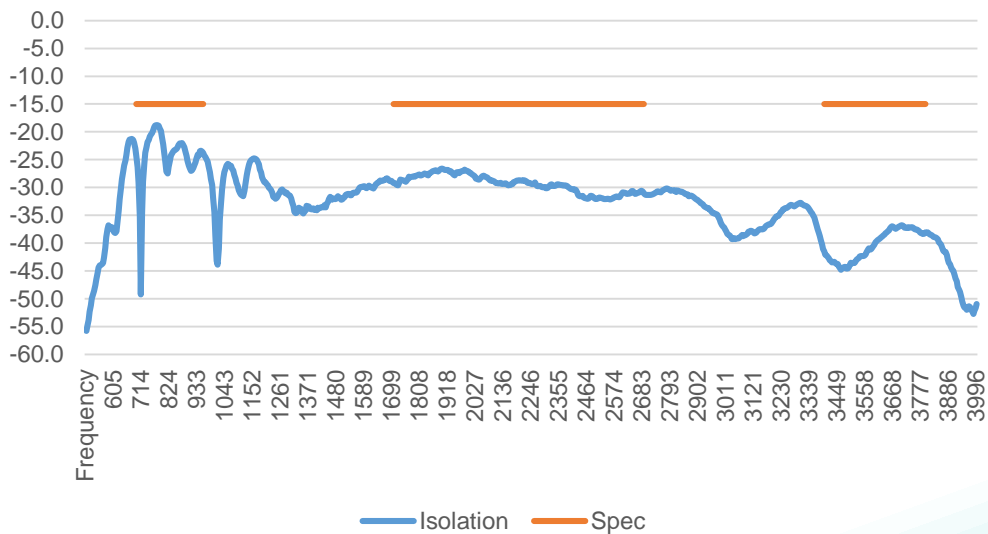

Note : Antenna measured with 10ft cable

Issue: 1748P

In the effort to improve our products, we reserve the right to make changes judged to be necessary.

CONFIDENTIAL AND PROPRIETARY INFORMATION

This document contains confidential and proprietary information of Pulse Electronics, Inc. (Pulse) and is protected by copyright, trade secret and other state and federal laws. Its receipt or possession does not convey any rights to reproduce, disclose its contents, or to manufacture, use or sell anything it may describe. Reproduction, disclosure or use without specific written authorization of Pulse is strictly forbidden.

Preliminary



Description: 3G/4G LTE 2xMiMo Vehicular Antenna

Series: Jaguar

PART NUMBER: W1919

CHARTS

Efficiency(%)

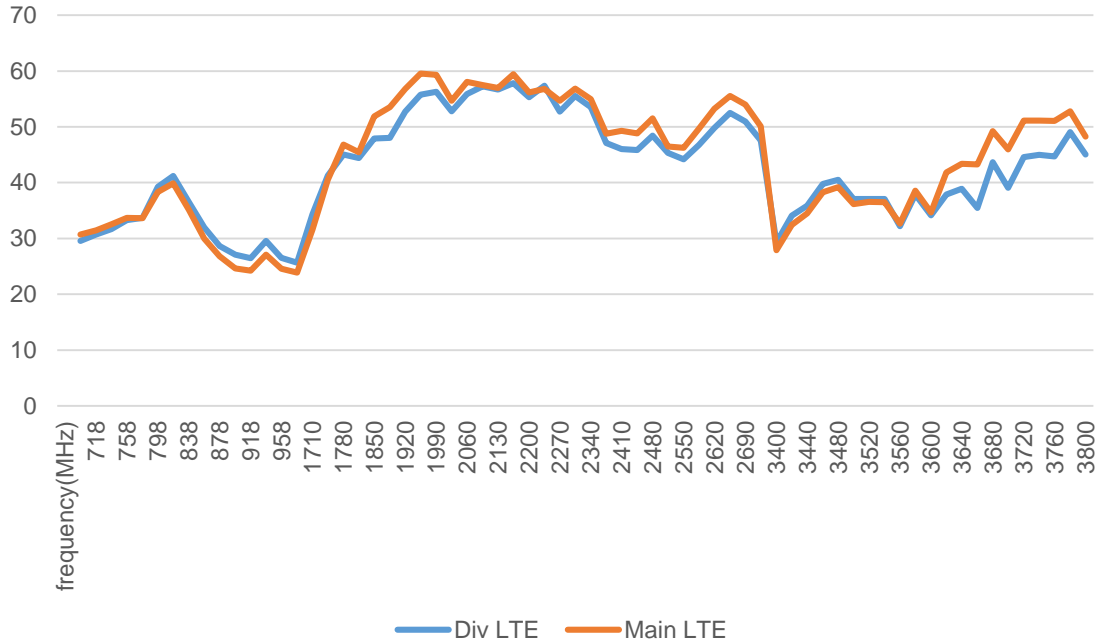

Peak Gain(dBi)

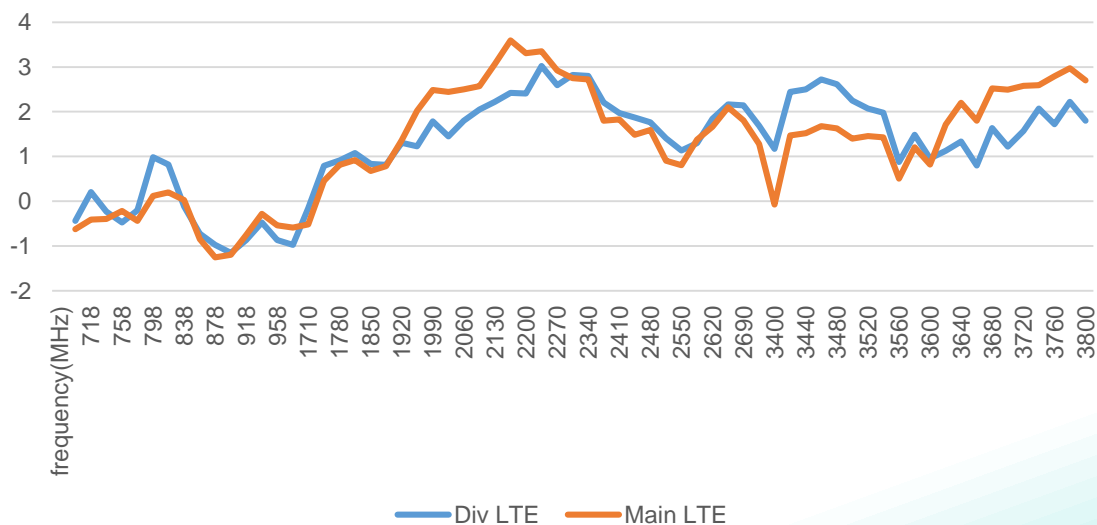

Note : Antenna measured in free space with 150mm cable

Issue: 1748P

In the effort to improve our products, we reserve the right to make changes judged to be necessary.

CONFIDENTIAL AND PROPRIETARY INFORMATION

This document contains confidential and proprietary information of Pulse Electronics, Inc. (Pulse) and is protected by copyright, trade secret and other state and federal laws. Its receipt or possession does not convey any rights to reproduce, disclose its contents, or to manufacture, use or sell anything it may describe. Reproduction, disclosure or use without specific written authorization of Pulse is strictly forbidden.

Preliminary



Description: 3G/4G LTE 2xMiMo Vehicular Antenna

Series: Jaguar

PART NUMBER: W1919

CHARTS

Gain Plots (Main LTE)

XY Plane

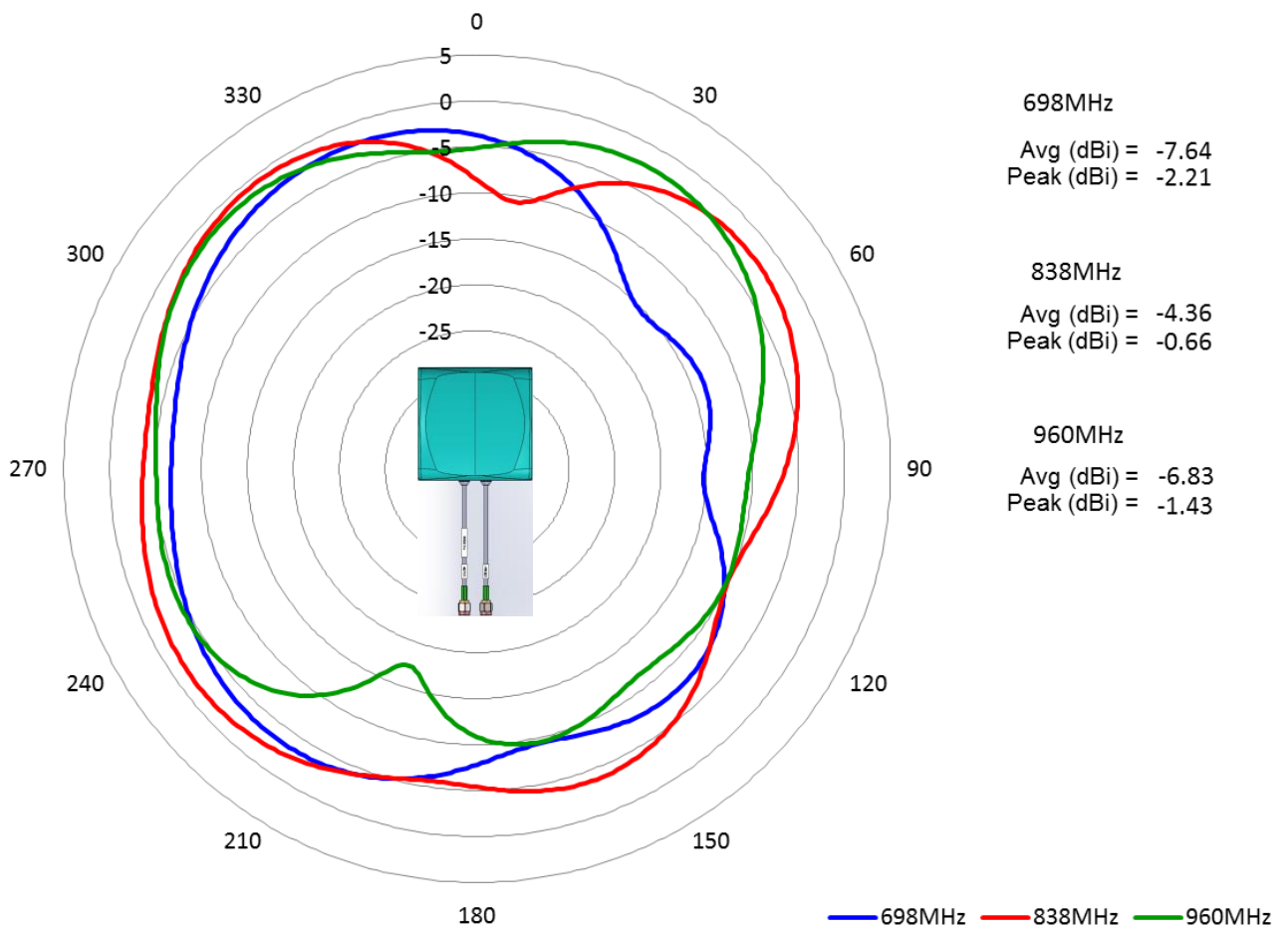

Note : Antenna measured in free space with 150mm cable

Issue: 1748P

In the effort to improve our products, we reserve the right to make changes judged to be necessary.
CONFIDENTIAL AND PROPRIETARY INFORMATION

This document contains confidential and proprietary information of Pulse Electronics, Inc. (Pulse) and is protected by copyright, trade secret and other state and federal laws. Its receipt or possession does not convey any rights to reproduce, disclose its contents, or to manufacture, use or sell anything it may describe. Reproduction, disclosure or use without specific written authorization of Pulse is strictly forbidden.

Preliminary



Description: 3G/4G LTE 2xMiMo Vehicular Antenna

Series: Jaguar

PART NUMBER: W1919

CHARTS

Gain Plots (Main LTE)

ZX Plane

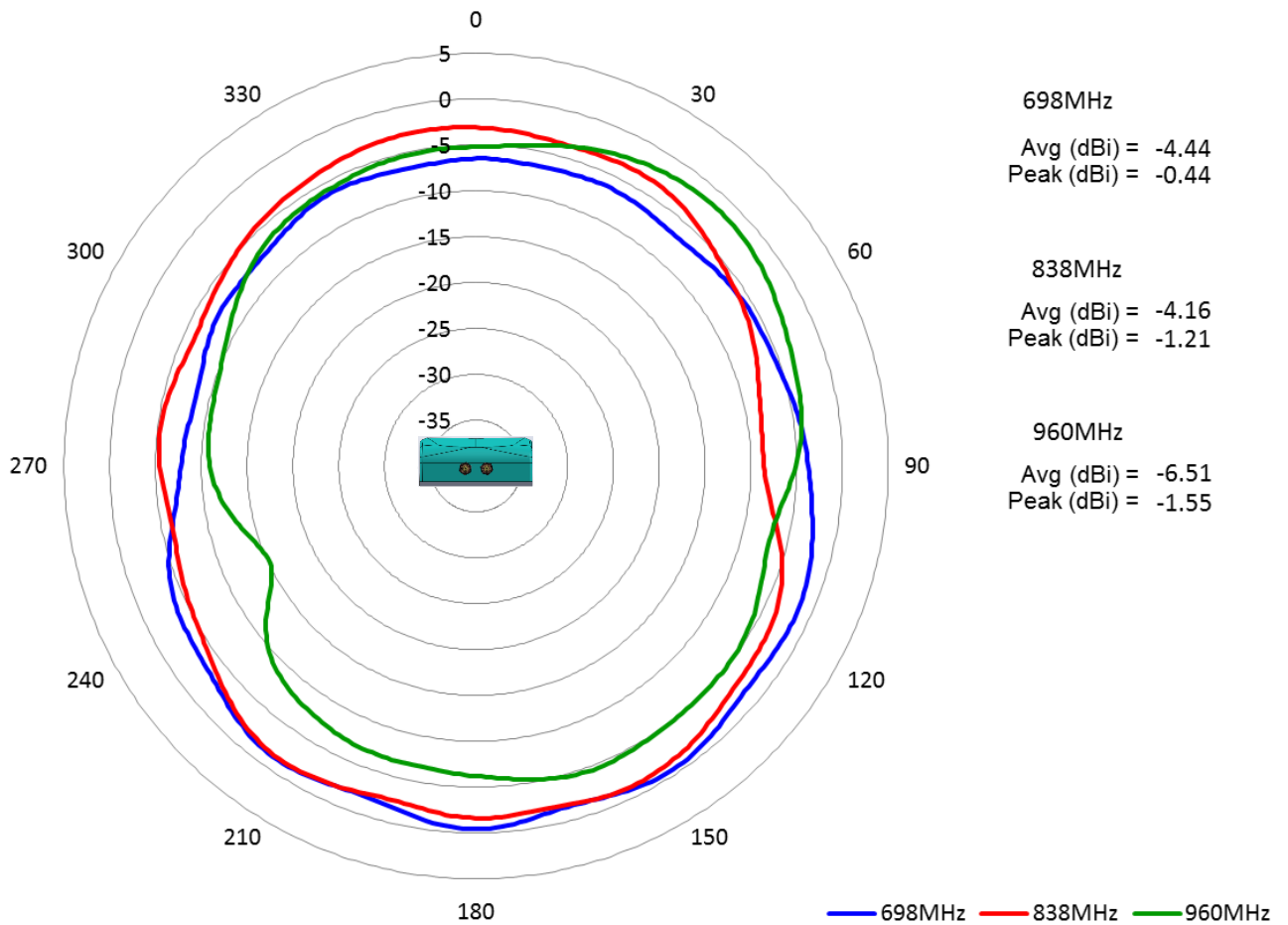

Note : Antenna measured in free space with 150mm cable

Issue: 1748P

In the effort to improve our products, we reserve the right to make changes judged to be necessary.
CONFIDENTIAL AND PROPRIETARY INFORMATION

This document contains confidential and proprietary information of Pulse Electronics, Inc. (Pulse) and is protected by copyright, trade secret and other state and federal laws. Its receipt or possession does not convey any rights to reproduce, disclose its contents, or to manufacture, use or sell anything it may describe. Reproduction, disclosure or use without specific written authorization of Pulse is strictly forbidden.

Preliminary



Description: 3G/4G LTE 2xMiMo Vehicular Antenna

Series: Jaguar

PART NUMBER: W1919

CHARTS

Gain Plots (Main LTE)

ZY Plane

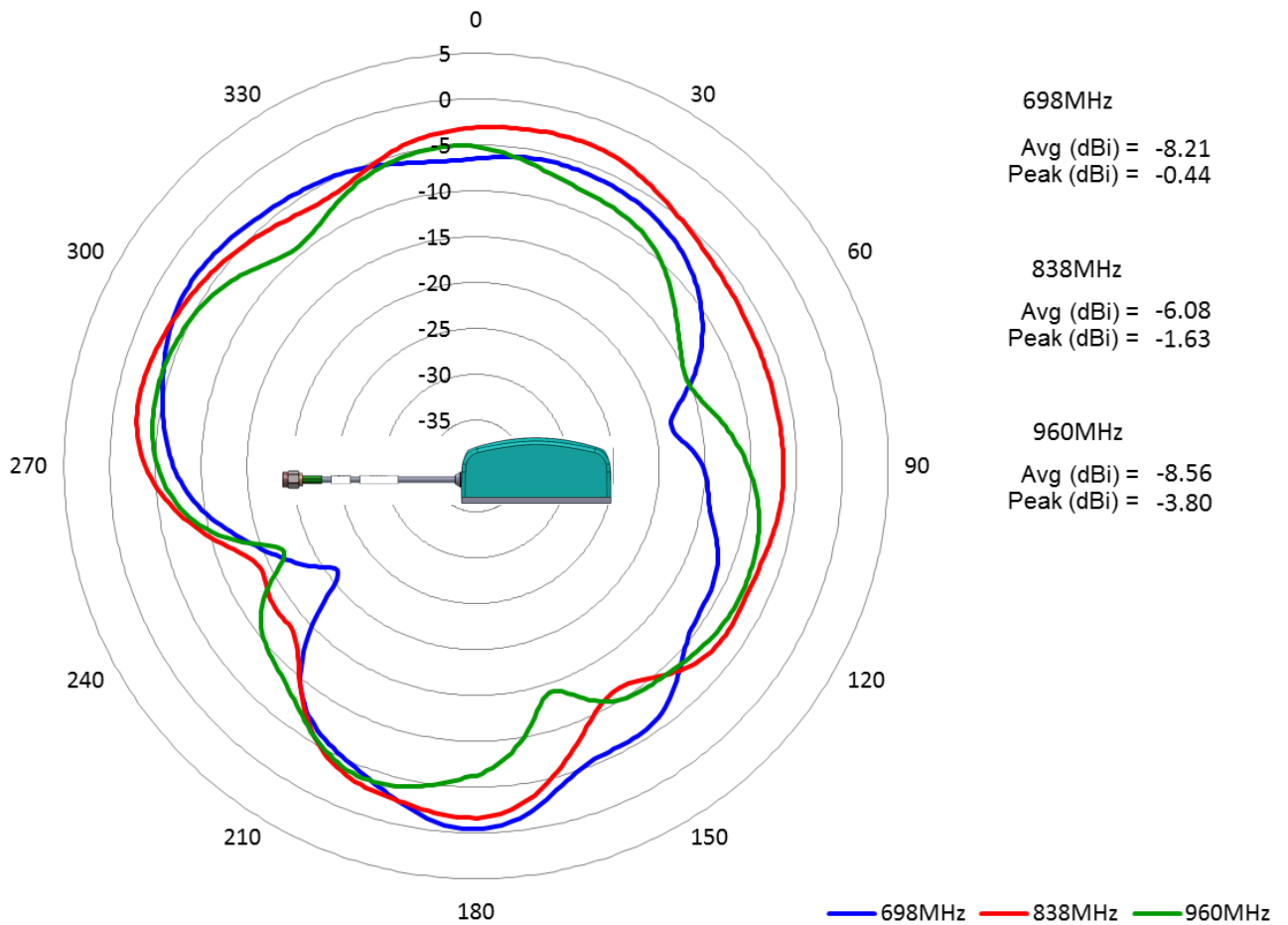

Note : Antenna measured in free space with 150mm cable

Issue: 1748P

In the effort to improve our products, we reserve the right to make changes judged to be necessary.
CONFIDENTIAL AND PROPRIETARY INFORMATION

This document contains confidential and proprietary information of Pulse Electronics, Inc. (Pulse) and is protected by copyright, trade secret and other state and federal laws. Its receipt or possession does not convey any rights to reproduce, disclose its contents, or to manufacture, use or sell anything it may describe. Reproduction, disclosure or use without specific written authorization of Pulse is strictly forbidden.

Preliminary



Description: 3G/4G LTE 2xMiMo Vehicular Antenna

Series: Jaguar

PART NUMBER: W1919

CHARTS

Gain Plots (Main LTE)

XY Plane

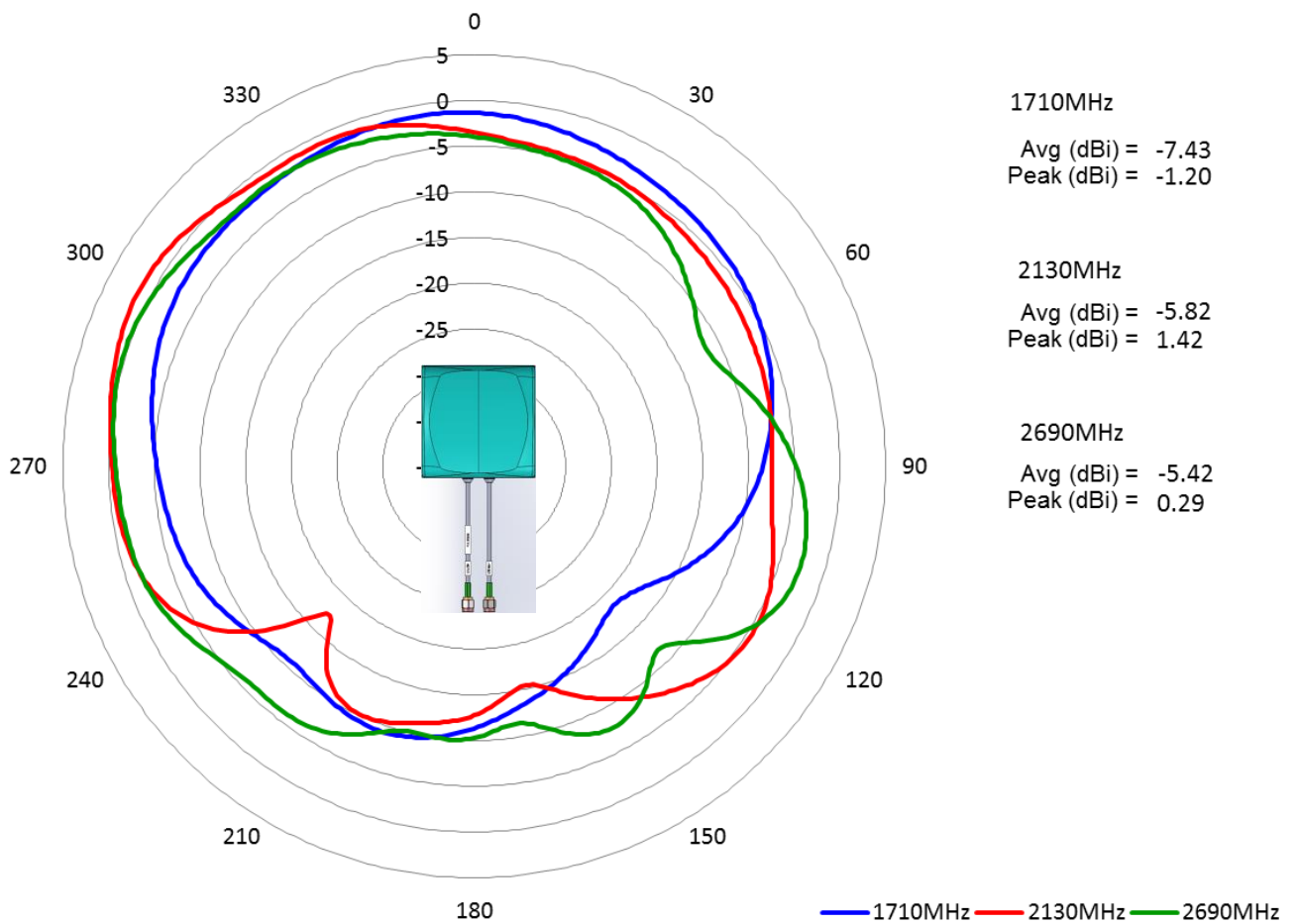

Note : Antenna measured in free space with 150mm cable

Issue: 1748P

In the effort to improve our products, we reserve the right to make changes judged to be necessary.

CONFIDENTIAL AND PROPRIETARY INFORMATION

This document contains confidential and proprietary information of Pulse Electronics, Inc. (Pulse) and is protected by copyright, trade secret and other state and federal laws. Its receipt or possession does not convey any rights to reproduce, disclose its contents, or to manufacture, use or sell anything it may describe. Reproduction, disclosure or use without specific written authorization of Pulse is strictly forbidden.

Preliminary



Description: 3G/4G LTE 2xMiMo Vehicular Antenna

Series: Jaguar

PART NUMBER: W1919

CHARTS

Gain Plots (Main LTE)

ZX Plane

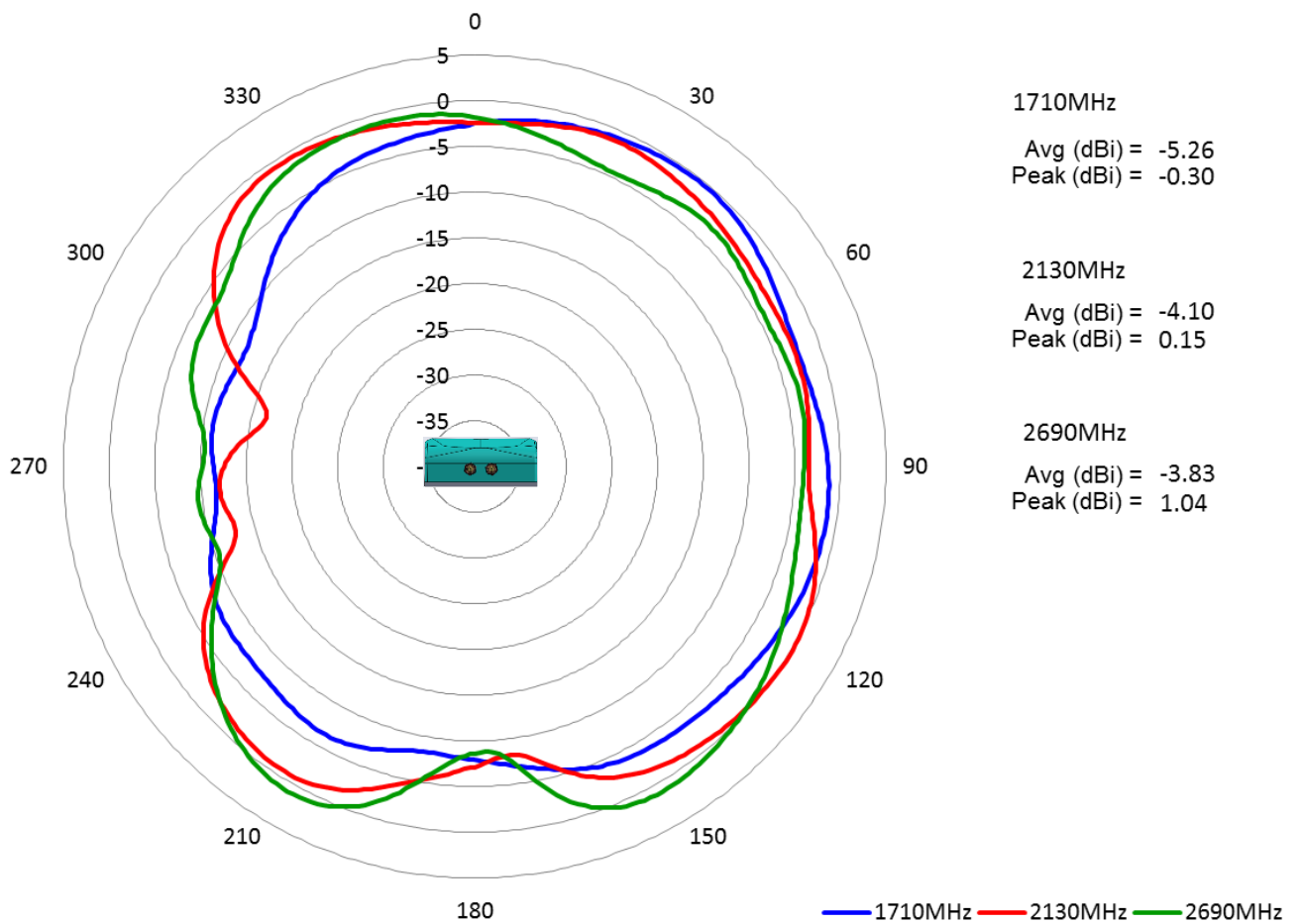

Note : Antenna measured in free space with 150mm cable

Issue: 1748P

In the effort to improve our products, we reserve the right to make changes judged to be necessary.
CONFIDENTIAL AND PROPRIETARY INFORMATION

This document contains confidential and proprietary information of Pulse Electronics, Inc. (Pulse) and is protected by copyright, trade secret and other state and federal laws. Its receipt or possession does not convey any rights to reproduce, disclose its contents, or to manufacture, use or sell anything it may describe. Reproduction, disclosure or use without specific written authorization of Pulse is strictly forbidden.

Preliminary



Description: 3G/4G LTE 2xMiMo Vehicular Antenna

Series: Jaguar

PART NUMBER: W1919

CHARTS

Gain Plots (Main LTE)

ZY Plane

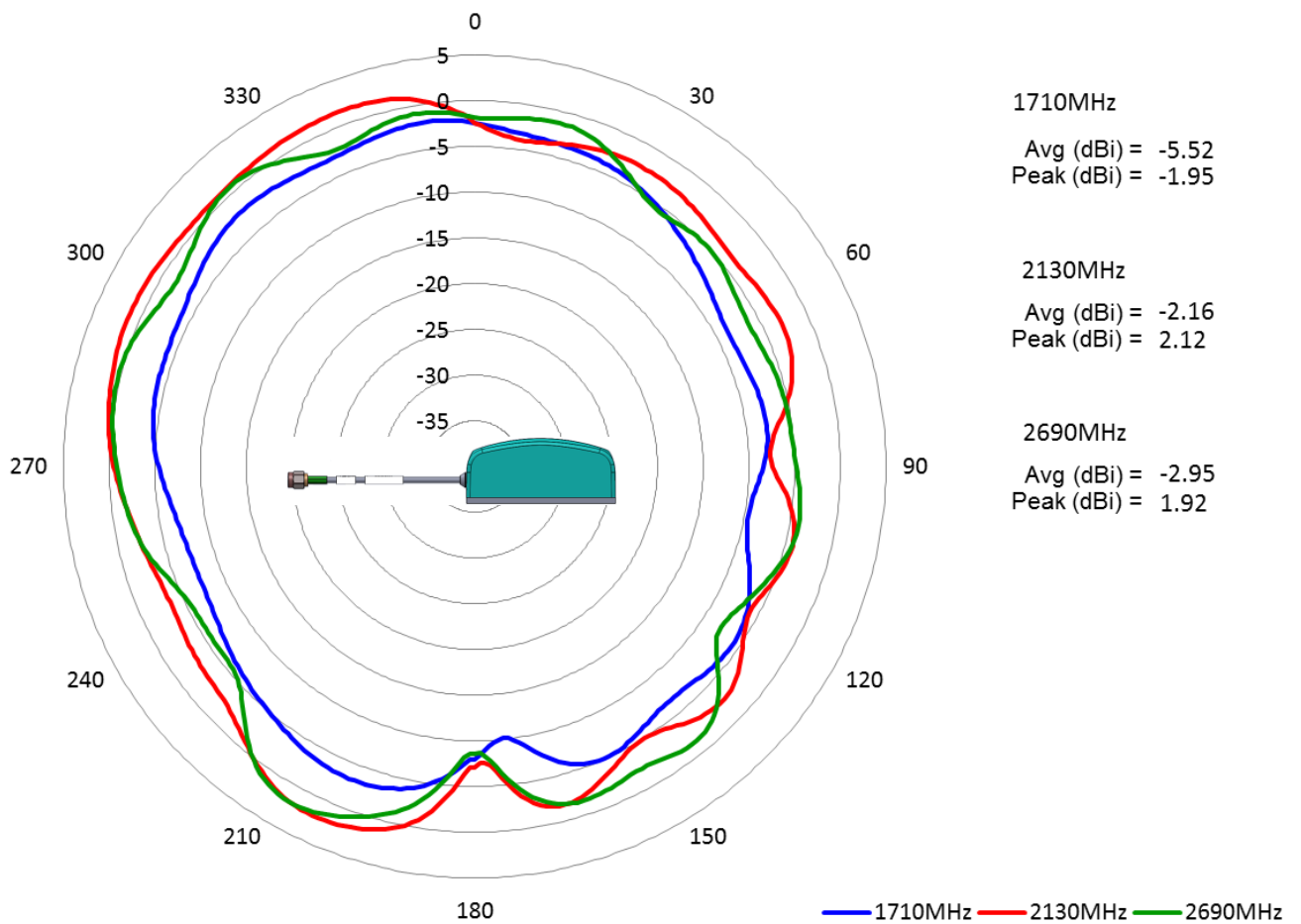

Note : Antenna measured in free space with 150mm cable

Issue: 1748P

In the effort to improve our products, we reserve the right to make changes judged to be necessary.
CONFIDENTIAL AND PROPRIETARY INFORMATION

This document contains confidential and proprietary information of Pulse Electronics, Inc. (Pulse) and is protected by copyright, trade secret and other state and federal laws. Its receipt or possession does not convey any rights to reproduce, disclose its contents, or to manufacture, use or sell anything it may describe. Reproduction, disclosure or use without specific written authorization of Pulse is strictly forbidden.

Preliminary



Description: 3G/4G LTE 2xMiMo Vehicular Antenna

Series: Jaguar

PART NUMBER: W1919

CHARTS

Gain Plots (Main LTE)

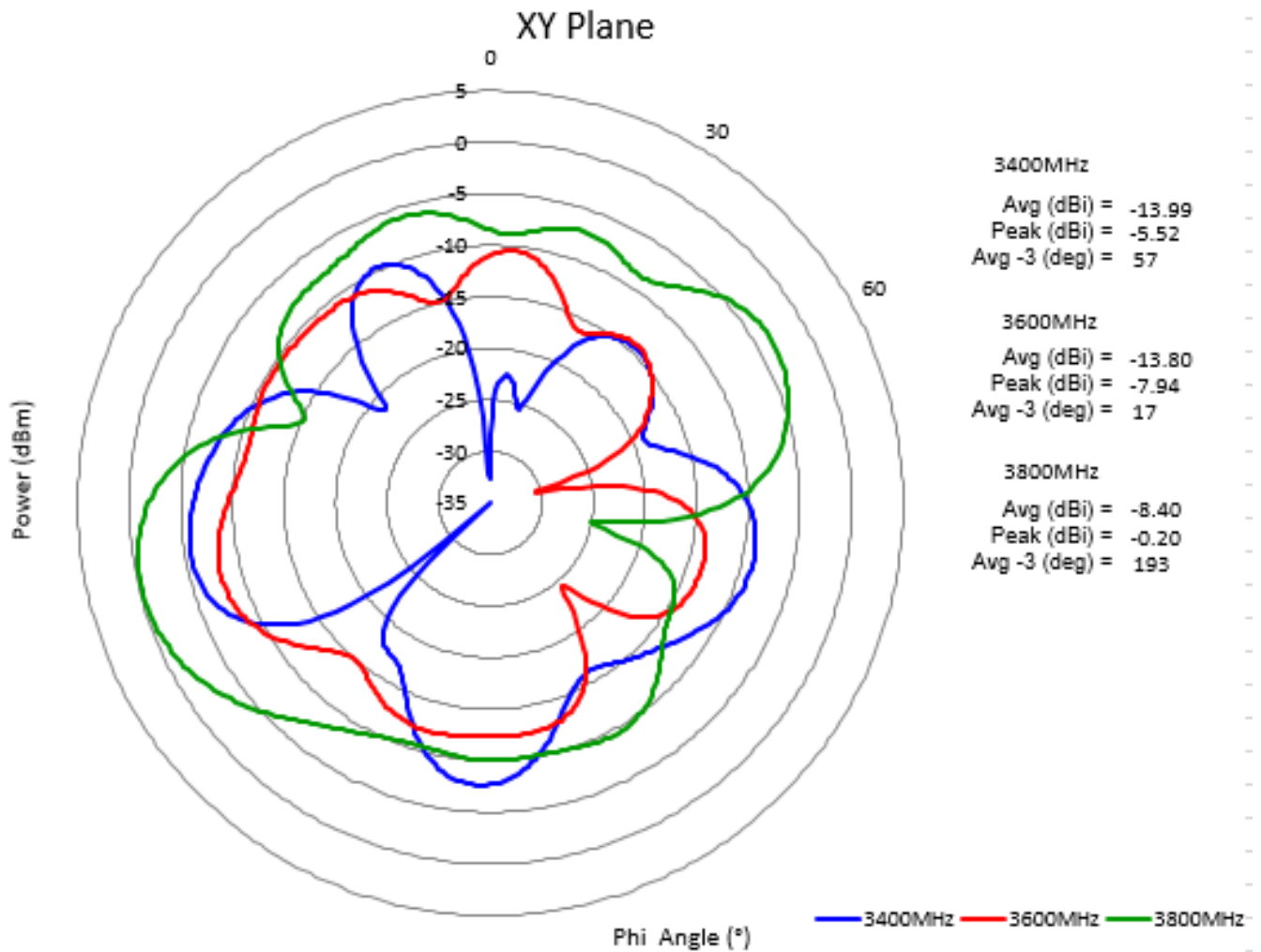

Note : Antenna measured in free space with 150mm cable

Issue: 1748P

In the effort to improve our products, we reserve the right to make changes judged to be necessary.
CONFIDENTIAL AND PROPRIETARY INFORMATION

This document contains confidential and proprietary information of Pulse Electronics, Inc. (Pulse) and is protected by copyright, trade secret and other state and federal laws. Its receipt or possession does not convey any rights to reproduce, disclose its contents, or to manufacture, use or sell anything it may describe. Reproduction, disclosure or use without specific written authorization of Pulse is strictly forbidden.

Preliminary

Description: 3G/4G LTE 2xMiMo Vehicular Antenna

Series: Jaguar

PART NUMBER: W1919

CHARTS

Gain Plots (Main LTE)

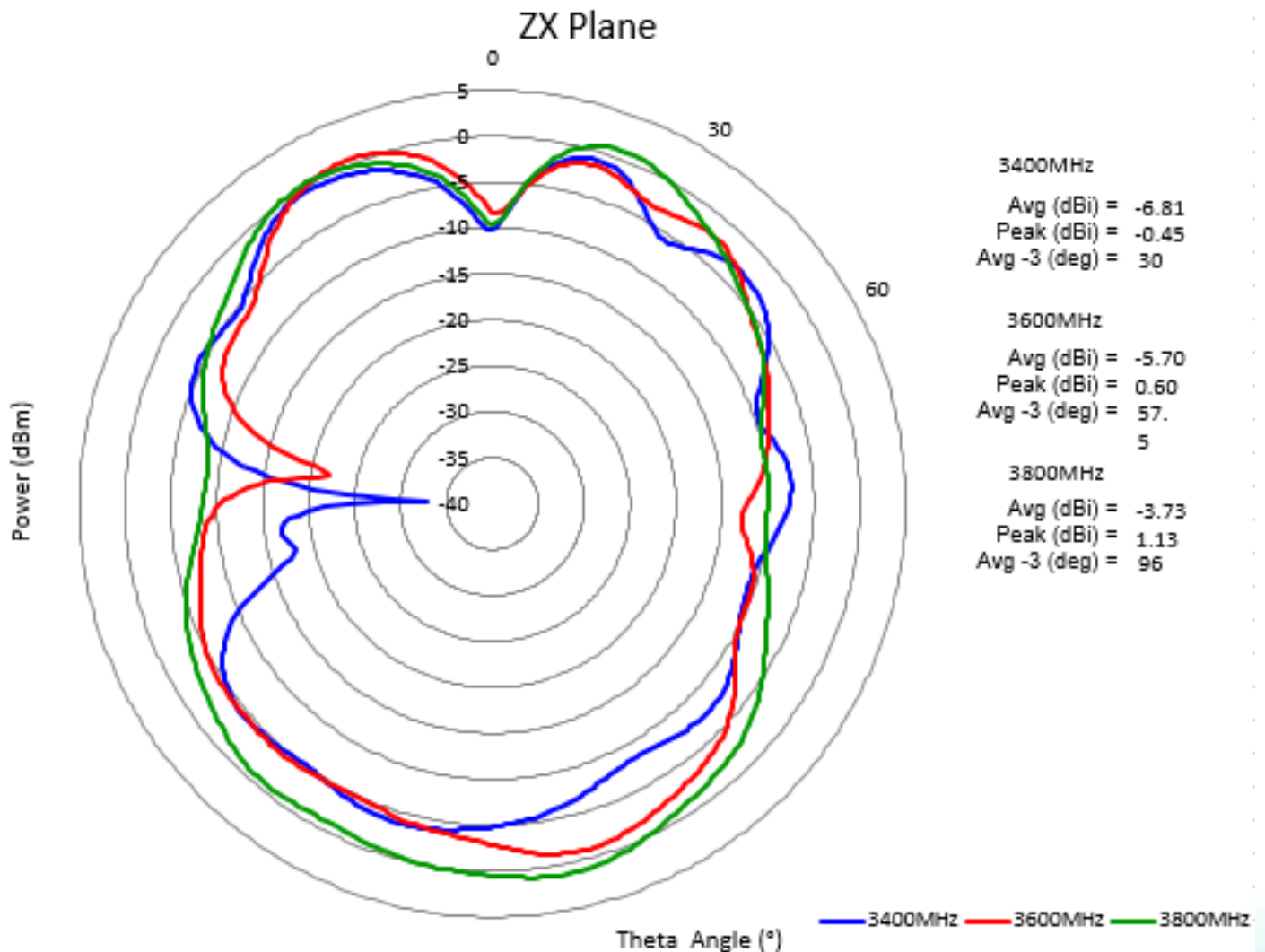

Note : Antenna measured in free space with 150mm cable

Issue: 1748P

In the effort to improve our products, we reserve the right to make changes judged to be necessary.
CONFIDENTIAL AND PROPRIETARY INFORMATION

This document contains confidential and proprietary information of Pulse Electronics, Inc. (Pulse) and is protected by copyright, trade secret and other state and federal laws. Its receipt or possession does not convey any rights to reproduce, disclose its contents, or to manufacture, use or sell anything it may describe. Reproduction, disclosure or use without specific written authorization of Pulse is strictly forbidden.

Preliminary

Description: 3G/4G LTE 2xMiMo Vehicular Antenna

Series: Jaguar

PART NUMBER: W1919

CHARTS

Gain Plots (Main LTE)

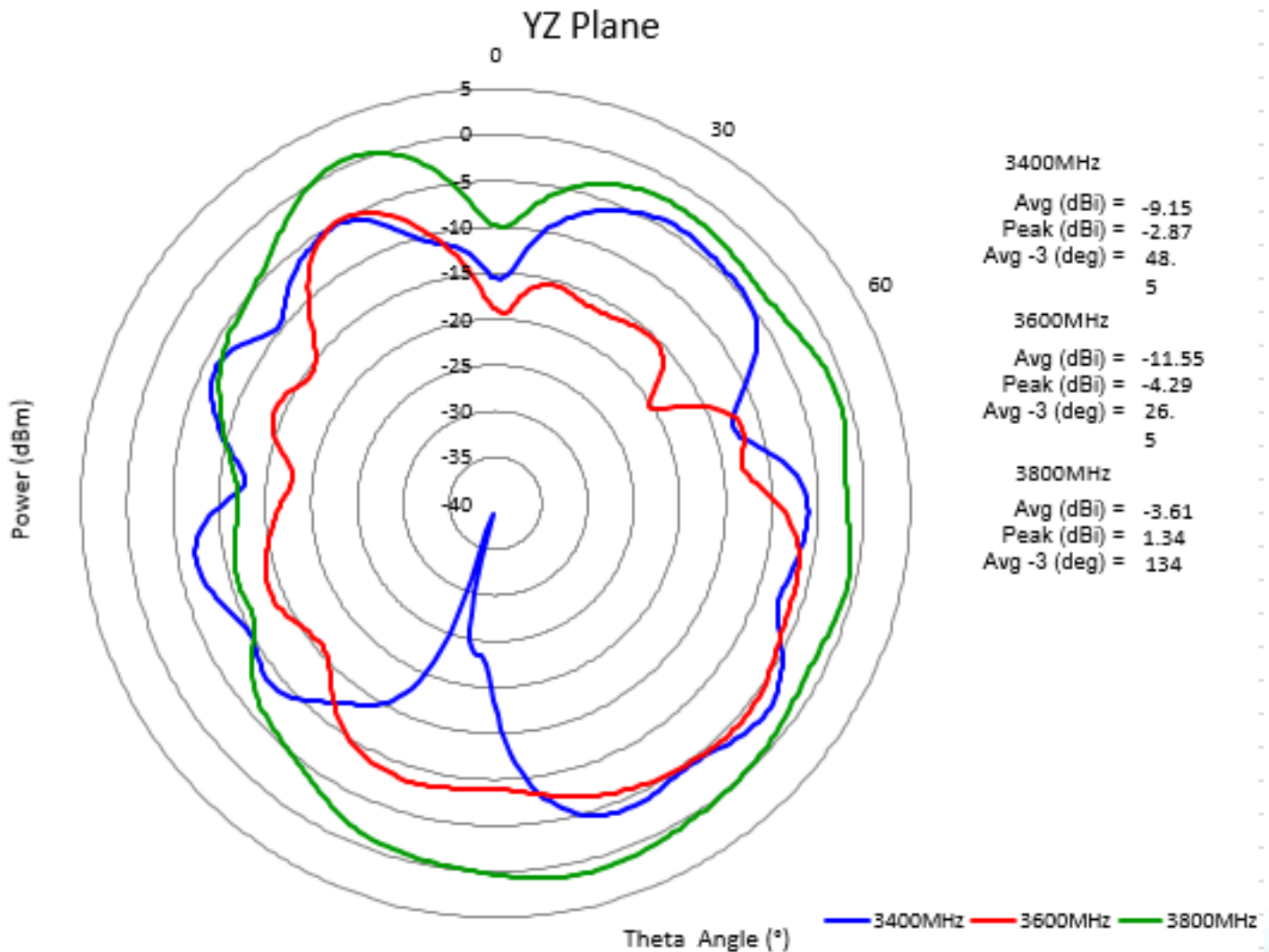

Note : Antenna measured in free space with 150mm cable

Issue: 1748P

In the effort to improve our products, we reserve the right to make changes judged to be necessary.
CONFIDENTIAL AND PROPRIETARY INFORMATION

This document contains confidential and proprietary information of Pulse Electronics, Inc. (Pulse) and is protected by copyright, trade secret and other state and federal laws. Its receipt or possession does not convey any rights to reproduce, disclose its contents, or to manufacture, use or sell anything it may describe. Reproduction, disclosure or use without specific written authorization of Pulse is strictly forbidden.

Preliminary

Description: 3G/4G LTE 2xMiMo Vehicular Antenna

Series: Jaguar

PART NUMBER: W1919

CHARTS

Gain Plots (Diversity LTE)

XY Plane

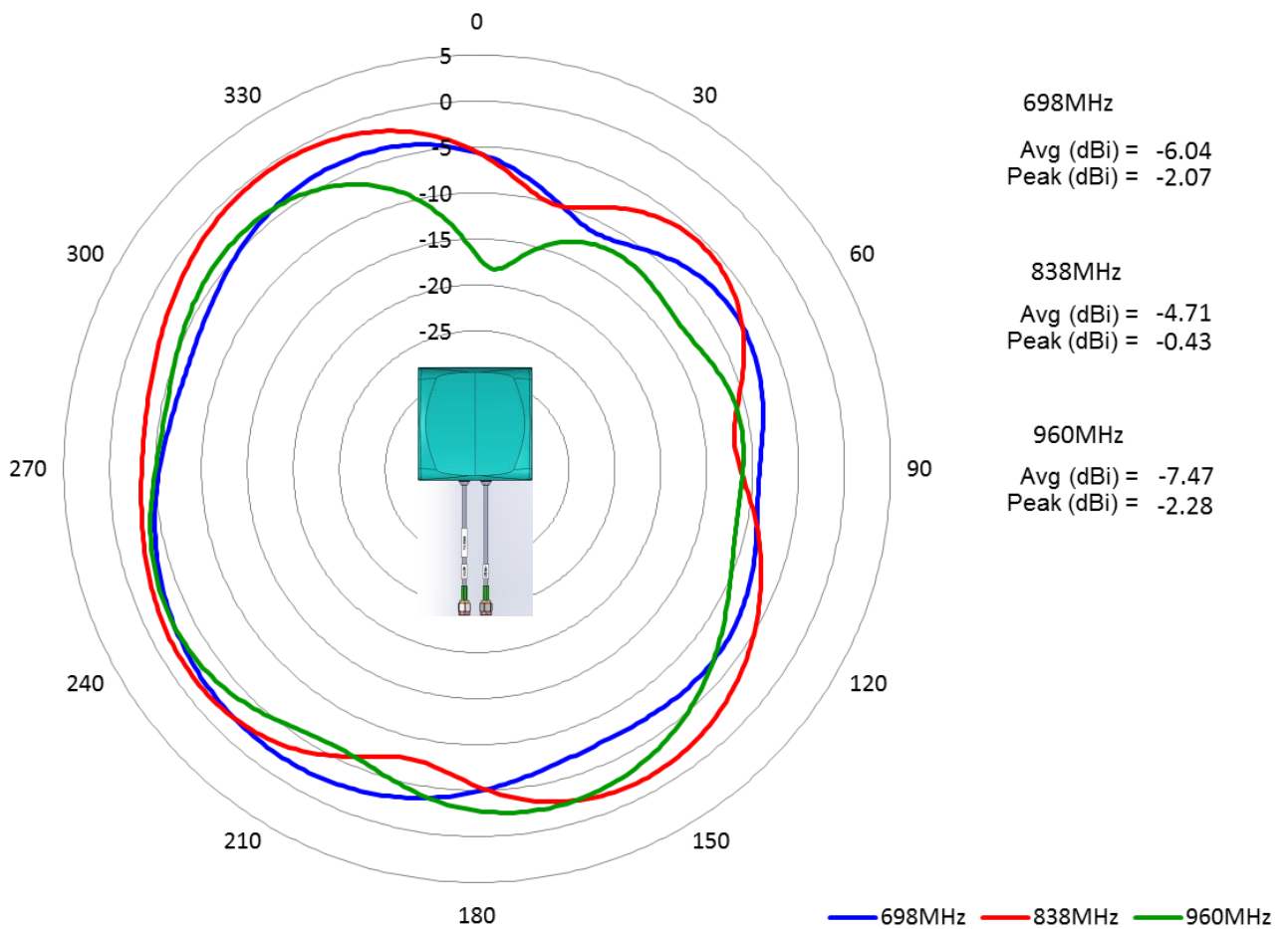

Note : Antenna measured in free space with 150mm cable

Issue: 1748P

In the effort to improve our products, we reserve the right to make changes judged to be necessary.

CONFIDENTIAL AND PROPRIETARY INFORMATION

This document contains confidential and proprietary information of Pulse Electronics, Inc. (Pulse) and is protected by copyright, trade secret and other state and federal laws. Its receipt or possession does not convey any rights to reproduce, disclose its contents, or to manufacture, use or sell anything it may describe. Reproduction, disclosure or use without specific written authorization of Pulse is strictly forbidden.

Preliminary



Description: 3G/4G LTE 2xMiMo Vehicular Antenna

Series: Jaguar

PART NUMBER: W1919

CHARTS

Gain Plots (Diversity LTE)

ZX Plane

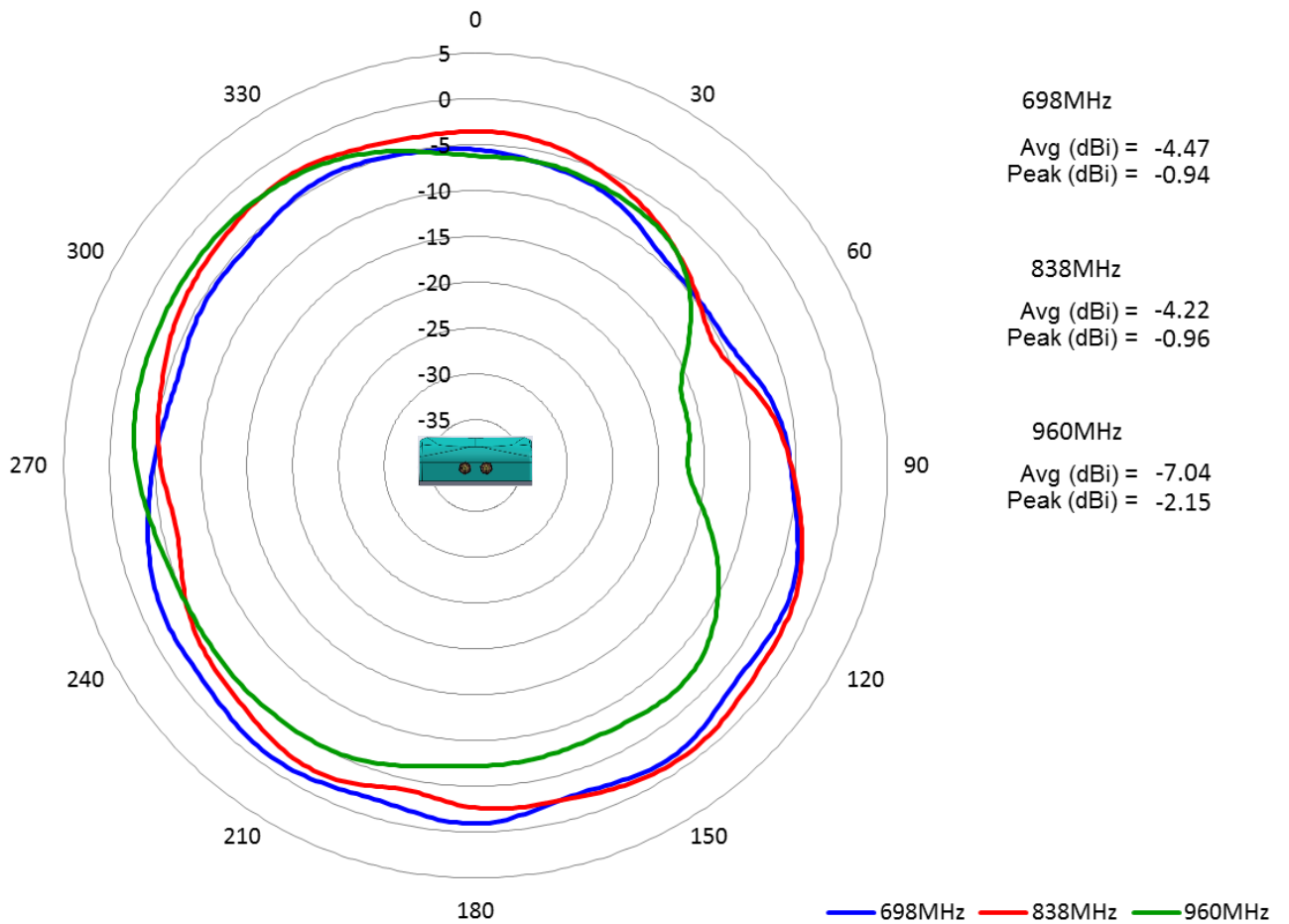

Note : Antenna measured in free space with 150mm cable

Issue: 1748P

In the effort to improve our products, we reserve the right to make changes judged to be necessary.
CONFIDENTIAL AND PROPRIETARY INFORMATION

This document contains confidential and proprietary information of Pulse Electronics, Inc. (Pulse) and is protected by copyright, trade secret and other state and federal laws. Its receipt or possession does not convey any rights to reproduce, disclose its contents, or to manufacture, use or sell anything it may describe. Reproduction, disclosure or use without specific written authorization of Pulse is strictly forbidden.

Preliminary



Description: 3G/4G LTE 2xMiMo Vehicular Antenna

Series: Jaguar

PART NUMBER: W1919

CHARTS

Gain Plots (Diversity LTE)

ZY Plane

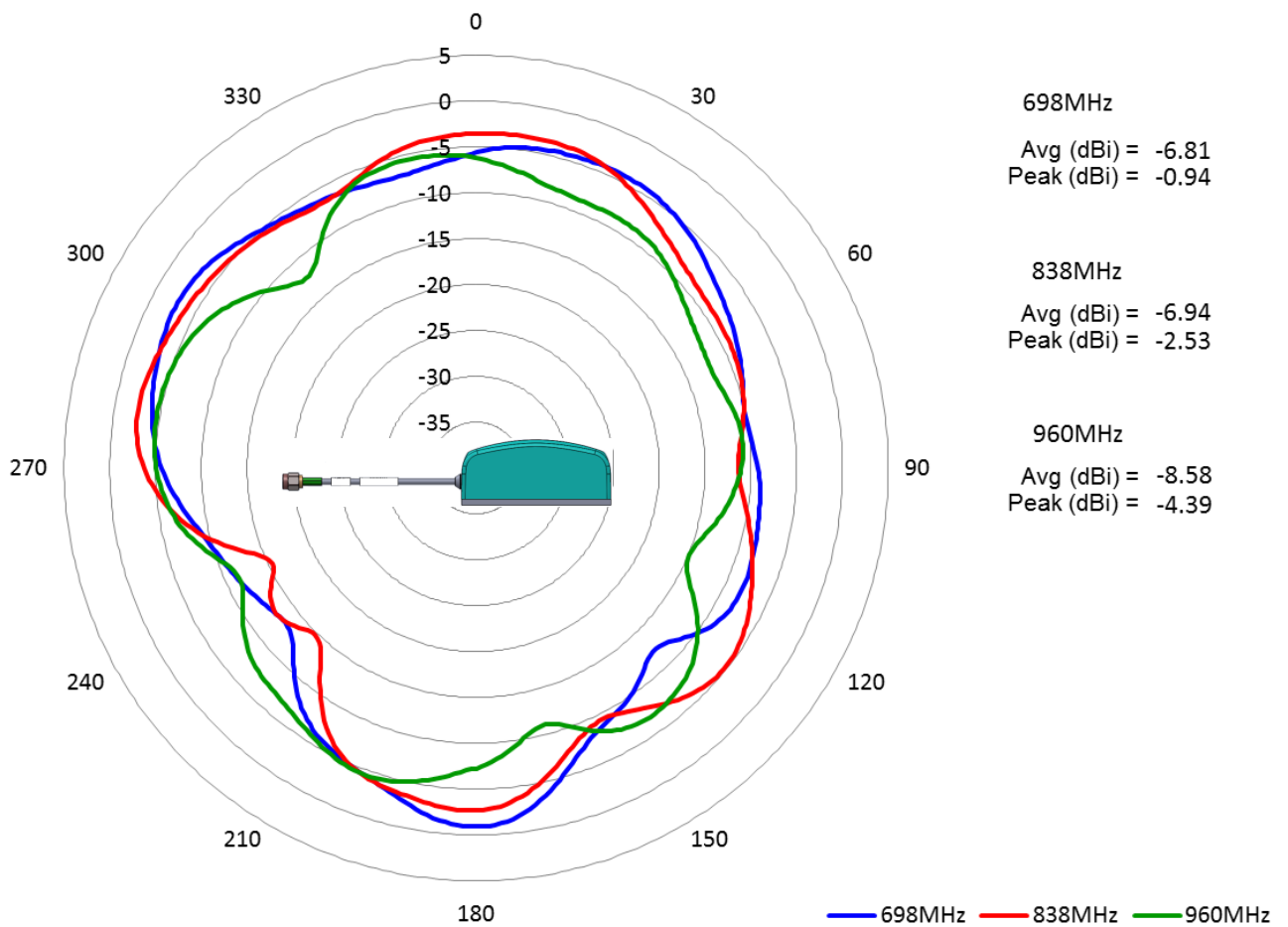

Note : Antenna measured in free space with 150mm cable

Issue: 1748P

In the effort to improve our products, we reserve the right to make changes judged to be necessary.
CONFIDENTIAL AND PROPRIETARY INFORMATION

This document contains confidential and proprietary information of Pulse Electronics, Inc. (Pulse) and is protected by copyright, trade secret and other state and federal laws. Its receipt or possession does not convey any rights to reproduce, disclose its contents, or to manufacture, use or sell anything it may describe. Reproduction, disclosure or use without specific written authorization of Pulse is strictly forbidden.

Preliminary



Description: 3G/4G LTE 2xMiMo Vehicular Antenna

Series: Jaguar

PART NUMBER: W1919

CHARTS

Gain Plots (Diversity LTE)

XY Plane

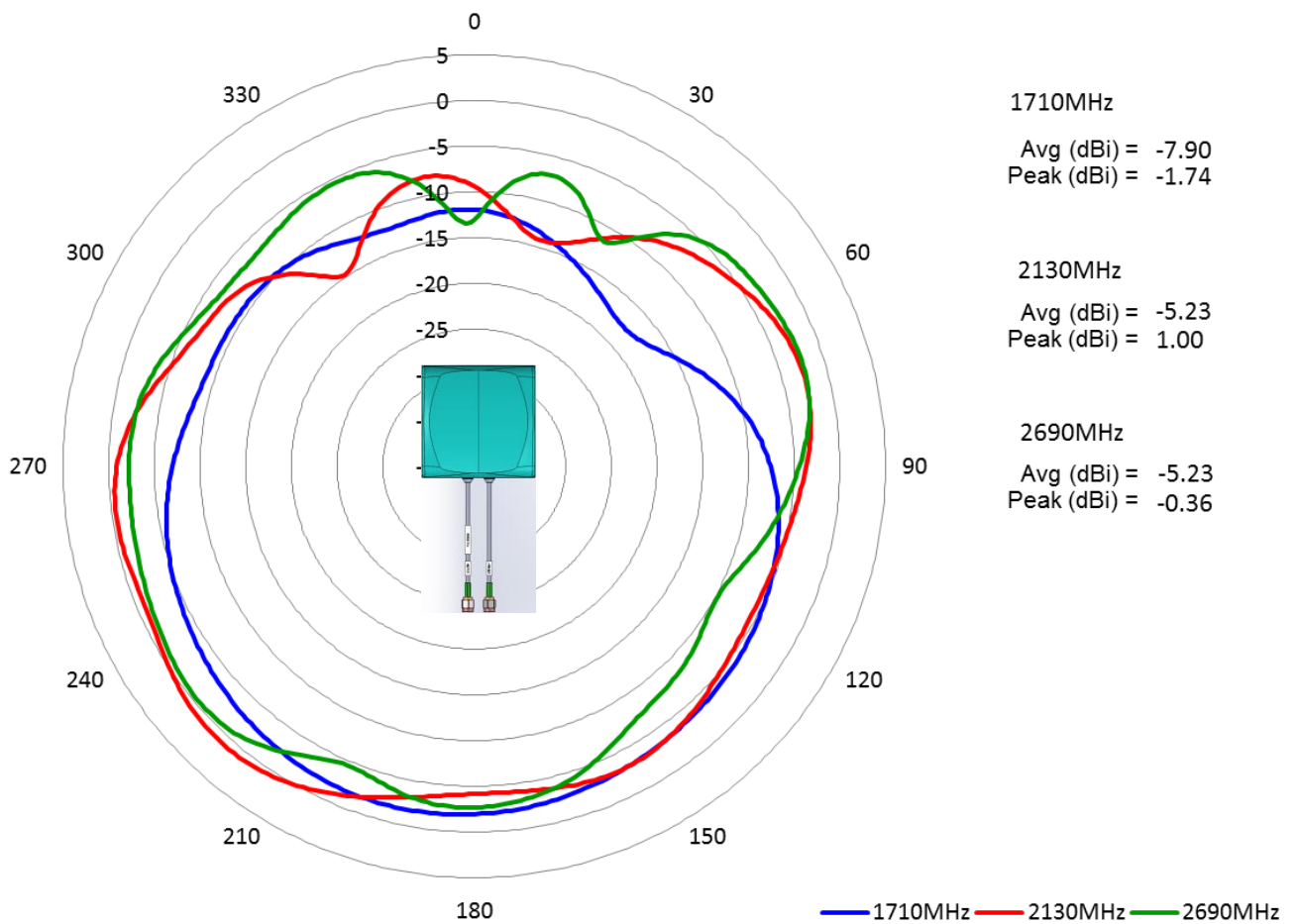

Note : Antenna measured in free space with 150mm cable

Issue: 1748P

In the effort to improve our products, we reserve the right to make changes judged to be necessary.
CONFIDENTIAL AND PROPRIETARY INFORMATION

This document contains confidential and proprietary information of Pulse Electronics, Inc. (Pulse) and is protected by copyright, trade secret and other state and federal laws. Its receipt or possession does not convey any rights to reproduce, disclose its contents, or to manufacture, use or sell anything it may describe. Reproduction, disclosure or use without specific written authorization of Pulse is strictly forbidden.

Preliminary



Description: 3G/4G LTE 2xMiMo Vehicular Antenna

Series: Jaguar

PART NUMBER: W1919

CHARTS

Gain Plots (Diversity LTE)

ZX Plane

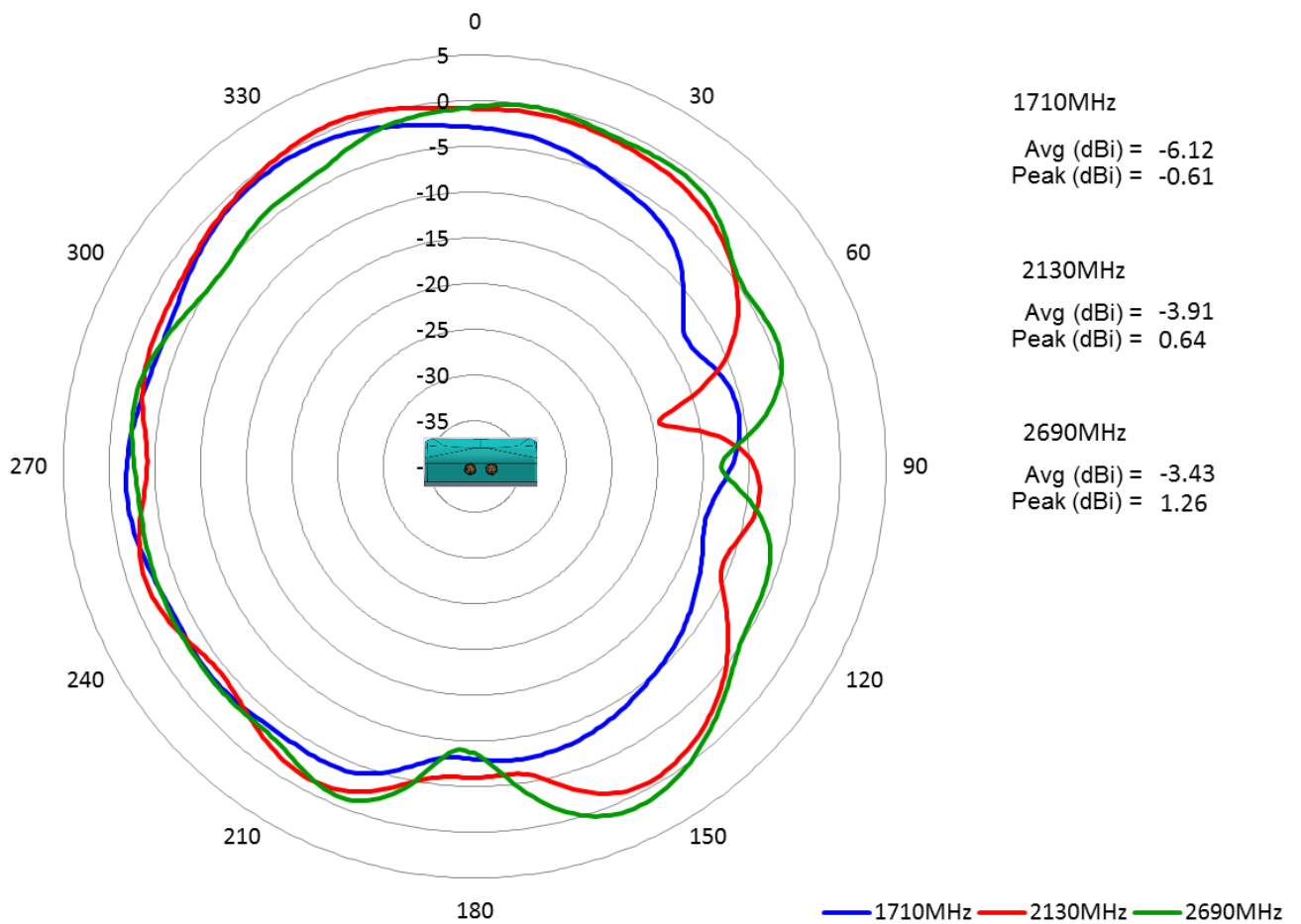

Note : Antenna measured in free space with 150mm cable

Issue: 1748P

In the effort to improve our products, we reserve the right to make changes judged to be necessary.
CONFIDENTIAL AND PROPRIETARY INFORMATION

This document contains confidential and proprietary information of Pulse Electronics, Inc. (Pulse) and is protected by copyright, trade secret and other state and federal laws. Its receipt or possession does not convey any rights to reproduce, disclose its contents, or to manufacture, use or sell anything it may describe. Reproduction, disclosure or use without specific written authorization of Pulse is strictly forbidden.

Preliminary



Description: 3G/4G LTE 2xMiMo Vehicular Antenna

Series: Jaguar

PART NUMBER: W1919

CHARTS

Gain Plots (Diversity LTE)

ZY Plane

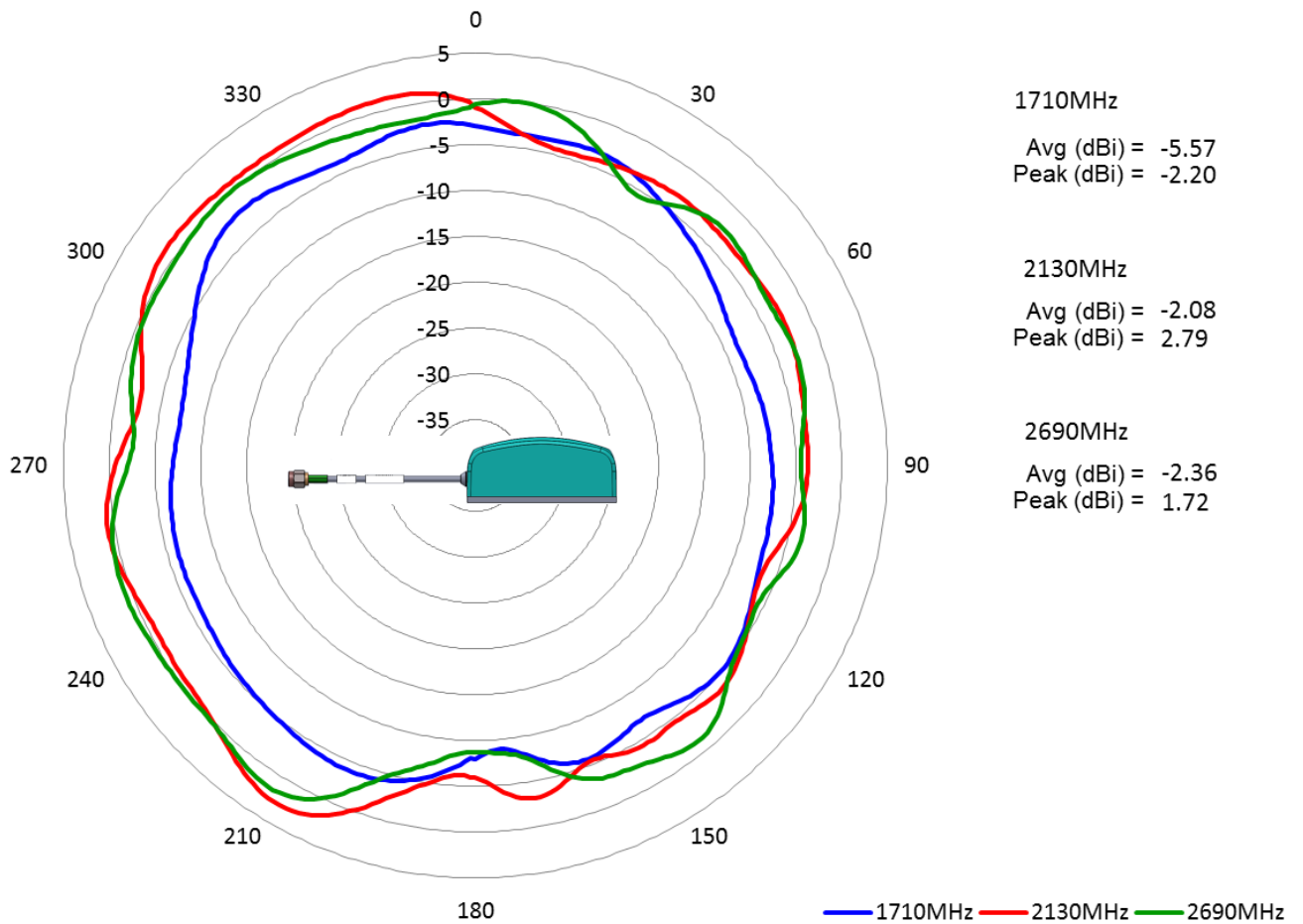

Note : Antenna measured in free space with 150mm cable

Issue: 1748P

In the effort to improve our products, we reserve the right to make changes judged to be necessary.
CONFIDENTIAL AND PROPRIETARY INFORMATION

This document contains confidential and proprietary information of Pulse Electronics, Inc. (Pulse) and is protected by copyright, trade secret and other state and federal laws. Its receipt or possession does not convey any rights to reproduce, disclose its contents, or to manufacture, use or sell anything it may describe. Reproduction, disclosure or use without specific written authorization of Pulse is strictly forbidden.

Preliminary



Description: 3G/4G LTE 2xMiMo Vehicular Antenna

Series: Jaguar

PART NUMBER: W1919

CHARTS

Gain Plots (Diversity LTE)

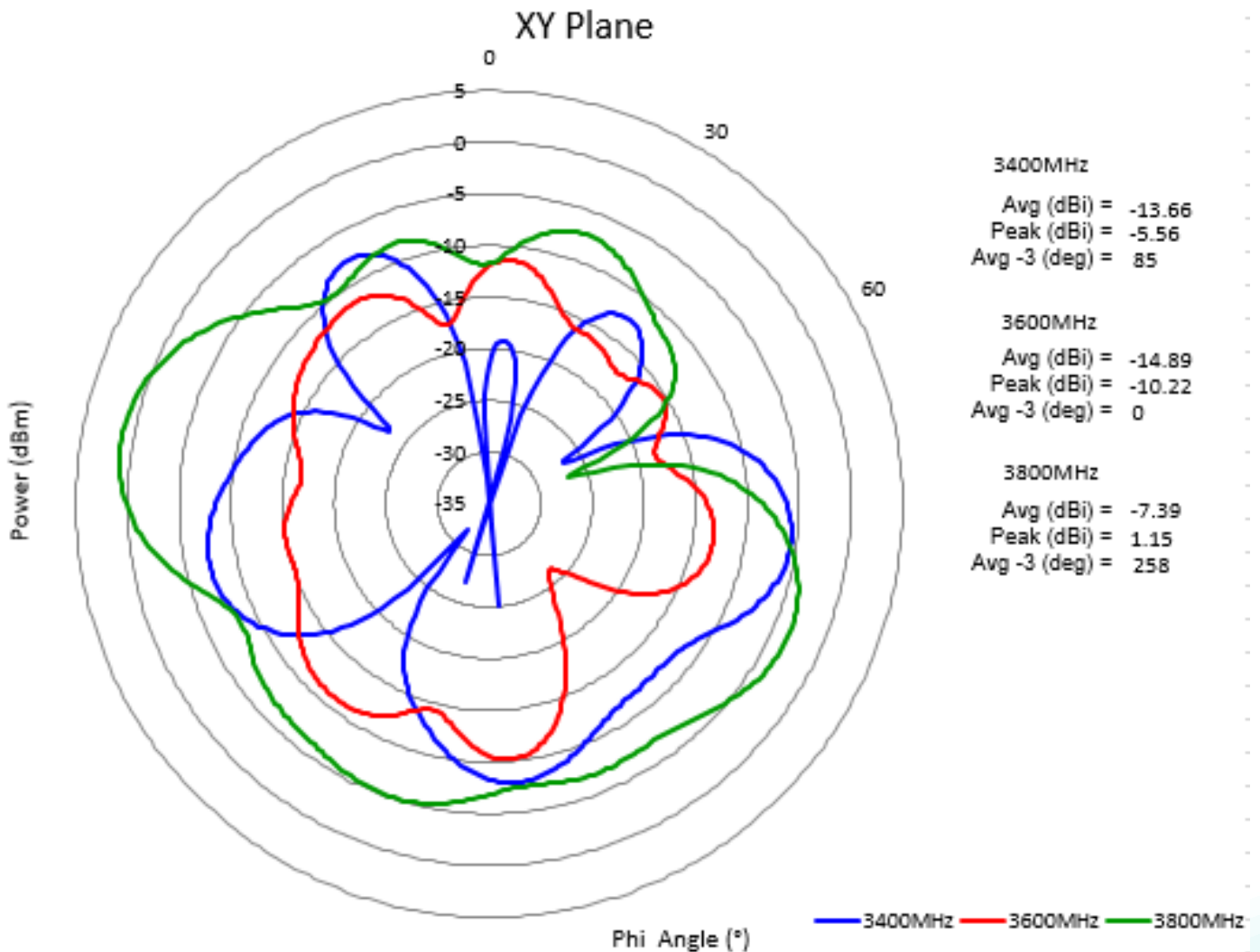

Note : Antenna measured in free space with 150mm cable

Issue: 1748P

In the effort to improve our products, we reserve the right to make changes judged to be necessary.
CONFIDENTIAL AND PROPRIETARY INFORMATION

This document contains confidential and proprietary information of Pulse Electronics, Inc. (Pulse) and is protected by copyright, trade secret and other state and federal laws. Its receipt or possession does not convey any rights to reproduce, disclose its contents, or to manufacture, use or sell anything it may describe. Reproduction, disclosure or use without specific written authorization of Pulse is strictly forbidden.

Preliminary

Description: 3G/4G LTE 2xMiMo Vehicular Antenna

Series: Jaguar

PART NUMBER: W1919

CHARTS

Gain Plots (Diversity LTE)

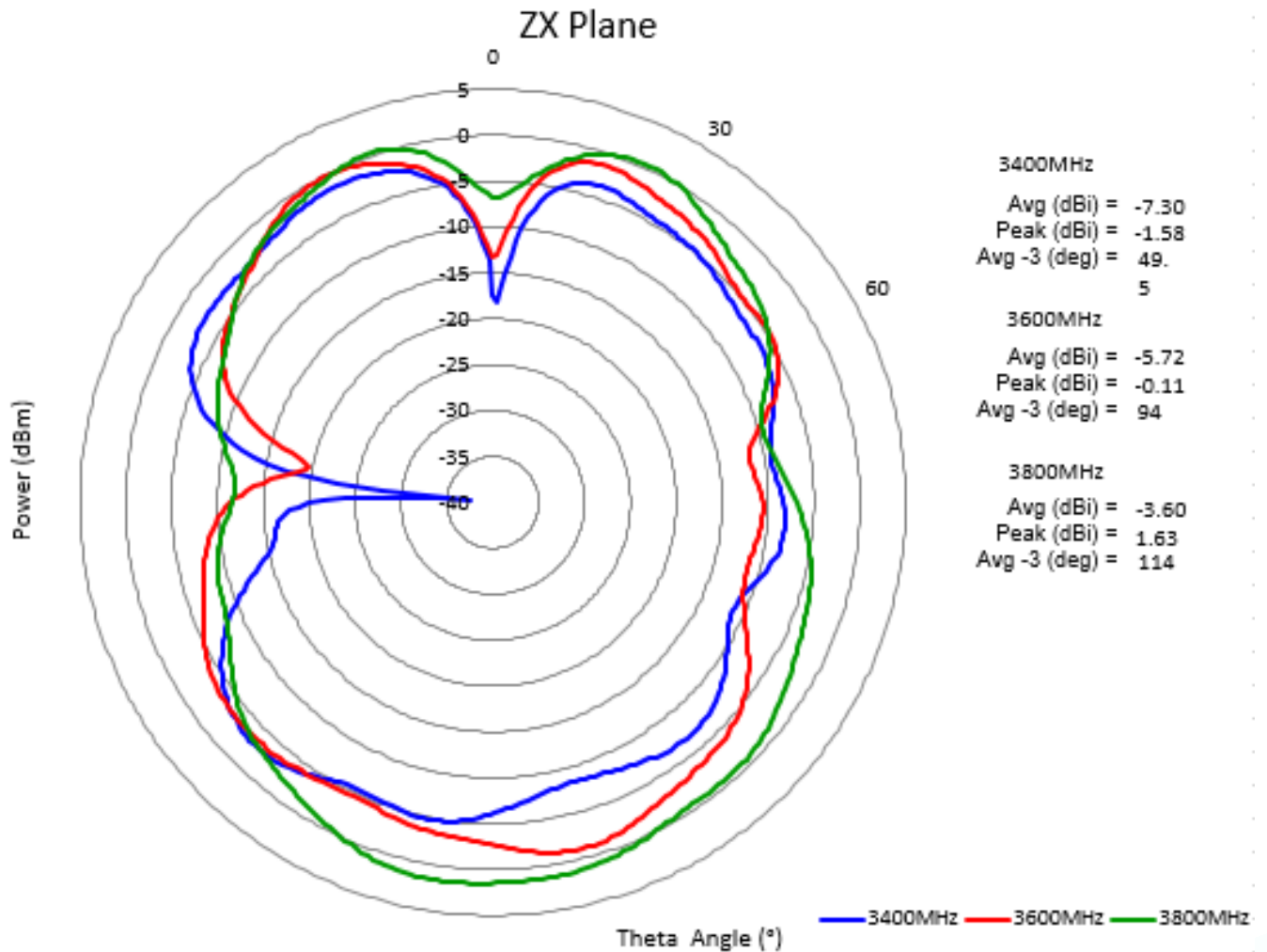

Note : Antenna measured in free space with 150mm cable

Issue: 1748P

In the effort to improve our products, we reserve the right to make changes judged to be necessary.
CONFIDENTIAL AND PROPRIETARY INFORMATION

This document contains confidential and proprietary information of Pulse Electronics, Inc. (Pulse) and is protected by copyright, trade secret and other state and federal laws. Its receipt or possession does not convey any rights to reproduce, disclose its contents, or to manufacture, use or sell anything it may describe. Reproduction, disclosure or use without specific written authorization of Pulse is strictly forbidden.

Preliminary

Description: 3G/4G LTE 2xMiMo Vehicular Antenna

Series: Jaguar

PART NUMBER: W1919

CHARTS

Gain Plots (Diversity LTE)

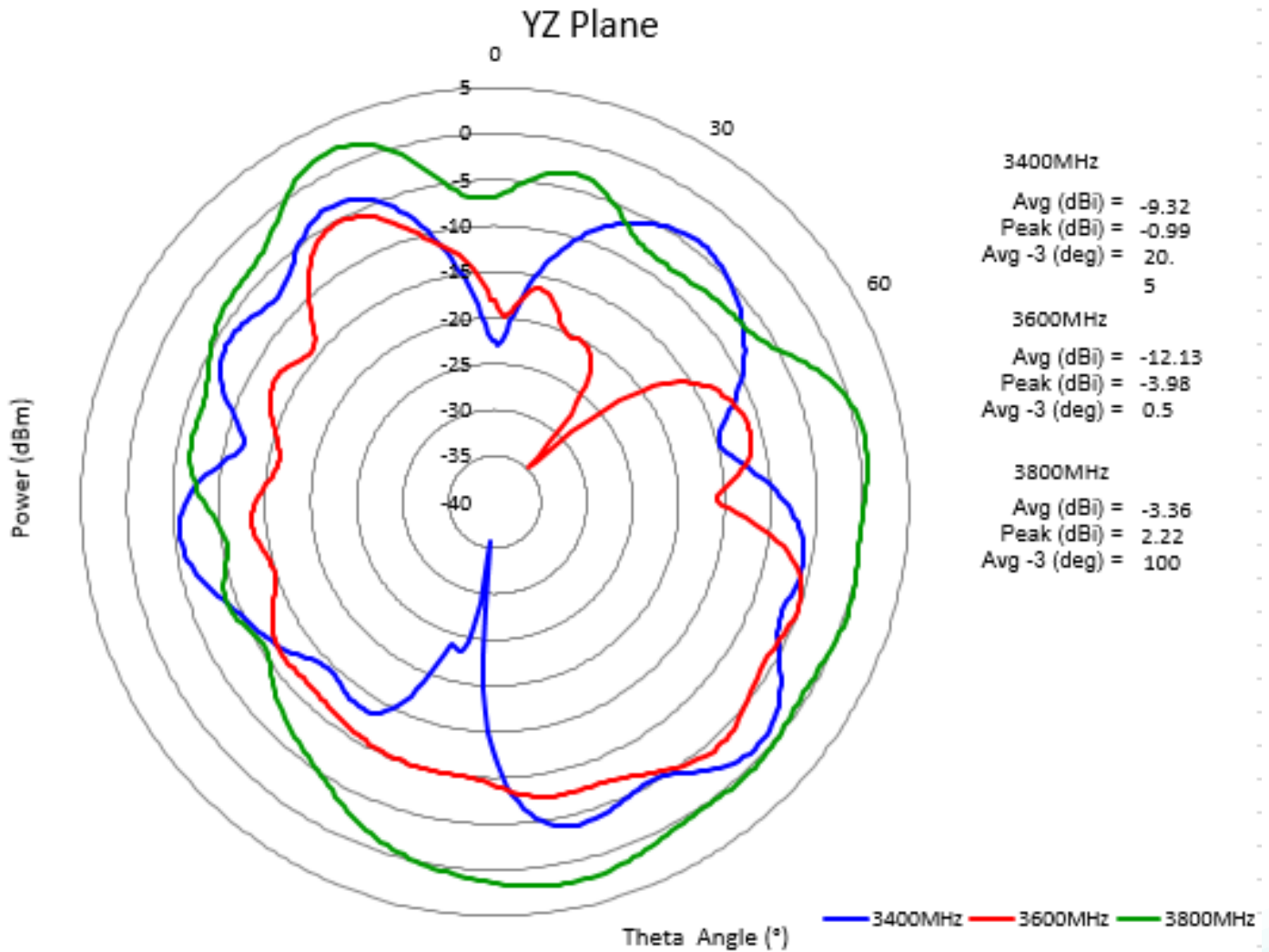

Note : Antenna measured in free space with 150mm cable

Issue: 1748P

In the effort to improve our products, we reserve the right to make changes judged to be necessary.
CONFIDENTIAL AND PROPRIETARY INFORMATION

This document contains confidential and proprietary information of Pulse Electronics, Inc. (Pulse) and is protected by copyright, trade secret and other state and federal laws. Its receipt or possession does not convey any rights to reproduce, disclose its contents, or to manufacture, use or sell anything it may describe. Reproduction, disclosure or use without specific written authorization of Pulse is strictly forbidden.

Preliminary

Series: Jaguar

Description: 3G/4G LTE 2xMiMo Vehicular Antenna

PART NUMBER: W1919

PACKAGING

1pcs antennas per foam bag

12pcs antennas per package box

Package box: 558mm*386mm*210mm

Issue: 1748P

In the effort to improve our products, we reserve the right to make changes judged to be necessary.

CONFIDENTIAL AND PROPRIETARY INFORMATION

This document contains confidential and proprietary information of Pulse Electronics, Inc. (Pulse) and is protected by copyright, trade secret and other state and federal laws. Its receipt or possession does not convey any rights to reproduce, disclose its contents, or to manufacture, use or sell anything it may describe. Reproduction, disclosure or use without specific written authorization of Pulse is strictly forbidden.

Preliminary



Данный компонент на территории Российской Федерации

Вы можете приобрести в компании MosChip.

Для оперативного оформления запроса Вам необходимо перейти по данной ссылке:

<http://moschip.ru/get-element>

Вы можете разместить у нас заказ для любого Вашего проекта, будь то серийное производство или разработка единичного прибора.

В нашем ассортименте представлены ведущие мировые производители активных и пассивных электронных компонентов.

Нашей специализацией является поставка электронной компонентной базы двойного назначения, продукции таких производителей как XILINX, Intel (ex.ALTERA), Vicor, Microchip, Texas Instruments, Analog Devices, Mini-Circuits, Amphenol, Glenair.

Сотрудничество с глобальными дистрибьюторами электронных компонентов, предоставляет возможность заказывать и получать с международных складов практически любой перечень компонентов в оптимальные для Вас сроки.

На всех этапах разработки и производства наши партнеры могут получить квалифицированную поддержку опытных инженеров.

Система менеджмента качества компании отвечает требованиям в соответствии с ГОСТ Р ИСО 9001, ГОСТ РВ 0015-002 и ЭС РД 009

Офис по работе с юридическими лицами:

105318, г.Москва, ул.Щербаковская д.3, офис 1107, 1118, ДЦ «Щербаковский»

Телефон: +7 495 668-12-70 (многоканальный)

Факс: +7 495 668-12-70 (доб.304)

E-mail: info@moschip.ru

Skype отдела продаж:

moschip.ru

moschip.ru_4

moschip.ru_6

moschip.ru_9