

PLC-OPIT-230UC/ 48DC/100/SEN

Order No.: 2900361



<http://eshop.phoenixcontact.de/phoenix/treeViewClick.do?UID=2900361>

PLC sensor interface, consisting of PLC-BPIT...SEN basic terminal block with Push-In connection and pluggable miniature optocoupler, for assembly on DIN rail NS 35/7.5, input: 230 V AC/ 220 V DC, output: 3-48 V DC/100 mA



Commercial data	
GTIN (EAN)	4 046356 508803 
Note	Made-to-order
sales group	G246
Pack	10 pcs.
Customs tariff	85364190
Catalog page information	Page 91 (IF-2011)

Product notes

WEEE/RoHS-compliant since:
04/08/2009



<http://www.download.phoenixcontact.com>
Please note that the data given here has been taken from the online catalog. For comprehensive information and data, please refer to the user documentation. The General Terms and Conditions of Use apply to Internet downloads.

Technical data

Input data	
Nominal input voltage U_N	230 V AC (220 V DC)
	220 V DC
Input voltage range in reference to U_N	0.8 ... 1.1

Switching threshold "0" signal in reference to U_N	≤ 0.3
Switching threshold "1" signal in reference to U_N	≥ 0.8
Typical input current at U_N	3.5 mA
Typical response time	3 ms (at U_N)
Typical turn-off time	5 ms (at U_N)
Operating voltage display	Yellow LED
Type of protection	Bridge rectifier
Protective circuit/component	Bridge rectifier
Transmission frequency	10 Hz

Output data

Output nominal voltage range	3 V DC ... 48 V DC
Limiting continuous current	100 mA
Voltage drop at max. limiting continuous current	≤ 1 V
Output circuit	2-wire, floating
Type of protection	Protection against polarity reversal
	Surge protection
Protective circuit/component	Polarity protection diode

Connection data

Connection method	Push-In connection
Stripping length	8 mm
Conductor cross section solid min.	0.14 mm ²
Conductor cross section solid max.	2.5 mm ²
Conductor cross section stranded min.	0.14 mm ²
Conductor cross section stranded max.	2.5 mm ²
Conductor cross section AWG/kcmil min.	26
Conductor cross section AWG/kcmil max	14

General data

Width	6.2 mm
Height	80 mm
Depth	94 mm
Ambient temperature (operation)	-25 °C ... 60 °C
Ambient temperature (storage/transport)	-25 °C ... 70 °C
Mounting position	Any
Assembly instructions	In rows with zero spacing

Operating mode	100% operating factor
Inflammability class acc. to UL 94	V0
Pollution degree	2
Surge voltage category	III

Certificates / Approvals



Certification CUL, CUL Listed, UL, UL Listed

Accessories

Item	Designation	Description
Assembly		
0801762	NS 35/ 7,5 CU UNPERF 2000MM	DIN rail, material: Copper, unperforated, height 7.5 mm, width 35 mm, length: 2 m
0801733	NS 35/ 7,5 PERF 2000MM	DIN rail, material: steel galvanized and passivated with a thick layer, perforated, height 7.5 mm, width 35 mm, length: 2000 mm
0801681	NS 35/ 7,5 UNPERF 2000MM	DIN rail, material: Steel, unperforated, height 7.5 mm, width 35 mm, length: 2 m
0801377	NS 35/ 7,5 V2A UNPERF 2000MM	DIN rail, Width: 35 mm, Height: 7.5 mm, Length: 2000 mm, Color: silver
1201756	NS 35/15 AL UNPERF 2000MM	DIN rail, deep drawn, high profile, unperforated, 1.5 mm thick, material: aluminum, height 15 mm, width 35 mm, length 2000 mm
1201895	NS 35/15 CU UNPERF 2000MM	DIN rail, material: Copper, unperforated, 1.5 mm thick, height 15 mm, width 35 mm, length: 2 m
1201730	NS 35/15 PERF 2000MM	DIN rail, material: steel galvanized and passivated with a thick layer, perforated, height 15 mm, width 35 mm, length: 2000 mm
1201714	NS 35/15 UNPERF 2000MM	DIN rail, material: Steel, unperforated, height 15 mm, width 35 mm, length: 2 m
1201798	NS 35/15-2,3 UNPERF 2000MM	DIN rail, material: Steel, unperforated, 2.3 mm thick, height 15 mm, width 35 mm, length: 2 m
2966841	PLC-ATP BK	Separating plate, 2 mm thick, required at the start and end of a PLC terminal strip. Furthermore, it is used for: visual separation of groups, safe isolation of different voltages of neighboring PLC relays in acc. with DIN VDE 0106-101, isolation

Bridges

2966812	FBST 6-PLC BU	Single plug-in bridge, Length: 6 mm, Number of positions: 2, Color: blue
2966825	FBST 6-PLC GY	Single plug-in bridge, Length: 6 mm, Number of positions: 2, Color: gray
2966236	FBST 6-PLC RD	Single plug-in bridge, Length: 6 mm, Number of positions: 2, Color: red
2967688	FBST 8-PLC GY	Single plug-in bridge, Length: 8 mm, Number of positions: 2, Color: gray
2966692	FBST 500-PLC BU	Continuous plug-in bridge, Length: 500 mm, Color: blue
2966838	FBST 500-PLC GY	Continuous plug-in bridge, Length: 500 mm, Color: gray
2966786	FBST 500-PLC RD	Continuous plug-in bridge, Length: 500 mm, Color: red

General

2966621	OPT-60DC/ 48DC/100	Pluggable miniature optocouplers, input optocouplers, input: 60 V DC, output: 3 - 48 V DC/ 100 mA
2900452	PLC-BPIT-230UC/ 1/SEN	6.2 mm PLC sensor basic terminal blocks with Push-In connection method, input voltage of 230 V AC (without relay or optocoupler)
2966508	PLC-ESK GY	Power terminal block, for the input of up to four potentials, for mounting on NS 35/7.5
2296087	PLC-V8/D15B/IN	V8-INPUT adapter for eight 6.2 mm PLC interfaces (1 PDT, etc./ see "Additional Products"). 15-pin D-SUB female connector, control logic: Positive switching
2296074	PLC-V8/D15S/IN	V8-INPUT adapter for eight 6.2 mm PLC interfaces (1 PDT, etc./ see "Additional Products"). 15-pin D-SUB male connector, control logic: Positive switching
2296553	PLC-V8/FLK14/IN	V8L-INPUT adapter for eight 6.2 mm PLC interfaces (1 PDT, etc./see "Supplementary Products"). 14-pos. flat-ribbon cable connection for the PLC system cabling, control logic: Plus switching
2304115	PLC-V8/FLK14/IN/M	V8L-INPUT adapter for eight 6.2 mm PLC interfaces (1 PDT, etc./see "Supplementary Products"). 14-pos. flat-ribbon cable connection for the PLC system cabling, control logic: Minus switching

Marking

1053001	ZB 10:UNBEDRUCKT	Zack strip, unprinted: 10-section, for individual labeling with M-PEN, ZB-T or CMS system, sufficient for 100 terminal blocks, for a terminal width of 10.2 mm, color: White
1053014	ZB10,LGS:FORTL.ZAHLEN	Zack strip, 10-section, printed horizontally: with the numbers, 1-10, 11-20 etc. up to 991-1000, color: white
5060883	ZB10/WH-100:UNBEDRUCKT	Zack strip, unprinted: 10-section, for individual labeling with M-PEN, ZB-T or CMS system, large batch, sufficient for labeling 1000 terminal blocks, for a terminal width of 10.2 mm, color: White

Tools

1204517	SZF 1-0,6X3,5	Actuation tool, for ST terminal blocks, also suitable for use as a bladed screwdriver, size: 0.6 x 3.5 x 100 mm, 2-component grip, with non-slip grip
---------	---------------	---

Diagrams/Drawings

Circuit diagram

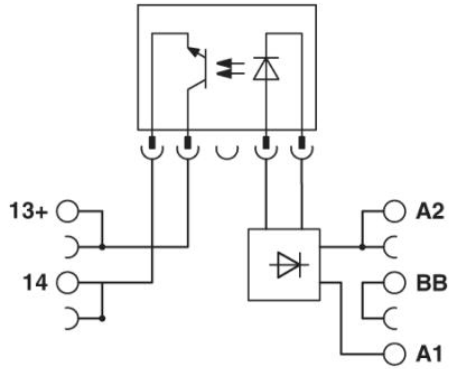

Address

PHOENIX CONTACT Inc., USA
586 Fulling Mill Road
Middletown, PA 17057, USA
Phone (800) 888-7388
Fax (717) 944-1625
<http://www.phoenixcon.com>



© 2011 Phoenix Contact
Technical modifications reserved;

Данный компонент на территории Российской Федерации

Вы можете приобрести в компании MosChip.

Для оперативного оформления запроса Вам необходимо перейти по данной ссылке:

<http://moschip.ru/get-element>

Вы можете разместить у нас заказ для любого Вашего проекта, будь то серийное производство или разработка единичного прибора.

В нашем ассортименте представлены ведущие мировые производители активных и пассивных электронных компонентов.

Нашей специализацией является поставка электронной компонентной базы двойного назначения, продукции таких производителей как XILINX, Intel (ex.ALTERA), Vicor, Microchip, Texas Instruments, Analog Devices, Mini-Circuits, Amphenol, Glenair.

Сотрудничество с глобальными дистрибьюторами электронных компонентов, предоставляет возможность заказывать и получать с международных складов практически любой перечень компонентов в оптимальные для Вас сроки.

На всех этапах разработки и производства наши партнеры могут получить квалифицированную поддержку опытных инженеров.

Система менеджмента качества компании отвечает требованиям в соответствии с ГОСТ Р ИСО 9001, ГОСТ РВ 0015-002 и ЭС РД 009

Офис по работе с юридическими лицами:

105318, г.Москва, ул.Щербаковская д.3, офис 1107, 1118, ДЦ «Щербаковский»

Телефон: +7 495 668-12-70 (многоканальный)

Факс: +7 495 668-12-70 (доб.304)

E-mail: info@moschip.ru

Skype отдела продаж:

moschip.ru

moschip.ru_4

moschip.ru_6

moschip.ru_9