



Main

Range of product	Modicon TM5
Product or component type	Power distribution module with internal fuse
Product specific application	Supply 24 V DC I/O modules and bus TM5

Complementary

Range compatibility	Modicon LMC058 Modicon M258
Product compatibility	Motion controller Logic controller
[Us] rated supply voltage	24 V
Network type	DC
Power supply output current	6.3 A for I/O power segment 1136 mA for TM5 power bus 14...131 °F (-10...55 °C) 740 mA for TM5 power bus 131...140 °F (55...60 °C)
Power dissipation in W	<= 2.13 W
Color	Grey
Short-circuit protection	6.3 A with internal fuse
Current consumption	<= 34 mA 24 V DC
Marking	CE
Product weight	0.07 lb(US) (0.03 kg)

Environment

standards	CSA C22.2 No 142 IEC 61131-2 UL 508 CSA C22.2 No 213
product certifications	CSA C-Tick CULus GOST-R
ambient air temperature for operation	14...122 °F (-10...50 °C) vertical installation 14...131 °F (-10...55 °C) without derating factor horizontal installation 131...140 °F (55...60 °C) with derating factor horizontal installation
ambient air temperature for storage	-13...158 °F (-25...70 °C)
relative humidity	5...95 % without condensation
operating altitude	0...6561.68 ft (0...2000 m)
storage altitude	0...9842.52 ft (0...3000 m)
vibration resistance	1 gn 8.4...150 Hz DIN rail 3.5 mm 5...8.4 Hz DIN rail
shock resistance	15 gn 11 ms
resistance to electrostatic discharge	4 kV on contact conforming to EN/IEC 61000-4-2 8 kV in air conforming to EN/IEC 61000-4-2
resistance to electromagnetic fields	0.91 V/yd (1 V/m) 2...2.7 GHz conforming to EN/IEC 61000-4-3 9.14 V/yd (10 V/m) 80...2000 MHz conforming to EN/IEC 61000-4-3
resistance to fast transients	1 kV I/O conforming to EN/IEC 61000-4-4

The information provided in this documentation contains general descriptions and/or technical characteristics of the performance of the products contained herein. This documentation is not intended as a substitute for and is not to be used for determining suitability or reliability of these products for specific user applications. It is the duty of any such user or integrator to perform the appropriate and complete risk analysis, evaluation and testing of the products with respect to the relevant specific application or use thereof. Neither Schneider Electric Industries SAS nor any of its affiliates or subsidiaries shall be responsible or liable for misuse of the information contained herein.

	1 kV shielded cable conforming to EN/IEC 61000-4-4 2 kV power lines conforming to EN/IEC 61000-4-4
surge withstand	0.5 kV differential mode conforming to EN/IEC 61000-4-5 1 kV common mode conforming to EN/IEC 61000-4-5
electromagnetic compatibility	EN/IEC 61000-4-6
disturbance radiated/conducted	CISPR 11

Offer Sustainability

Green Premium product	Green Premium product
Compliant - since 1039 - Schneider Electric declaration of conformity	Compliant - since 1039 - Schneider Electric declaration of conformity
Reference not containing SVHC above the threshold	Reference not containing SVHC above the threshold
Available	Available
Available	Available
WARNING: This product can expose you to chemicals including:	WARNING: This product can expose you to chemicals including:
Lead and lead compounds, which is known to the State of California to cause cancer and birth defects or other reproductive harm.	Lead and lead compounds, which is known to the State of California to cause cancer and birth defects or other reproductive harm.
For more information go to www.p65warnings.ca.gov	For more information go to www.p65warnings.ca.gov

Contractual warranty

Warranty period	18 months
-----------------	-----------

TM5 Slice

Dimensions

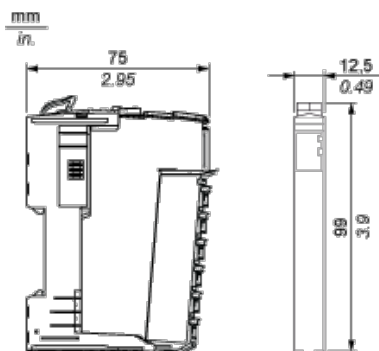

TM5 System

Spacing Requirements

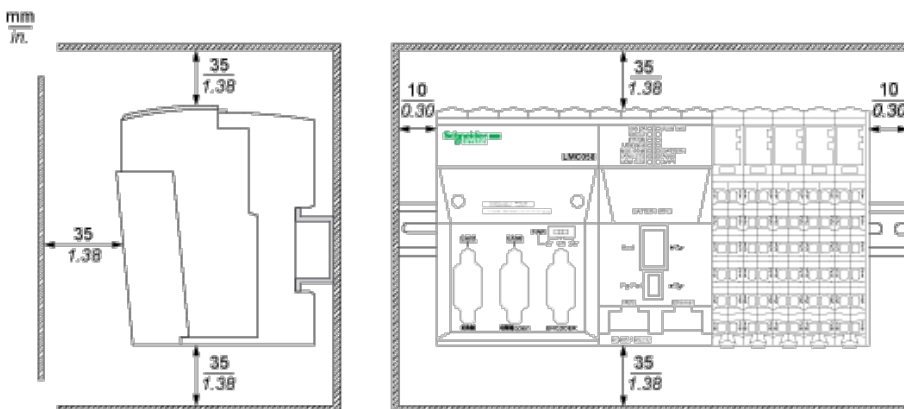



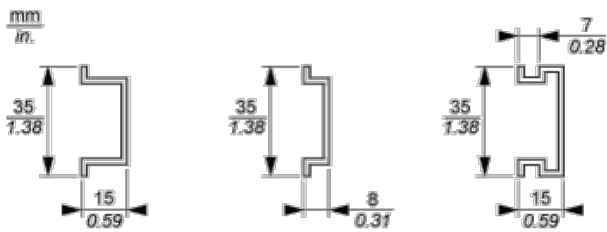

Mounting on a DIN Rail



TM5 System Wiring Recommendations

Wire Sizes to Use with the Removable Spring Terminal Blocks

mm in.					
mm ²	0,08...2,5	0,25...2,5	0,25...1,5	2 x 0,25...2 x 0,75	
AWG	28...14	24...14	24...16	2 x 24...2 x 18	

PDM Electronic Module 24 Vdc I/O Fuse 6.3 A and TM5 Power Bus

Wiring Diagram

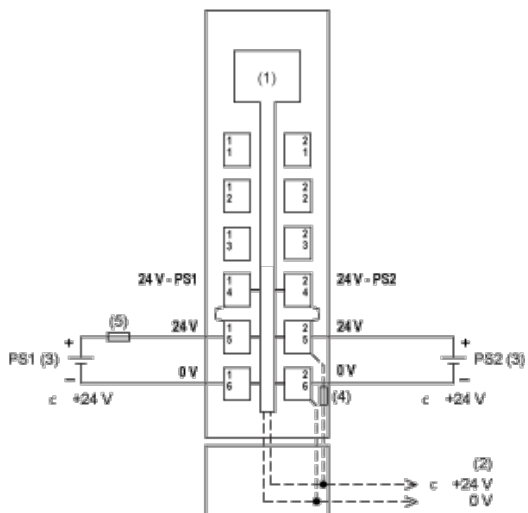

- (1) Internal electronics
- (2) 24 Vdc I/O power segment integrated into the bus bases
- (3) PS1/PS2: External isolated SELV power supplies limited to 200 VA for UL508 conformance, or limited to 150 VA for CSA 22.2, N° 142 conformance
- (4) Integrated fuse type T slow-blow 10 A 250 V exchangeable
- (5) External fuse type T slow-blow 1 A 250 V

Данный компонент на территории Российской Федерации

Вы можете приобрести в компании MosChip.

Для оперативного оформления запроса Вам необходимо перейти по данной ссылке:

<http://moschip.ru/get-element>

Вы можете разместить у нас заказ для любого Вашего проекта, будь то серийное производство или разработка единичного прибора.

В нашем ассортименте представлены ведущие мировые производители активных и пассивных электронных компонентов.

Нашей специализацией является поставка электронной компонентной базы двойного назначения, продукции таких производителей как XILINX, Intel (ex.ALTERA), Vicor, Microchip, Texas Instruments, Analog Devices, Mini-Circuits, Amphenol, Glenair.

Сотрудничество с глобальными дистрибьюторами электронных компонентов, предоставляет возможность заказывать и получать с международных складов практически любой перечень компонентов в оптимальные для Вас сроки.

На всех этапах разработки и производства наши партнеры могут получить квалифицированную поддержку опытных инженеров.

Система менеджмента качества компании отвечает требованиям в соответствии с ГОСТ Р ИСО 9001, ГОСТ РВ 0015-002 и ЭС РД 009

Офис по работе с юридическими лицами:

105318, г.Москва, ул.Щербаковская д.3, офис 1107, 1118, ДЦ «Щербаковский»

Телефон: +7 495 668-12-70 (многоканальный)

Факс: +7 495 668-12-70 (доб.304)

E-mail: info@moschip.ru

Skype отдела продаж:

moschip.ru

moschip.ru_4

moschip.ru_6

moschip.ru_9