

# 3M™ I/O Connector Mounting Options and Hardware

## Hardware Guide

Date Modified: April 24, 2012

Mounting Hardware Applications - Table 1

Part Number	Type	Mini D Ribbon (MDR) Conn.'s	D Sub Conn.'s	D Ribbon Conn.'s	Shrunk D Ribbon (SDR) Conn.'s	Sheet #	RIA Code
3341-1L <sup>2</sup>	Jack Socket Screw		X	X		2 of 9	RIA E5 & C3 apply
3341-1S <sup>2</sup>	Jack Socket Screw		X	X			
3341-2	Jack Socket Screw			X			
3341-3	Jack Socket Screw			X			
3341-4 <sup>2</sup>	Jack Socket Screw		X	X			
3341-10	Jack Socket Screw	X				3 of 9	
3341-13	Jack Socket Screw	X					
3341-16	Jack Socket Screw	X					
3341-17	Jack Socket Screw	X					
3341-25	Jack Socket Screw	X					
3341-30	Jack Socket Screw	X				4 of 9	
3341-31	Jack Socket Screw	X					
3341-32	Jack Socket Screw	X					
3341-35	Jack Socket Screw	X					
3341-36	Jack Socket Screw	X					
3342-1 <sup>2</sup>	Jack Screw Kits		X			5 of 9	
3342-2 <sup>2</sup>	Jack Screw Kits		X				
3342-3 <sup>2</sup>	Jack Screw Kits		X	X			
3342-4 <sup>2</sup>	Jack Screw Kits		X	X			
3344-3	Board Lock Screw	X				6 of 9	
3344-4	Board Lock Screw	X					
3344-26	Panel Mount Screw	X					
3344-38	Panel Mount Screw	X					
3344-44	Panel Mount Screw	X					
3344-45	Panel Mount Screw	X				7 of 9	
3475-1	Bail Mount Kits			X			
3475-4	Bail Mount Kits			X			
3475-5	Bail Mount Kits			X		8 of 9	
12600-S-08	Jack Socket Screw				X		
12600-S-10	Jack Socket Screw				X		
12600-S-12	Jack Socket Screw				X		
3344-46	Board Lock Screw				X	9 of 9	
Mounting hardware Guide			X				

-See sheet 7 of 9 for D Ribbon & Plastic Connector accessories.-

Notes:

1. Use Table 1 as a guide for selecting the correct mounting hardware.
2. See sheet 9 of 9 for selection guide - 9 to 37 and 50 position D Sub connectors.
3. See Regulatory Information Appendix (RIA) for chemical compliance information.

TS-0142-J  
Sheet 1 of 9

# 3M™ I/O Connector Mounting Options and Hardware

## Jack Socket Screws

### 3M Part Number 3341-1L

Kit Contents:  
2 - Jack Sockets  
4 - Spacers .031 [0.79] Thick  
2 - Lock Washers  
2 - 4-40 Nuts

Material: Steel  
Finish: Zinc with Clear Chromate  
Screw / Socket Thread Size: #4-40 / #4-40  
Recommended Max. Torque: 7.0 inch-lbf [0.8 N-m]

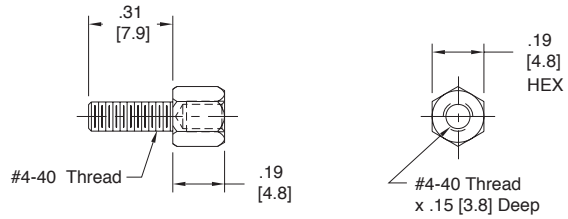

### 3M Part Number 3341-1S

Kit Contents:  
2 - Jack Sockets  
8 - Spacers .031 [0.79] Thick  
2 - Lock Washers  
2 - 4-40 Nuts

Material: Steel  
Finish: Zinc with Clear Chromate  
Screw / Socket Thread Size: #4-40 / #4-40  
Recommended Max. Torque: 7.0 inch-lbf [0.8 N-m]

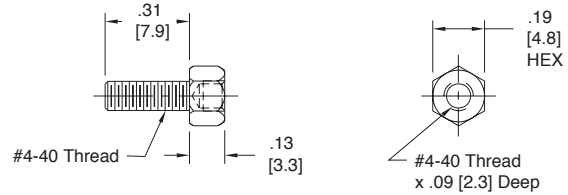

### 3M Part Number 3341-2

Kit Contents:  
2 - Jack Sockets  
2 - Lock Washers  
2 - 4-40 Nuts

Material: Steel  
Finish: Zinc with Clear Chromate  
Screw / Socket Thread Size: #4-40 / #4-40  
Recommended Max. Torque: 7.0 inch-lbf [0.8 N-m]

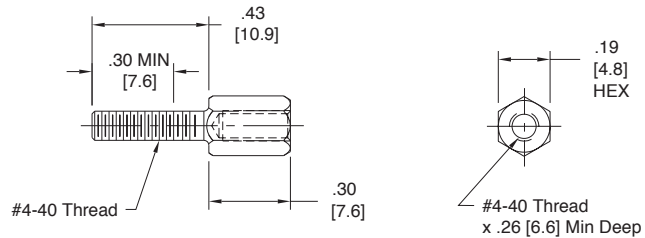

### 3M Part Number 3341-3 IEEE-488-Type

Kit Contents:  
2 - Jack Sockets  
4 - Spacers .031 [0.79] Thick  
2 - Lock Washers  
2 - 4-40 Nuts

Material: Steel  
Finish: Black Oxide  
Screw / Socket Thread Size: #4-40 / M3.5  
Recommended Max. Torque: 7.0 inch-lbf [0.8 N-m]

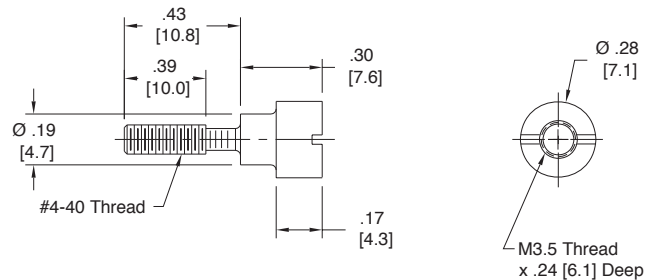

### 3M Part Number 3341-4

Kit Contents:  
2 - Jack Sockets  
4 - Spacers .031 [0.79] Thick  
2 - Lock Washers  
2 - 4-40 Nuts

Material: Steel  
Finish: Zinc with Clear Chromate  
Screw / Socket Thread Size: #4-40 / #4-40  
Recommended Max. Torque: 7.0 inch-lbf [0.8 N-m]

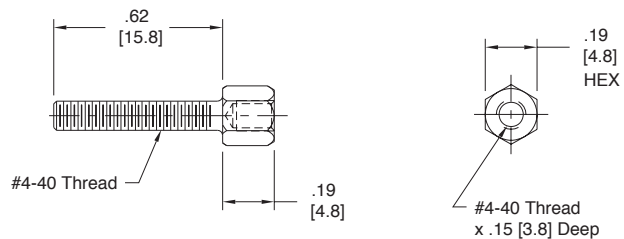

TS-0142-J  
Sheet 2 of 9

# 3M™ I/O Connector Mounting Options and Hardware

## 3M Part Number 3341-10

Material: Stainless Steel  
Screw / Socket Thread Size: M2.5 / M2.5  
Recommended Max. Torque: 2.5 inch-lbf [0.3 N-m]

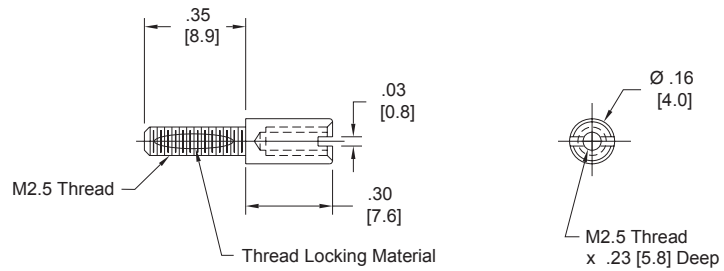

## 3M Part Number 3341-13

Material: Stainless Steel  
Screw / Socket Thread Size: M2.5 / #4-40  
Recommended Max. Torque: 2.5 inch-lbf [0.3 N-m]

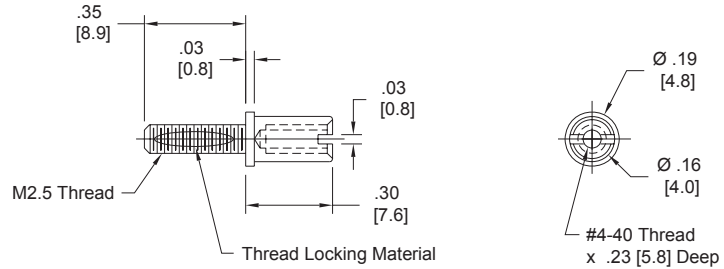

## 3M Part Number 3341-16

Material: Stainless Steel  
Screw / Socket Thread Size: #4-40 / #4-40  
Recommended Max. Torque: 3.5 inch-lbf [0.4 N-m]

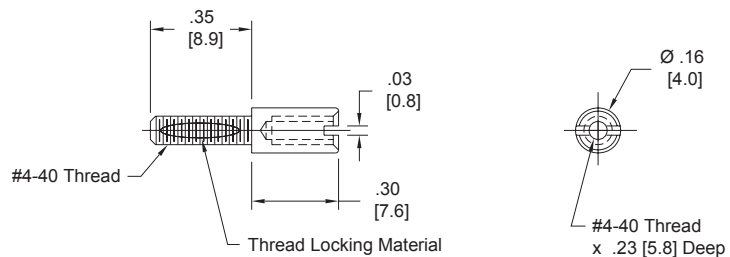

## 3M Part Number 3341-17

Material: Stainless Steel  
Screw / Socket Thread Size: #4-40 / #4-40  
Recommended Max. Torque: 3.5 inch-lbf [0.4 N-m]

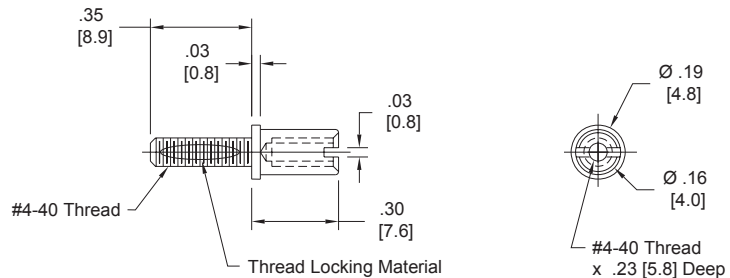

## 3M Part Number 3341-25

Material: Stainless Steel  
Screw / Socket Thread Size: M2.5 / M2  
Recommended Max. Torque: 2.5 inch-lbf [0.3 N-m]

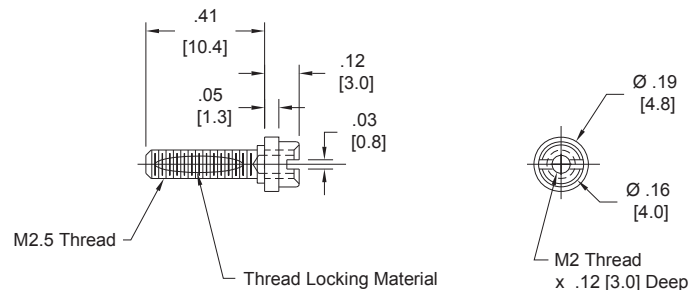

TS-0142-J  
Sheet 3 of 9

# 3M™ I/O Connector Mounting Options and Hardware

## 3M Part Number 3341-30

Material: Stainless Steel  
Screw / Socket Thread Size: #4-40 / #4-40  
Recommended Max. Torque: 3.5 inch-lbf [0.4 N-m]



## 3M Part Number 3341-31

Material: Stainless Steel  
Screw / Socket Thread Size: M2.5 / #4-40  
Recommended Max. Torque: 2.5 inch-lbf [0.3 N-m]



## 3M Part Number 3341-32

Material: Stainless Steel  
Screw / Socket Thread Size: M2.5 / #4-40  
Recommended Max. Torque: 2.5 inch-lbf [0.3 N-m]



## 3M Part Number 3341-35

Material: Stainless Steel  
Screw / Socket Thread Size: M2.5 / #4-40  
Recommended Max. Torque: 2.5 inch-lbf [0.3 N-m]



## 3M Part Number 3341-36

Material: Stainless Steel  
Screw / Socket Thread Size: M2.5 / M2.5  
Recommended Max. Torque: 2.5 inch-lbf [0.3 N-m]

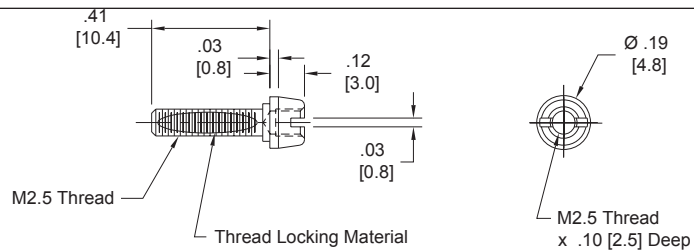

# 3M™ I/O Connector Mounting Options and Hardware

## Jack Screw Kits

### 3M Part Number 3342-1

Kit Contents:  
2 - Clips  
2 - Jack Screws

Material: Steel  
Finish: Zinc with Clear Chromate  
Thread size: #4-40  
Recommended Max. Torque: 7.0 inch-lbf [0.8 N-m]

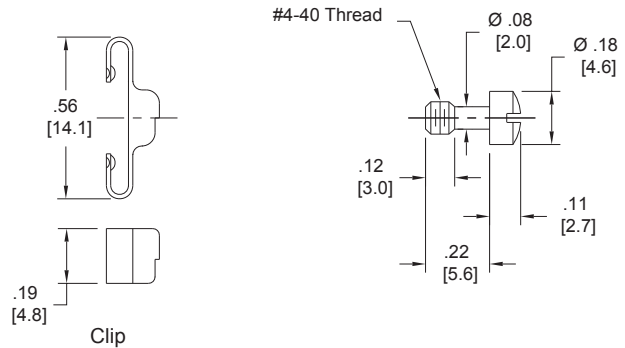

### 3M Part Number 3342-2

Kit Contents:  
2 - Spacers  
2 - Jack Screws

Material: Steel  
Finish: Zinc with Clear Chromate  
Thread size: #4-40  
Recommended Max. Torque: 7.0 inch-lbf [0.8 N-m]

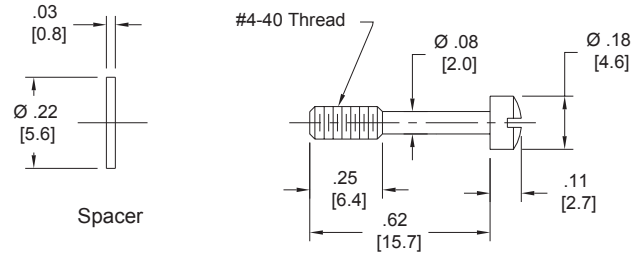

### 3M Part Number 3342-3

Kit Contents:  
2 - Screws  
2 - Jack Screws

Material: Steel  
Finish: Zinc with Clear Chromate  
Thread size: #4-40  
Recommended Max. Torque: 7.0 inch-lbf [0.8 N-m]

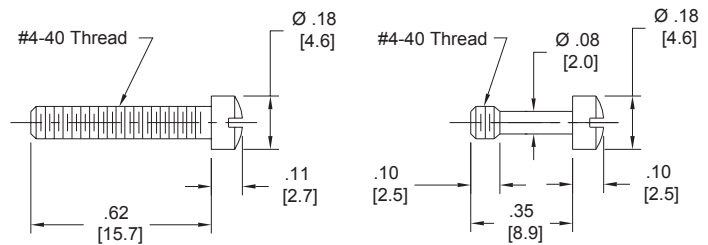

### 3M Part Number 3342-4

Material: Steel  
Finish: Zinc with Clear Chromate  
Thread size: #4-40  
Recommended Max. Torque: 7.0 inch-lbf [0.8 N-m]

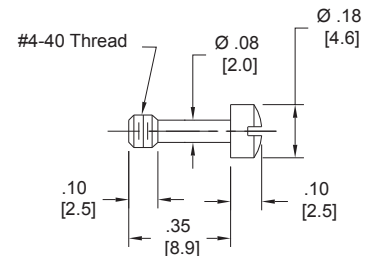

TS-0142-J  
Sheet 5 of 9

# 3M™ I/O Connector Mounting Options and Hardware

## Board Lock Screws

Use to attach connector to printed circuit board. Not for use for panel mounting.

### 3M Part Number 3344-3

Material: Steel  
Finish: Nickel Plated  
Thread size: M2.5  
Recommended Max. Torque: 2.5 inch-lbf [0.3 N-m]



### 3M Part Number 3344-4

Material: Steel  
Finish: Nickel Plated  
Thread size: #4-40  
Recommended Max. Torque: 3.5 inch-lbf [0.4 N-m]

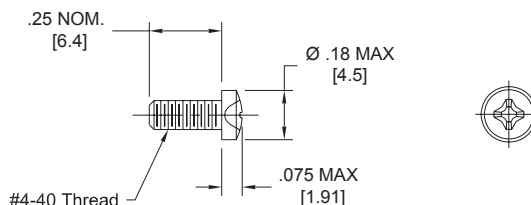

## Panel Mount Screws

Use to attach connector to panel or chassis. Not for use for PCB mounting.

### 3M Part Number 3344-26

Material: Steel  
Finish: Zinc  
Thread size: M2.6  
Recommended Max. Torque: 2.5 inch-lbf [0.3 N-m]



### 3M Part Number 3344-38

Material: Steel  
Finish: Zinc  
Thread size: M2.5  
Recommended Max. Torque: 2.5 inch-lbf [0.3 N-m]

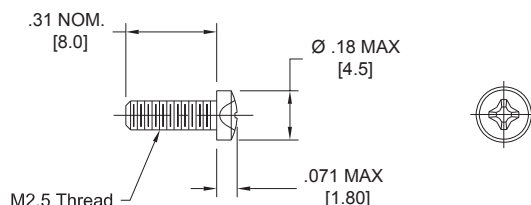

### 3M Part Number 3344-44

Material: Steel  
Finish: Zinc  
Thread size: #4-40  
Recommended Max. Torque: 3.5 inch-lbf [0.4 N-m]

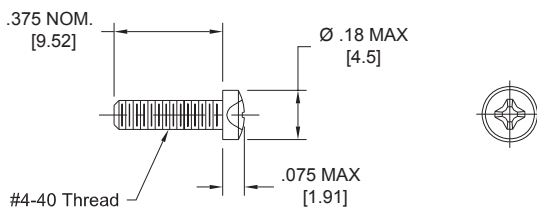

### 3M Part Number 3344-45

Material: Stainless Steel  
Thread size: M2.5  
Recommended Max. Torque: 2.5 inch-lbf [0.3 N-m]

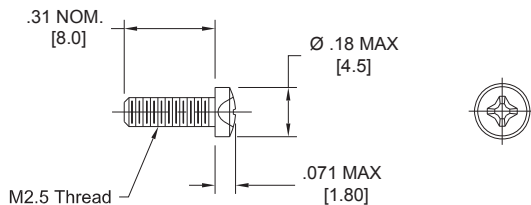

TS-0142-J  
Sheet 6 of 9



# 3M™ I/O Connector Mounting Options and Hardware

## Bail Mount Kits for D Ribbon Connectors



Plastic Connectors  
Mounted to Front of Panel



Plastic & Metal Faced Connectors  
Mounted to Rear of  
.0625, .075, .125 Panels

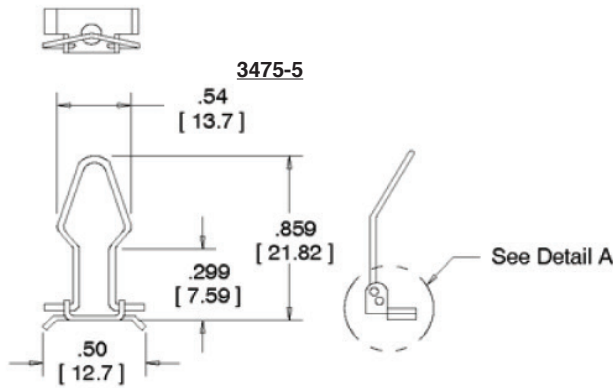

Plastic & Metal Faced Connectors  
Mounted to Rear of  
.035, .042, .094 Panels

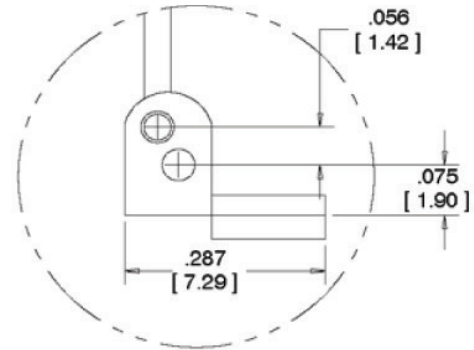

Detail A

Material	
Bail Assy.	Steel, Zinc plated
Screw	Steel, Zinc plated
Nut	Steel, Zinc plated
Washer	Steel, Zinc plated

Kits Contain 2 ea.  
Bail Assy.  
Screw - 4-40 x .50. RND HD SLTD  
Nut - #4-40 UNC  
Washer - Lock-split

### D-Ribbon & Plastic Connectors

Contact Quantity	Mating Connectors		Junction Shell	Strain Relief	Pull-Tab
	Plug	Socket	Plastic		
14	3572-100X	3573-100X	3485-1800Y	3448-60	3490-2
24	3548-100X	3549-100X	3485-1700Y	3448-61	3490-2
36	3366-100X	3367-100X	3485-2800Y	3448-62	3490-3
50	3564-100X	3565-100X	3485-2500Y	3448-63	3490-5

Options:  
X = mounting style  
Y = "F" for flat cable, "R" for round cable

Inch [mm]			
Tolerance Unless Noted			
	.0	.00	.000
Inch	± .1	± .01	± .005

[ ] Dimensions for Reference only

TS-0142-J  
Sheet 7 of 9

# 3M™ I/O Connector Mounting Options and Hardware

## Jack Socket Screws

Use to attach connector to panel or chassis. Not for use for PC board mounting.

### 3M Part Number 12600-S-08

For .03" [0.8 mm] Panel Thickness

Material: Steel  
Finish: Nickel Plated  
Screw / Socket Thread Size: M2 / M2  
Recommended Max. Torque: 2.5 inch-lbf [0.3 N-m]

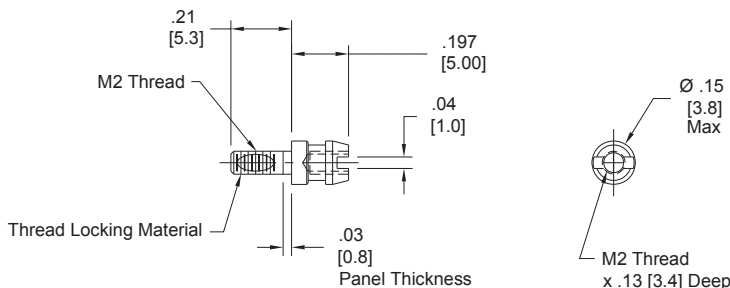

### 3M Part Number 12600-S-10

For .04" [1.0 mm] Panel Thickness

Material: Steel  
Finish: Nickel Plated  
Screw / Socket Thread Size: M2 / M2  
Recommended Max. Torque: 2.5 inch-lbf [0.3 N-m]

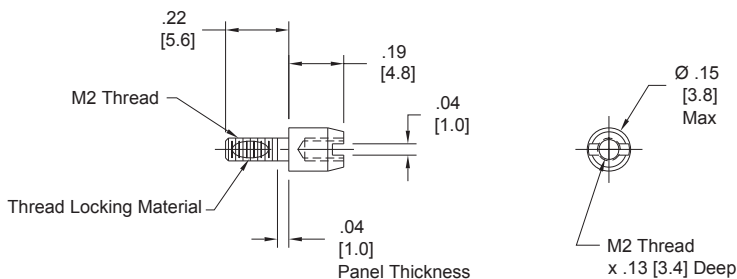

### 3M Part Number 12600-S-12

For .05" [1.2 mm] Panel Thickness

Material: Steel  
Finish: Nickel Plated  
Screw / Socket Thread Size: M2 / M2  
Recommended Max. Torque: 2.5 inch-lbf [0.3 N-m]

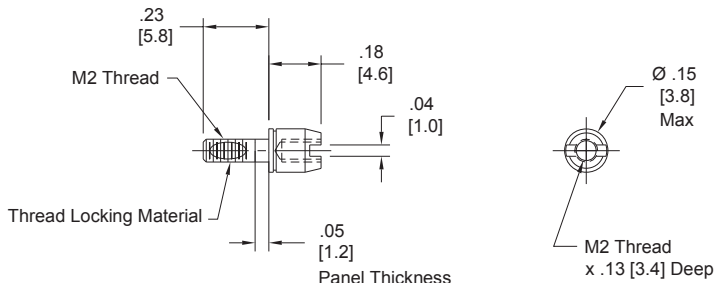

## Board Lock Screw

Use to attach connector to printed circuit board. Not for use for panel mounting.

### 3M Part Number 3344-46

Material: Stainless Steel  
Thread size: M2  
Recommended Max. Torque: 2.5 inch-lbf [0.3 N-m]

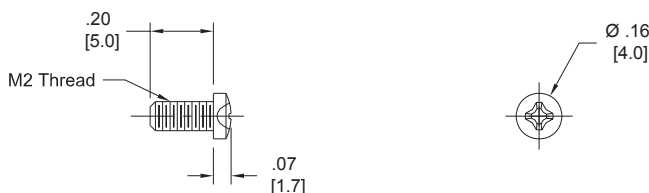

TS-0142-J  
Sheet 8 of 9



# 3M™ I/O Connector Mounting Options and Hardware

## D Sub Connectors

### Mounting Hardware Guide

#### Selection Guide - 9 to 37 Position D Sub Connectors

1. To mount a connector to a panel, select the correct Jack Socket Kit from table 1.
2. To secure a mating connector to a panel mounted connector, select the correct Jack Screw Kit from table 2.
3. To secure two connectors together in a mid-span application where no panel exists, select both the Jack Socket Kit and Jack Screw Kit from table 2.

Panel Mounted Connectors Jack Socket Kits				
Panel Thickness	Front Mount		Rear Mount	
	Kit	Spacers	Kit	Spacers
1/16	3341-1L	2	3341-1L	0
3/32	3341-1L	2	3341-1S	1
1/8	3341-4	2	3341-1S	0

Note: Spacers Placed Under Head of Jack Sockets

Junction Shell	Connectors with Junction Shells		
	Jack Screw Kit	Spacers	Jack Socket Kit
-----	3342-1	-----	3341-1L
3485-2X00	3342-2	2	3341-4
3357-41XX	3342-2	2	3341-4
3357-51XX	3342-2	2	3341-4
3357-65XX	3342-x Supplied	-----	3341-4
3357-92XX	3342-x Supplied or 3341-7		3341-1L

Notes:

1. Jack Sockets used for MidSpan Applications.
2. Spacers Placed Under Head of Jack Screws.

#### Selection Guide - 50 Position D Sub Connectors See TS-0034 Socket and TS-0035 Plug.

Mounting Options Using 3357-9250 Junction Shell & 3505-62 Latch Bracket. See TS-0245.

Front Panel Mounted Connectors:

Connectors not designed for this application

Rear Panel Mounted Connectors:

1/16" Panel: 1 Spacer Latch Bracket and Panel

3/32" Panel: No Spacers.

>3/32" Panel: Latch Bracket not designed for these applications.

Mid-Span Applications: Mount Latch Bracket directly to either the Plug or Socket Connector.

TS-0142-J  
Sheet 9 of 9



**Important Notice**

All statements, technical information, and recommendations related to 3M's products are based on information believed to be reliable, but the accuracy or completeness is not guaranteed. Before using this product, you must evaluate it and determine if it is suitable for your intended application. You assume all risks and liability associated with such use. Any statements related to the product which are not contained in 3M's current publications, or any contrary statements contained on your purchase order shall have no force or effect unless expressly agreed upon, in writing, by an authorized officer of 3M.

**Warranty; Limited Remedy; Limited Liability.**

This product will be free from defects in material and manufacture for a period of one (1) year from the time of purchase. **3M MAKES NO OTHER WARRANTIES INCLUDING, BUT NOT LIMITED TO, ANY IMPLIED WARRANTY OF MERCHANTABILITY OR FITNESS FOR A PARTICULAR PURPOSE.** If this product is defective within the warranty period stated above, your exclusive remedy shall be, at 3M's option, to replace or repair the 3M product or refund the purchase price of the 3M product. **Except where prohibited by law, 3M will not be liable for any indirect, special, incidental or consequential loss or damage arising from this 3M product, regardless of the legal theory asserted.**

**3M Electronics Solutions Division**

6801 River Place Blvd.  
Austin, TX 78726-9000  
U.S.A.  
1-800-225-5373  
[www.3Mconnectors.com](http://www.3Mconnectors.com)

Please recycle. Printed in USA.  
© 3M 2012. All rights reserved.  
RIA-2217B-E

3M is a trademark of 3M Company.

## Данный компонент на территории Российской Федерации

### Вы можете приобрести в компании MosChip.

Для оперативного оформления запроса Вам необходимо перейти по данной ссылке:

<http://moschip.ru/get-element>

Вы можете разместить у нас заказ для любого Вашего проекта, будь то серийное производство или разработка единичного прибора.

В нашем ассортименте представлены ведущие мировые производители активных и пассивных электронных компонентов.

Нашей специализацией является поставка электронной компонентной базы двойного назначения, продукции таких производителей как XILINX, Intel (ex.ALTERA), Vicor, Microchip, Texas Instruments, Analog Devices, Mini-Circuits, Amphenol, Glenair.

Сотрудничество с глобальными дистрибьюторами электронных компонентов, предоставляет возможность заказывать и получать с международных складов практически любой перечень компонентов в оптимальные для Вас сроки.

На всех этапах разработки и производства наши партнеры могут получить квалифицированную поддержку опытных инженеров.

Система менеджмента качества компании отвечает требованиям в соответствии с ГОСТ Р ИСО 9001, ГОСТ РВ 0015-002 и ЭС РД 009

### Офис по работе с юридическими лицами:

105318, г.Москва, ул.Щербаковская д.3, офис 1107, 1118, ДЦ «Щербаковский»

Телефон: +7 495 668-12-70 (многоканальный)

Факс: +7 495 668-12-70 (доб.304)

E-mail: [info@moschip.ru](mailto:info@moschip.ru)

Skype отдела продаж:

moschip.ru

moschip.ru\_4

moschip.ru\_6

moschip.ru\_9