



Is Now Part of



**ON Semiconductor®**

To learn more about ON Semiconductor, please visit our website at  
[www.onsemi.com](http://www.onsemi.com)

Please note: As part of the Fairchild Semiconductor integration, some of the Fairchild orderable part numbers will need to change in order to meet ON Semiconductor's system requirements. Since the ON Semiconductor product management systems do not have the ability to manage part nomenclature that utilizes an underscore (\_), the underscore (\_) in the Fairchild part numbers will be changed to a dash (-). This document may contain device numbers with an underscore (\_). Please check the ON Semiconductor website to verify the updated device numbers. The most current and up-to-date ordering information can be found at [www.onsemi.com](http://www.onsemi.com). Please email any questions regarding the system integration to [Fairchild\\_questions@onsemi.com](mailto:Fairchild_questions@onsemi.com).

ON Semiconductor and the ON Semiconductor logo are trademarks of Semiconductor Components Industries, LLC dba ON Semiconductor or its subsidiaries in the United States and/or other countries. ON Semiconductor owns the rights to a number of patents, trademarks, copyrights, trade secrets, and other intellectual property. A listing of ON Semiconductor's product/patent coverage may be accessed at [www.onsemi.com/site/pdf/Patent-Marking.pdf](http://www.onsemi.com/site/pdf/Patent-Marking.pdf). ON Semiconductor reserves the right to make changes without further notice to any products herein. ON Semiconductor makes no warranty, representation or guarantee regarding the suitability of its products for any particular purpose, nor does ON Semiconductor assume any liability arising out of the application or use of any product or circuit, and specifically disclaims any and all liability, including without limitation special, consequential or incidental damages. Buyer is responsible for its products and applications using ON Semiconductor products, including compliance with all laws, regulations and safety requirements or standards, regardless of any support or applications information provided by ON Semiconductor. "Typical" parameters which may be provided in ON Semiconductor data sheets and/or specifications can and do vary in different applications and actual performance may vary over time. All operating parameters, including "Typicals" must be validated for each customer application by customer's technical experts. ON Semiconductor does not convey any license under its patent rights nor the rights of others. ON Semiconductor products are not designed, intended, or authorized for use as a critical component in life support systems or any FDA Class 3 medical devices or medical devices with a same or similar classification in a foreign jurisdiction or any devices intended for implantation in the human body. Should Buyer purchase or use ON Semiconductor products for any such unintended or unauthorized application, Buyer shall indemnify and hold ON Semiconductor and its officers, employees, subsidiaries, affiliates, and distributors harmless against all claims, costs, damages, and expenses, and reasonable attorney fees arising out of, directly or indirectly, any claim of personal injury or death associated with such unintended or unauthorized use, even if such claim alleges that ON Semiconductor was negligent regarding the design or manufacture of the part. ON Semiconductor is an Equal Opportunity/Affirmative Action Employer. This literature is subject to all applicable copyright laws and is not for resale in any manner.



# FAN7393A

## Half-Bridge Gate Drive IC

### Features

- Floating Channel for Bootstrap Operation to +600V
- Typically 2.5A/2.5A Sourcing/Sinking Current Driving Capability
- Extended Allowable Negative  $V_S$  Swing to -9.8V for Signal Propagation at  $V_{BS}=15V$
- High-Side Output in Phase of IN Input Signal
- 3.3V and 5V Input Logic Compatible
- Matched Propagation Delay for Both Channels
- Built-in Shutdown Function
- Built-in UVLO Functions for Both Channels
- Built-in Common-Mode dv/dt Noise Cancelling Circuit
- Internal 400ns Minimum Dead Time at  $R_{DT}=0\Omega$
- Programmable Turn-On Delay Control (Dead-Time)

### Applications

- High-Speed Power MOSFET and IGBT Gate Driver
- Induction Heating
- High-Power DC-DC Converter
- Synchronous Step-Down Converter
- Motor Drive Inverter

### Description

The FAN7393A is a half-bridge gate-drive IC with shut-down and programmable dead-time control functions that can drive high-speed MOSFETs and Isolated Gate Bridge Transistors (IGBTs) operating up to +600V. It has a buffered output stage with all NMOS transistors designed for high-pulse-current driving capability and minimum cross-conduction.

Fairchild's high-voltage process and common-mode noise canceling techniques provide stable operation of the high-side driver under high dv/dt noise circumstances. An advanced level-shift circuit offers high-side gate driver operation up to  $V_S=-9.8V$  (typical) for  $V_{BS}=15V$ .

The UVLO circuit prevents malfunction when  $V_{DD}$  and  $V_{BS}$  are lower than the specified threshold voltage.

The high-current and low-output voltage drop feature makes this device suitable for diverse half- and full-bridge inverters; motor drive inverters, switching mode power supplies, induction heating, and high-power DC-DC converter applications.

14-SOP



### Ordering Information

Part Number	Package	Operating Temperature	Packing Method
FAN7393AMX	14-SOIC	-40°C to +125°C	Tape & Reel

### Typical Application Diagrams

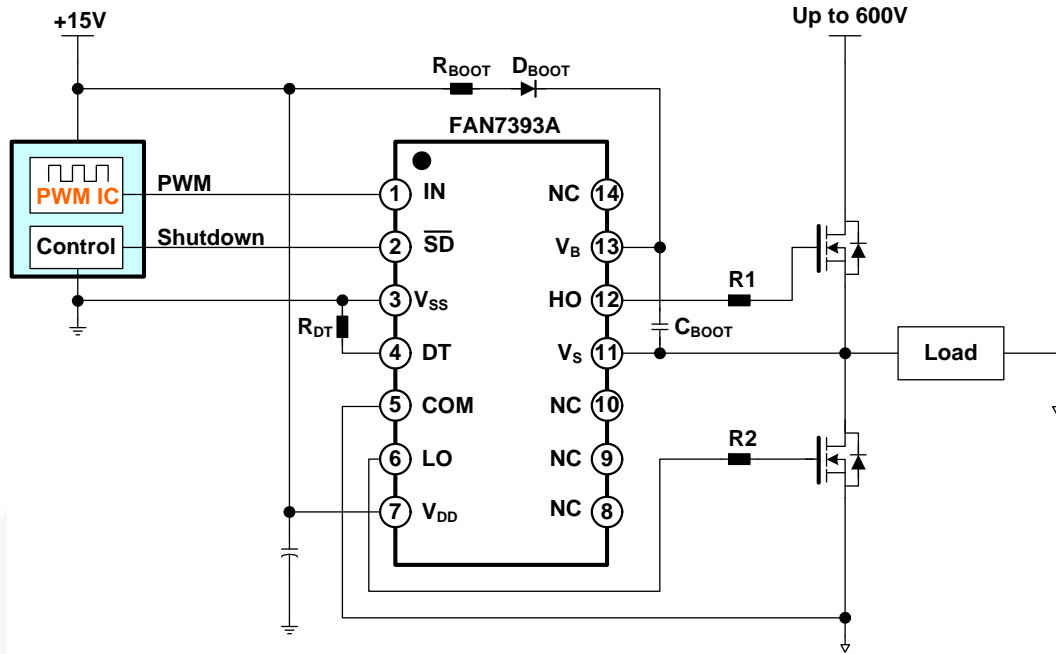

Figure 1. Typical Application Circuit

### Internal Block Diagram

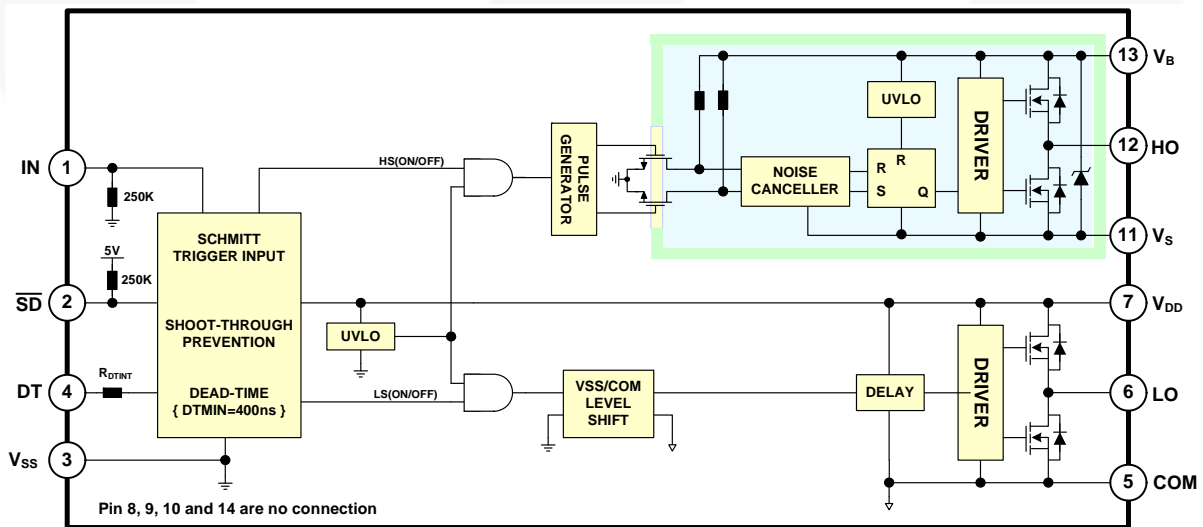

Figure 2. Functional Block Diagram

## Pin Configuration

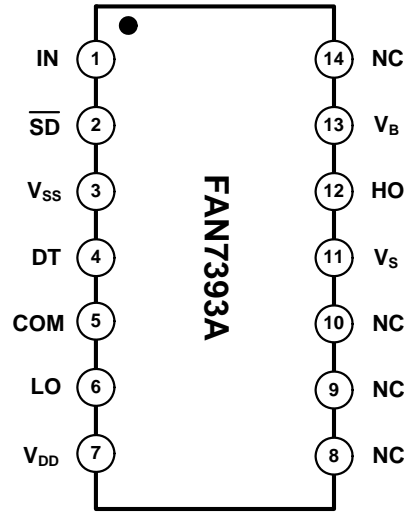

Figure 3. Pin Configurations (Top View)

## Pin Definitions

Pin #	Name	Description
1	IN	Logic Input for High-Side and Low-Side Gate Driver Output, In-Phase with HO
2	$\overline{\text{SD}}$	Logic Input for Shutdown
3	$V_{SS}$	Logic Ground
4	DT	Dead-Time Control with External Resistor (Referenced to $V_{SS}$ )
5	COM	Ground
6	LO	Low-Side Driver Return
7	$V_{DD}$	Supply Voltage
8	NC	No Connection
9	NC	No Connection
10	NC	No Connection
11	$V_S$	High-Voltage Floating Supply Return
12	HO	High-Side Driver Output
13	$V_B$	High-Side Floating Supply
14	NC	No Connection

## Absolute Maximum Ratings

Stresses exceeding the absolute maximum ratings may damage the device. The device may not function or be operable above the recommended operating conditions and stressing the parts to these levels is not recommended. In addition, extended exposure to stresses above the recommended operating conditions may affect device reliability. The absolute maximum ratings are stress ratings only.  $T_A=25^{\circ}\text{C}$  unless otherwise specified.

Symbol	Characteristics	Min.	Max.	Unit
$V_B$	High-Side Floating Supply Voltage	-0.3	625.0	V
$V_S$	High-Side Floating Offset Voltage <sup>(1)</sup>	$V_B-V_{SHUNT}$	$V_B+0.3$	V
$V_{HO}$	High-Side Floating Output Voltage	$V_S-0.3$	$V_B+0.3$	V
$V_{LO}$	Low-Side Output Voltage	-0.3	$V_{DD}+0.3$	V
$V_{DD}$	Low-Side and Logic Fixed Supply Voltage	-0.3	25.0	V
$V_{IN}$	Logic Input Voltage (IN)	-0.3	$V_{DD}+0.3$	V
$V_{SD}$	Logic Input Voltage ( $\overline{SD}$ )	$V_{SS}$	5.5	V
DT	Programmable Dead-Time Pin Voltage	-0.3	$V_{DD}+0.3$	V
$V_{SS}$	Logic Ground	$V_{DD}-25$	$V_{DD}+0.3$	V
$dV_S/dt$	Allowable Offset Voltage Slew Rate		$\pm 50$	V/ns
$P_D$	Power Dissipation <sup>(2, 3, 4)</sup>		1	W
$\theta_{JA}$	Thermal Resistance		110	$^{\circ}\text{C}/\text{W}$
$T_J$	Junction Temperature		+150	$^{\circ}\text{C}$
$T_{STG}$	Storage Temperature	-55	+150	$^{\circ}\text{C}$

### Notes:

- This IC contains a shunt regulator on  $V_{BS}$ . This supply pin should not be driven by a low-impedance voltage source greater than  $V_{SHUNT}$  specified in the Electrical Characteristics section.
- Mounted on 76.2 x 114.3 x 1.6mm PCB (FR-4 glass epoxy material).
- Refer to the following standards:  
JESD51-2: Integral circuits thermal test method environmental conditions - natural convection, and  
JESD51-3: Low effective thermal conductivity test board for leaded surface mount packages.
- Do not exceed maximum  $P_D$  under any circumstances.

## Recommended Operating Conditions

The Recommended Operating Conditions table defines the conditions for actual device operation. Recommended operating conditions are specified to ensure optimal performance to the datasheet specifications. Fairchild does not recommend exceeding them or designing to absolute maximum ratings.

Symbol	Parameter	Min.	Max.	Unit
$V_B$	High-Side Floating Supply Voltage	$V_S+10$	$V_S+20$	V
$V_S$	High-Side Floating Supply Offset Voltage	$6-V_{DD}$	600	V
$V_{HO}$	High-Side Output Voltage	$V_S$	$V_B$	V
$V_{DD}$	Low-Side and Logic Fixed Supply Voltage	10	20	V
$V_{LO}$	Low-Side Output Voltage	COM	$V_{DD}$	V
$V_{IN}$	Logic Input Voltage (IN)	$V_{SS}$	$V_{DD}$	V
$V_{SD}$	Logic Input Voltage ( $\overline{SD}$ )	$V_{SS}$	5	V
DT	Programmable Dead-Time Pin Voltage	$V_{SS}$	$V_{DD}$	V
$V_{SS}$	Logic Ground	-5	+5	V
$T_A$	Operating Ambient Temperature	-40	+125	$^{\circ}\text{C}$

## Electrical Characteristics

$V_{BIAS}(V_{DD}, V_{BS})=15.0V$ ,  $V_{SS}=COM=0V$ ,  $DT=V_{SS}$ , and  $T_A=25^\circ C$  unless otherwise specified. The  $V_{IN}$  and  $I_{IN}$  parameters are referenced to  $V_{SS}/COM$  and are applicable to the respective input leads: IN and SD. The  $V_O$  and  $I_O$  parameters are referenced to COM and are applicable to the respective output leads: HO and LO.

Symbol	Characteristics	Test Condition	Min.	Typ.	Max.	Unit
<b>POWER SUPPLY SECTION</b>						
$I_{QDD}$	Quiescent $V_{DD}$ Supply Current	$V_{IN}=0V$ or $5V$		600	1000	$\mu A$
$I_{QBS}$	Quiescent $V_{BS}$ Supply Current	$V_{IN}=0V$ or $5V$		55	100	$\mu A$
$I_{PDD}$	Operating $V_{DD}$ Supply Current	$f_{IN}=20KHz$ , No Load		1.0	1.6	mA
$I_{PBS}$	Operating $V_{BS}$ Supply Current	$C_L=1nF$ , $f_{IN}=20KHz$ , RMS		450	800	$\mu A$
$I_{SD}$	Shutdown Mode Supply Current	$\overline{SD}=V_{SS}$		650	1000	$\mu A$
$I_{LK}$	Offset Supply Leakage Current	$V_B=V_S=600V$			10	$\mu A$
<b>BOOTSTRAPPED SUPPLY SECTION</b>						
$V_{DDUV+}$ $V_{BSUV+}$	$V_{DD}$ and $V_{BS}$ Supply Under-Voltage Positive-Going Threshold Voltage	$V_{IN}=0V$ , $V_{DD}=V_{BS}=\text{Sweep}$	7.8	8.8	9.8	V
$V_{DDUV-}$ $V_{BSUV-}$	$V_{DD}$ and $V_{BS}$ Supply Under-Voltage Negative-Going Threshold Voltage	$V_{IN}=0V$ , $V_{DD}=V_{BS}=\text{Sweep}$	7.3	8.3	9.3	V
$V_{DDUVH-}$ $V_{BSUVH}$	$V_{DD}$ and $V_{BS}$ Supply Under-Voltage Lockout Hysteresis Voltage	$V_{IN}=0V$ , $V_{DD}=V_{BS}=\text{Sweep}$		0.5		V
<b>SHUNT REGULATOR SECTION</b>						
$V_{SHUNT}$	Shunt Regulator Clamping Voltage for $V_{BS}$	$V_{BS}=\text{Sweep}$ , $I_{SHUNT}=5mA$	21	23	25	V
<b>INPUT LOGIC SECTION</b>						
$V_{IH}$	Logic "1" Input Voltage for HO & Logic "0" for LO		2.5			V
$V_{IL}$	Logic "0" Input Voltage for HO & Logic "1" for LO				0.8	V
$I_{IN+}$	Logic Input High Bias Current	$V_{IN}=5V$ , $\overline{SD}=0V$		20	50	$\mu A$
$I_{IN-}$	Logic Input Low Bias Current	$V_{IN}=0V$ , $\overline{SD}=5V$			3	$\mu A$
$R_{IN}$	Logic Input Pull-Down Resistance		100	250		$K\Omega$
$V_{SDCLAMP}$	Shutdown ( $\overline{SD}$ ) Input Clamping Voltage <sup>(5)</sup>			5.0	5.5	V
$\overline{SD+}$	Shutdown ( $\overline{SD}$ ) Input Positive-Going Threshold		2.5			V
$\overline{SD-}$	Shutdown ( $\overline{SD}$ ) Input Negative-Going Threshold				0.8	V
$R_{PSD}$	Shutdown ( $\overline{SD}$ ) Input Pull-Up Resistance		100	250		$K\Omega$
<b>GATE DRIVER OUTPUT SECTION</b>						
$V_{OH}$	High-Level Output Voltage ( $V_{BIAS} - V_O$ )	No Load ( $I_O=0A$ )			1.5	V
$V_{OL}$	Low-Level Output Voltage	No Load ( $I_O=0A$ )			100	mV
$I_{O+}$	Output High, Short-Circuit Pulsed Current <sup>(5)</sup>	$V_{HO}=0V$ , $V_{IN}=5V$ , $PW \leq 10\mu s$	2.0	2.5		A
$I_{O-}$	Output Low, Short-Circuit Pulsed Current <sup>(5)</sup>	$V_{HO}=15V$ , $V_{IN}=0V$ , $PW \leq 10\mu s$	2.0	2.5		A
$V_{SS}/COM$	$V_{SS}-COM/COM-V_{SS}$ Voltage Endurance <sup>(5)</sup>		-5.0		5.0	V
$V_S$	Allowable Negative $V_S$ Pin Voltage for IN Signal Propagation to HO			-9.8	-7.0	V

### Note:

5 These parameters are guaranteed by design.

### Dynamic Electrical Characteristics

$V_{BIAS}(V_{DD}, V_{BS})=15.0V$ ,  $V_{SS}=COM=0V$ ,  $C_L=1000pF$ ,  $DT=V_{SS}$ , and  $T_A=25^\circ C$ , unless otherwise specified.

Symbol	Parameter	Conditions	Min.	Typ.	Max.	Unit
$t_{ON}$	Turn-On Propagation Delay <sup>(6)</sup>	$V_S=0V$ , $R_{DT}=0\Omega$		530	730	ns
$t_{OFF}$	Turn-Off Propagation Delay	$V_S=0V$		130	250	ns
$t_{SD}$	Shutdown Propagation Delay			140	210	ns
$Mt_{ON}$	Delay Matching, HO and LO Turn-On			0	90	ns
$Mt_{OFF}$	Delay Matching, HO and LO Turn-Off			0	40	ns
$t_R$	Turn-On Rise Time	$V_S=0V$		25	50	ns
$t_F$	Turn-Off Fall Time	$V_S=0V$		15	35	ns
DT	Dead Time: LO Turn-Off to HO Turn-On, HO Turn-Off to LO Turn-On	$R_{DT}=0\Omega$	300	400	500	ns
		$R_{DT}=200K\Omega$	4	5	6	$\mu s$
MDT	Dead-Time Matching= $ DT_{LO-HO} - DT_{HO-LO} $	$R_{DT}=0\Omega$		0	40	ns
		$R_{DT}=200K\Omega$		0	500	ns

**Note:**

6 The turn-on propagation delay includes dead time.

## Typical Characteristics

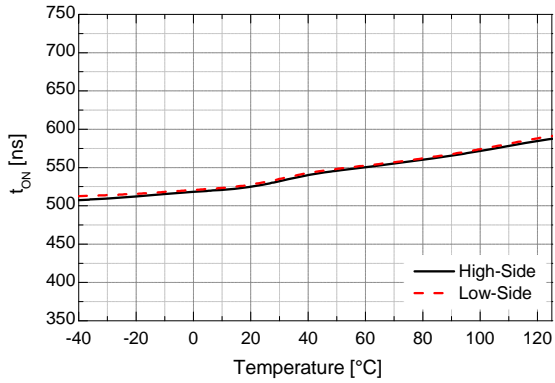

Figure 4. Turn-On Propagation Delay vs. Temperature

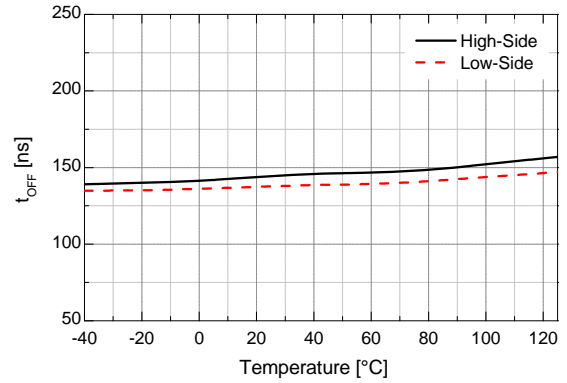

Figure 5. Turn-Off Propagation Delay vs. Temperature

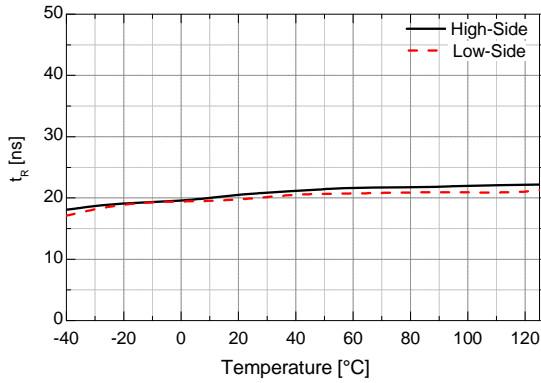

Figure 6. Turn-On Rise Time vs. Temperature

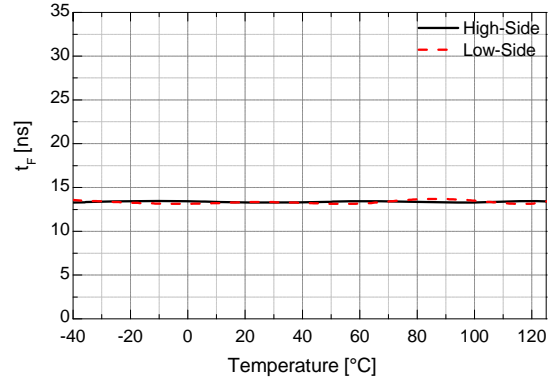

Figure 7. Turn-Off Fall Time vs. Temperature

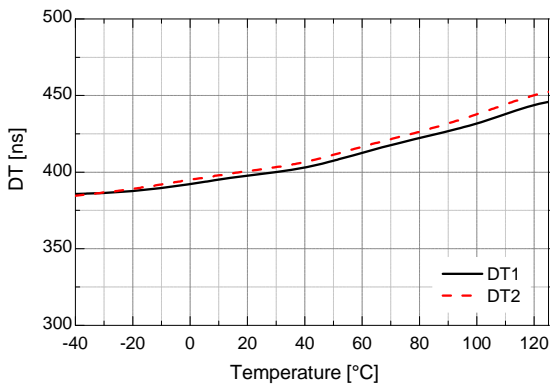

Figure 8. Dead Time ( $R_{DT}=0\Omega$ ) vs. Temperature

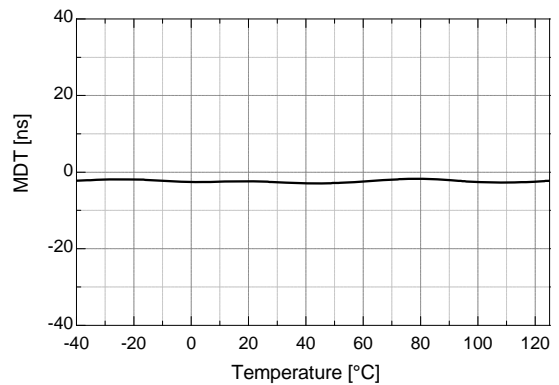

Figure 9. Dead Time Matching ( $R_{DT}=0\Omega$ ) vs. Temperature



Typical Characteristics (Continued)

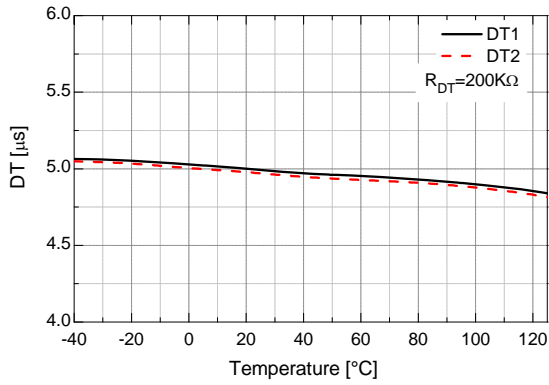

Figure 10. Dead Time ( $R_{DT}=200K\Omega$ ) vs. Temperature

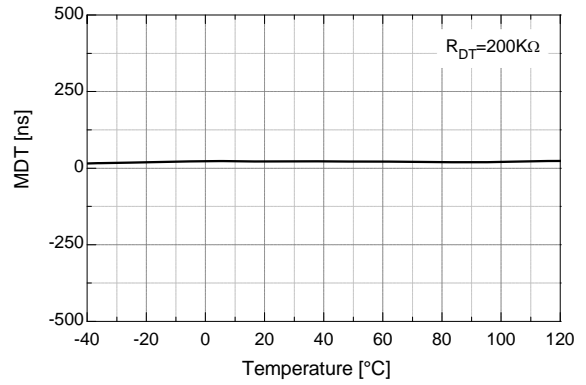

Figure 11. Dead-Time Matching ( $R_{DT}=200K\Omega$ ) vs. Temperature

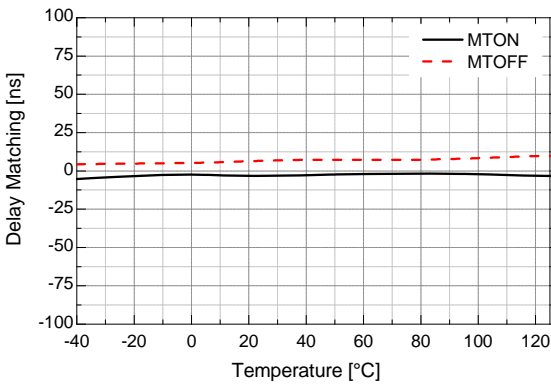

Figure 12. Delay Matching vs. Temperature

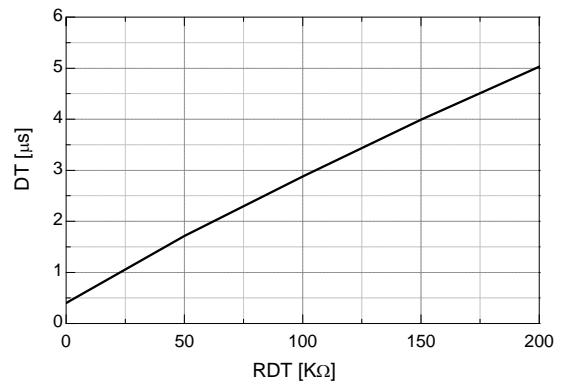

Figure 13. Dead Time vs.  $R_{DT}$

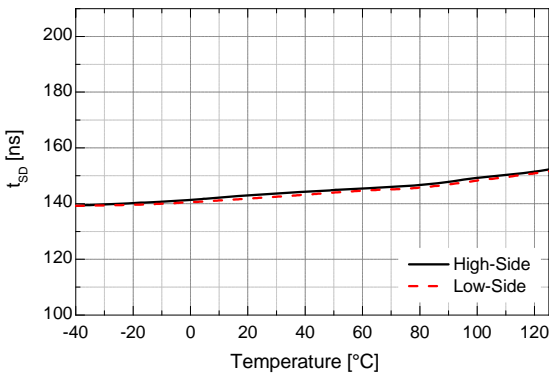

Figure 14. Shutdown Propagation Delay vs. Temperature

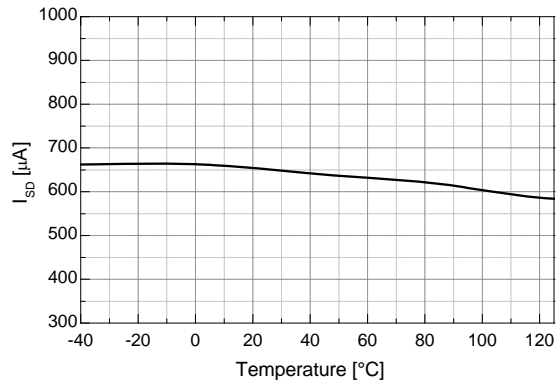

Figure 15. Shutdown Mode Supply Current vs. Temperature

Typical Characteristics (Continued)

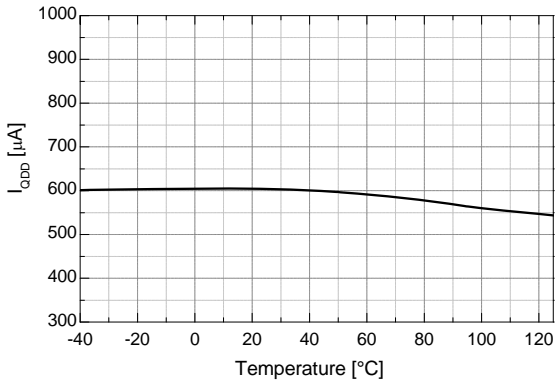

Figure 16. Quiescent  $V_{DD}$  Supply Current vs. Temperature

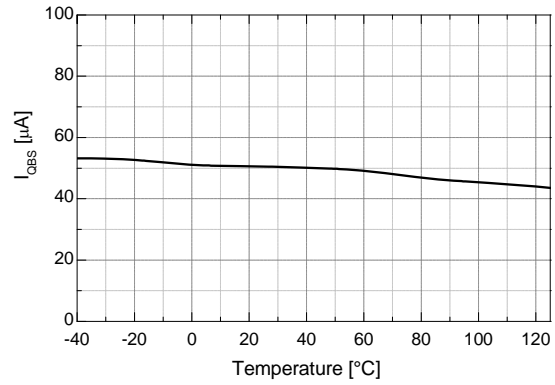

Figure 17. Quiescent  $V_{BS}$  Supply Current vs. Temperature

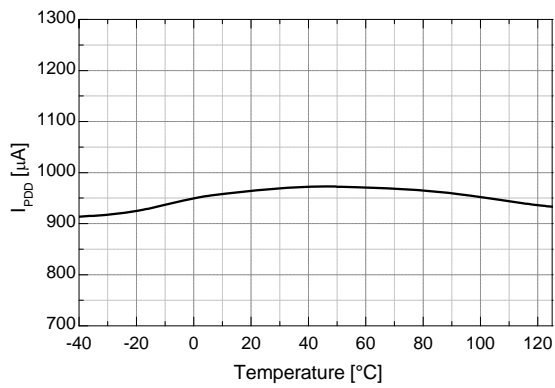

Figure 18. Operating  $V_{DD}$  Supply Current vs. Temperature

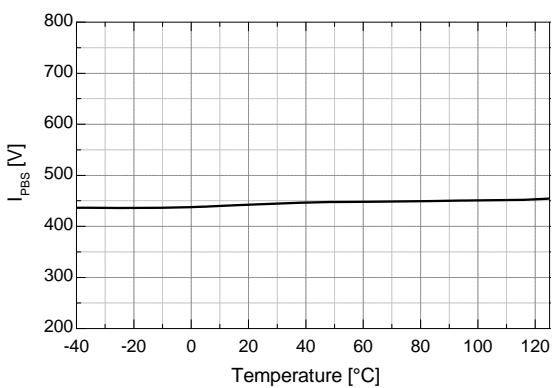

Figure 19. Operating  $V_{BS}$  Supply Current vs. Temperature

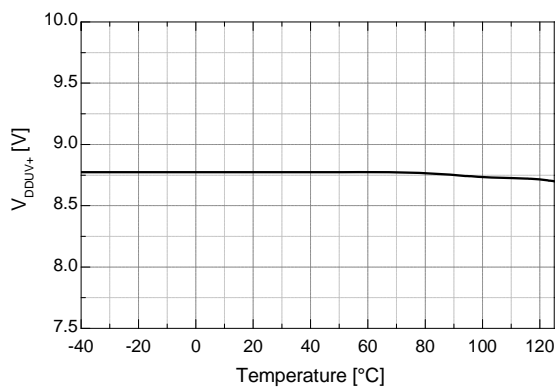

Figure 20.  $V_{DD}$  UVLO+ vs. Temperature

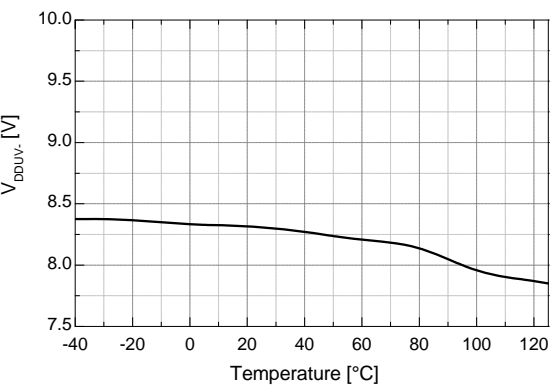

Figure 21.  $V_{DD}$  UVLO- vs. Temperature

Typical Characteristics (Continued)

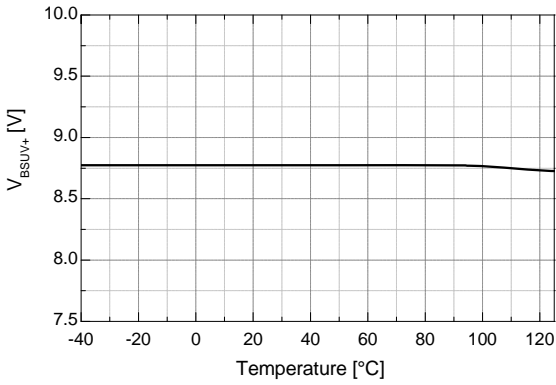

Figure 22.  $V_{BS}$  UVLO+ vs. Temperature

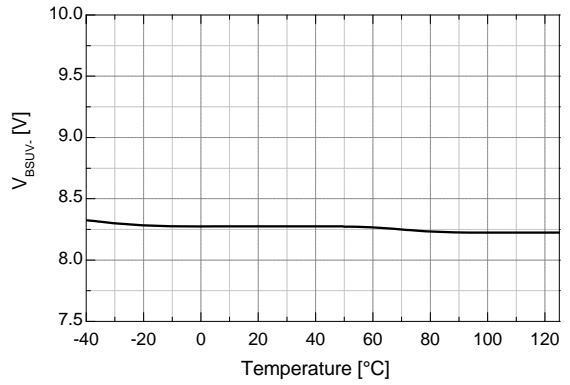

Figure 23.  $V_{BS}$  UVLO- vs. Temperature

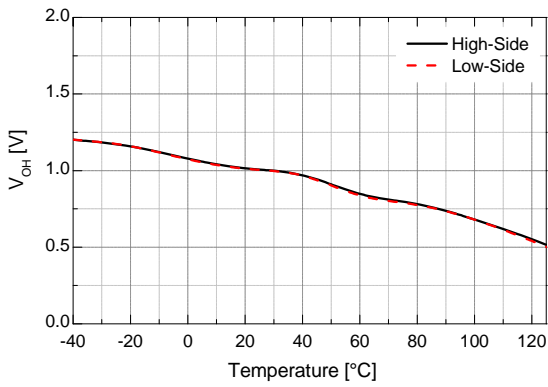

Figure 24. High-Level Output Voltage vs. Temperature

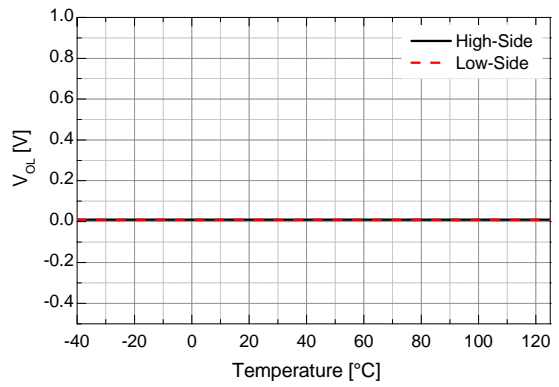

Figure 25. Low-Level Output Voltage vs. Temperature

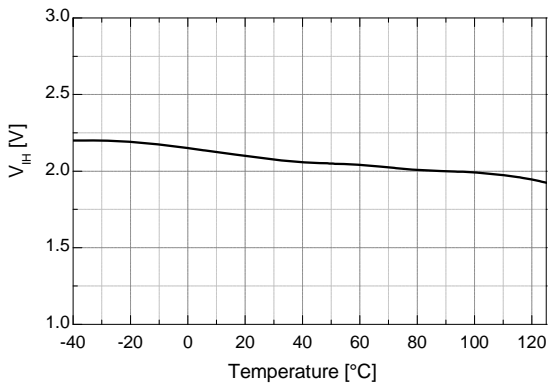

Figure 26. Logic HIGH Input Voltage vs. Temperature

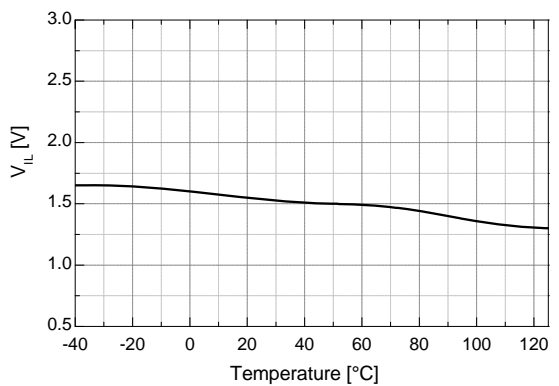

Figure 27. Logic LOW Input Voltage vs. Temperature

Typical Characteristics (Continued)

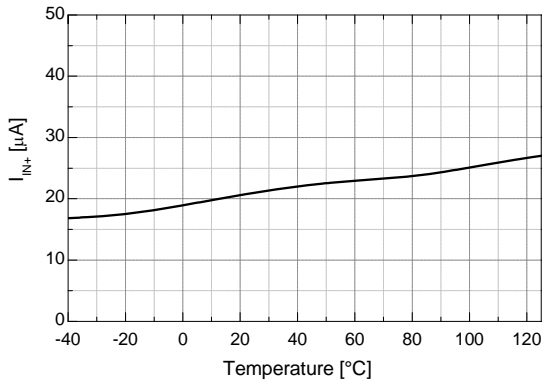

Figure 28. Logic Input High Bias Current vs. Temperature

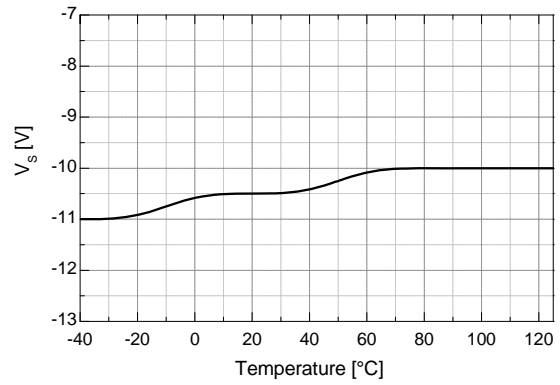

Figure 29. Allowable Negative V<sub>S</sub> Voltage vs. Temperature

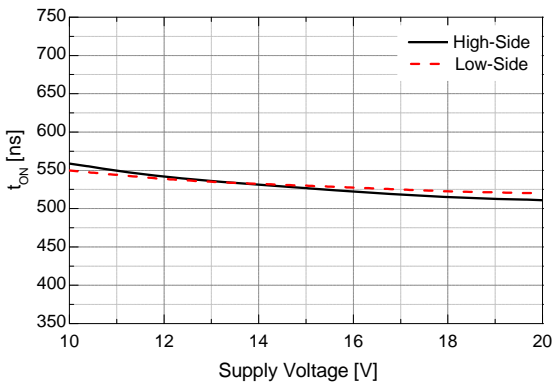

Figure 30. Turn-On Propagation Delay vs. Supply Voltage

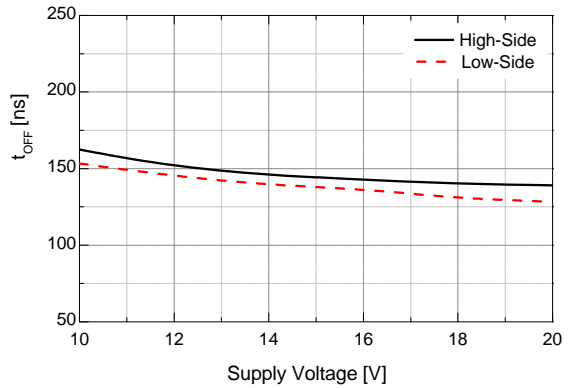

Figure 31. Turn-Off Propagation Delay vs. Supply Voltage

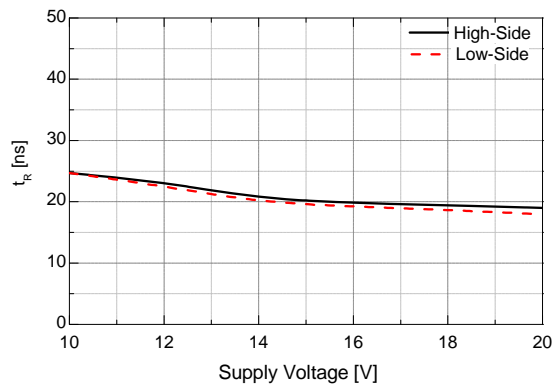

Figure 32. Turn-On Rise Time vs. Supply Voltage

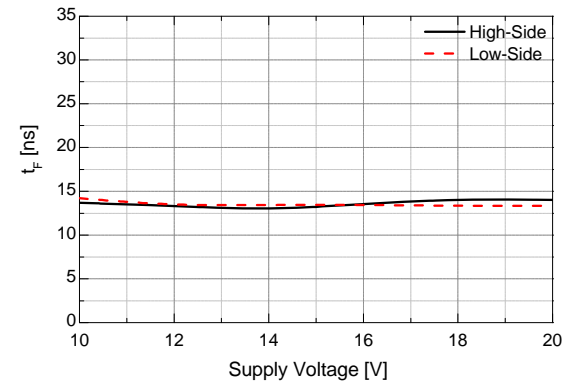

Figure 33. Turn-Off Fall Time vs. Supply Voltage

Typical Characteristics (Continued)

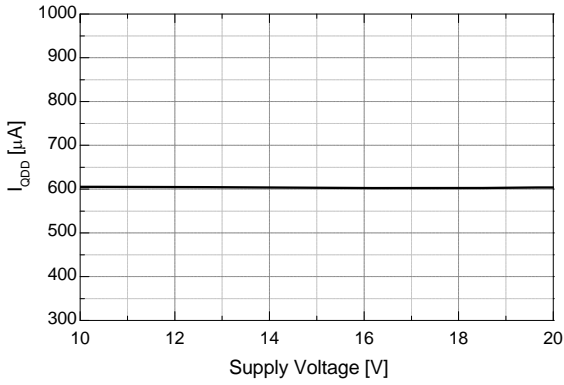

Figure 34. Quiescent  $V_{DD}$  Supply Current vs. Supply Voltage

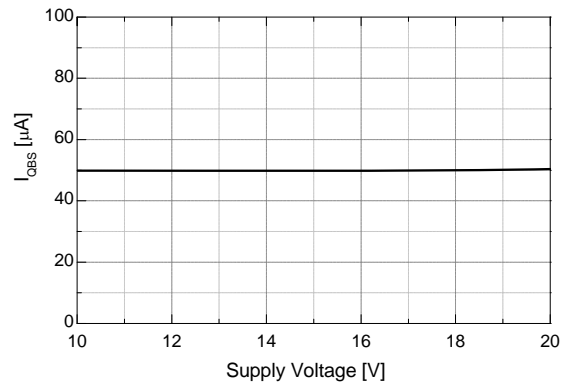

Figure 35. Quiescent  $V_{BS}$  Supply Current vs. Supply Voltage

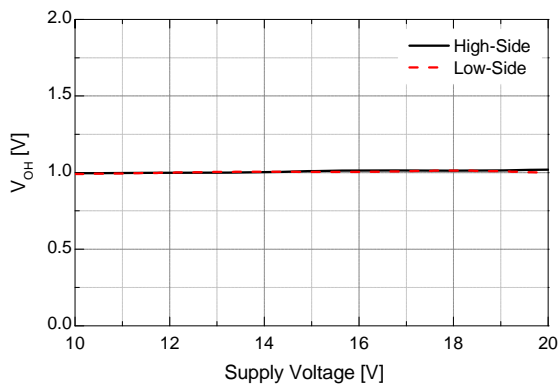

Figure 36. High-Level Output Voltage vs. Supply Voltage

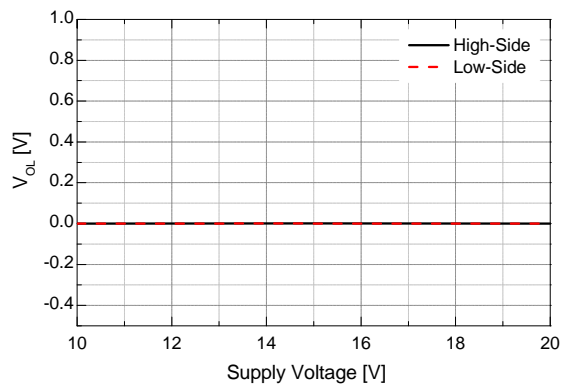

Figure 37. Low-Level Output Voltage vs. Supply Voltage

### Switching Time Definitions

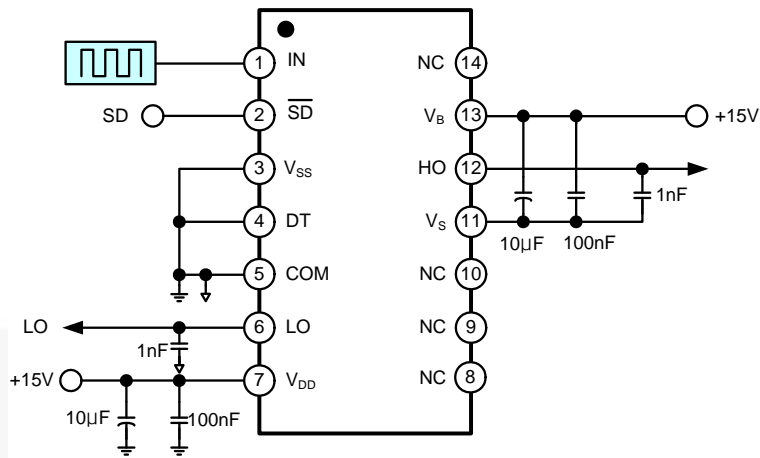

Figure 38. Switching Time Test Circuit

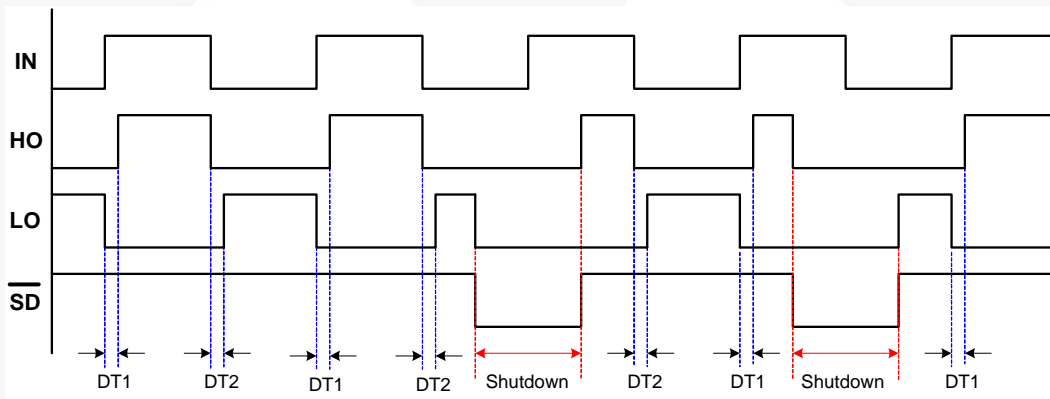

Figure 39. Input / Output Timing Diagram

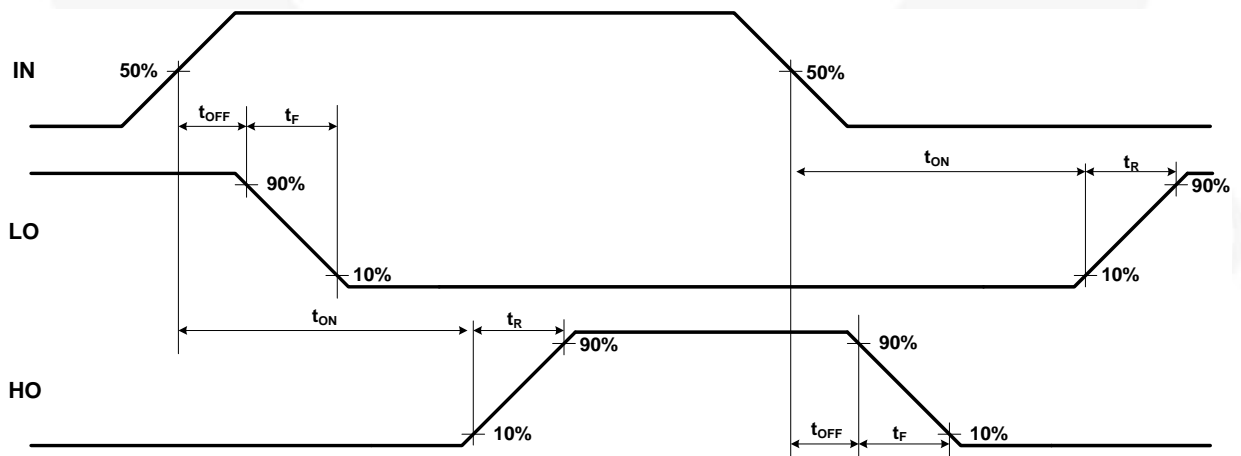

Figure 40. Switching Time Waveform Definition

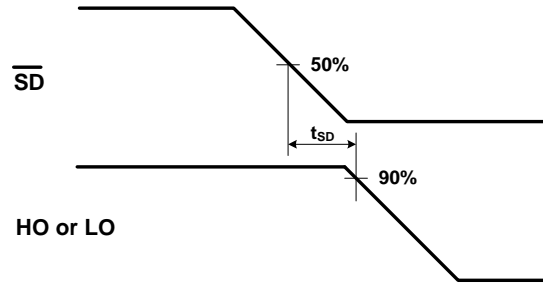

Figure 41. Shutdown Waveform Definition

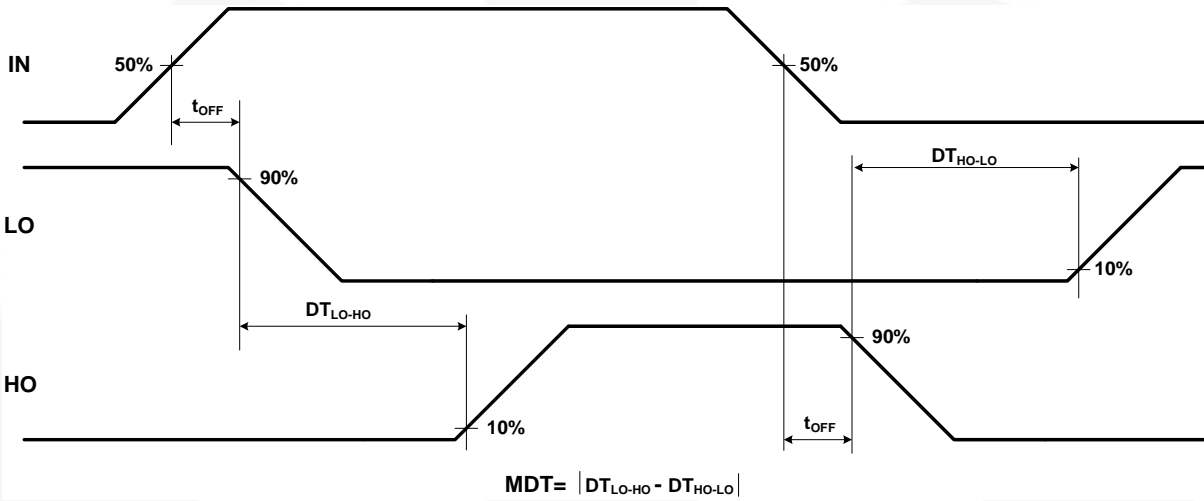

Figure 42. Dead-Time Waveform Definition

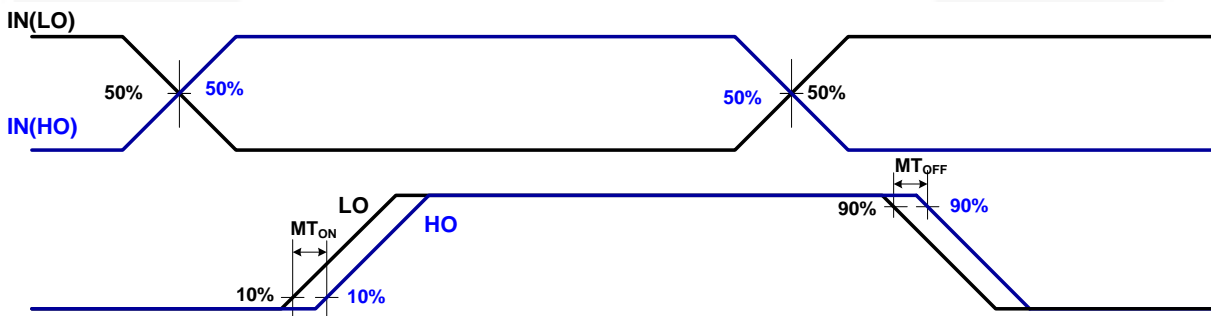
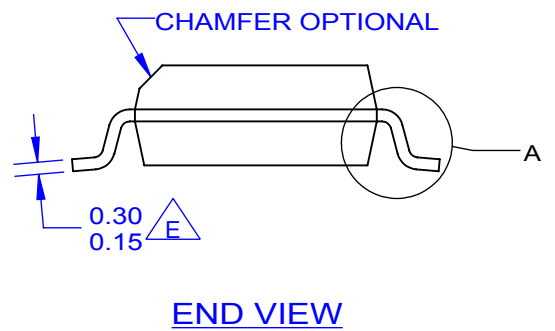
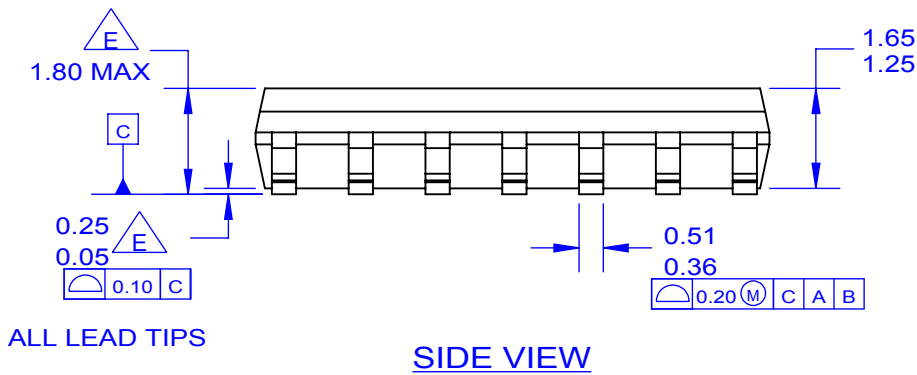
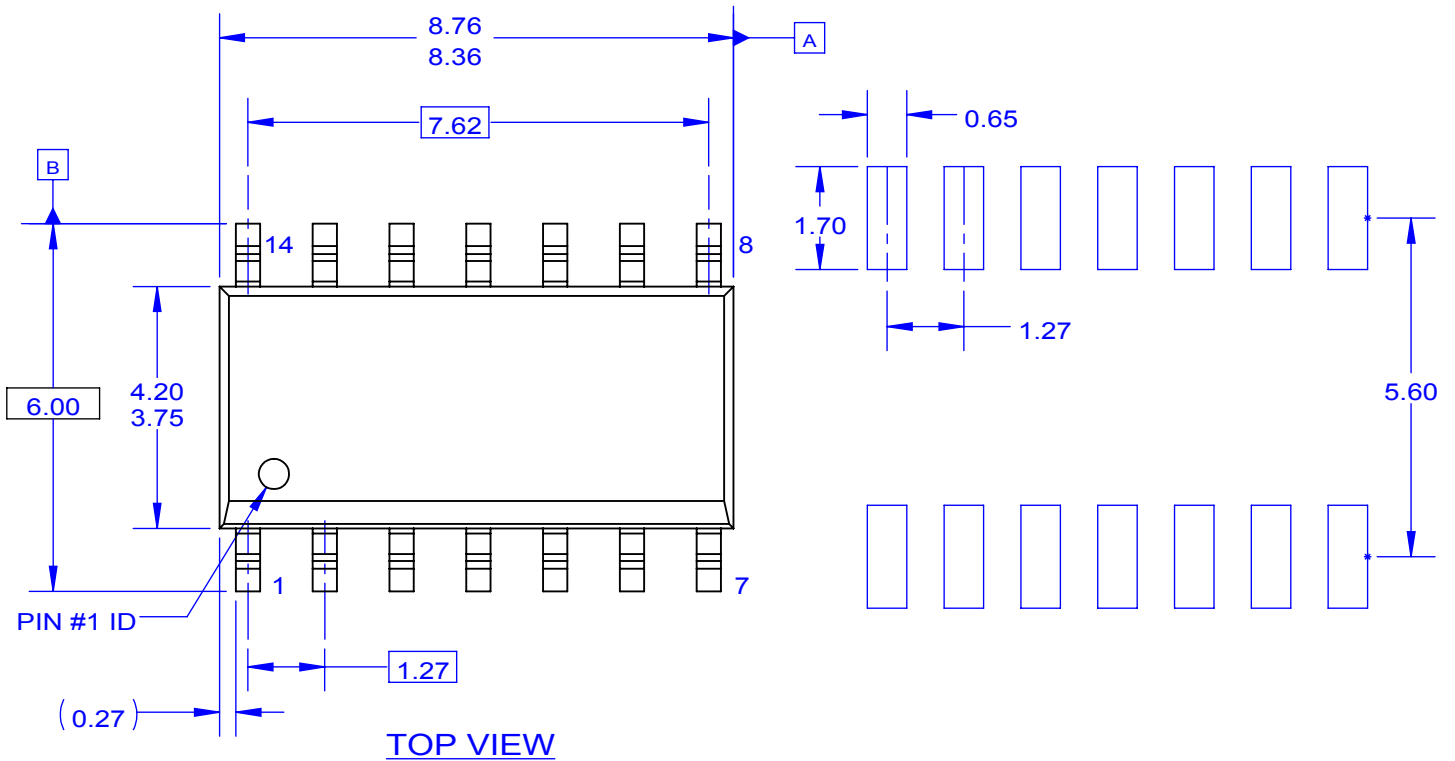

Figure 43. Delay Matching Waveform Definition



NOTES: UNLESS OTHERWISE SPECIFIED

A. THIS PACKAGE REFERENCE TO JEDEC MS-012 VARIATION AB.

B. ALL DIMENSIONS ARE IN MILLIMETERS.

C. DIMENSIONS ARE EXCLUSIVE OF BURRS, MOLD FLASH AND TIE BAR EXTRUSIONS.

D. DIMENSIONS AND TOLERANCES AS PER ASME Y14.5-1994.

E. OUT OF JEDEC STANDARD VALUE.

F. LAND PATTERN STANDARD: SOIC127P600X145-14M.

G. FILE NAME: MKT-M14C REV2

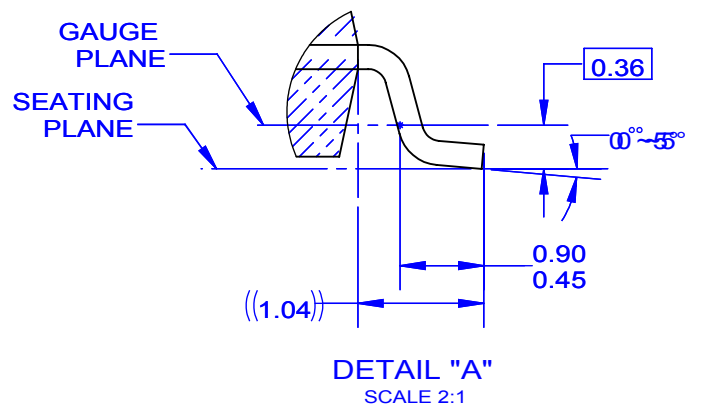



ON Semiconductor and  are trademarks of Semiconductor Components Industries, LLC dba ON Semiconductor or its subsidiaries in the United States and/or other countries. ON Semiconductor owns the rights to a number of patents, trademarks, copyrights, trade secrets, and other intellectual property. A listing of ON Semiconductor's product/patent coverage may be accessed at [www.onsemi.com/site/pdf/Patent-Marking.pdf](http://www.onsemi.com/site/pdf/Patent-Marking.pdf). ON Semiconductor reserves the right to make changes without further notice to any products herein. ON Semiconductor makes no warranty, representation or guarantee regarding the suitability of its products for any particular purpose, nor does ON Semiconductor assume any liability arising out of the application or use of any product or circuit, and specifically disclaims any and all liability, including without limitation special, consequential or incidental damages. Buyer is responsible for its products and applications using ON Semiconductor products, including compliance with all laws, regulations and safety requirements or standards, regardless of any support or applications information provided by ON Semiconductor. "Typical" parameters which may be provided in ON Semiconductor data sheets and/or specifications can and do vary in different applications and actual performance may vary over time. All operating parameters, including "Typicals" must be validated for each customer application by customer's technical experts. ON Semiconductor does not convey any license under its patent rights nor the rights of others. ON Semiconductor products are not designed, intended, or authorized for use as a critical component in life support systems or any FDA Class 3 medical devices or medical devices with a same or similar classification in a foreign jurisdiction or any devices intended for implantation in the human body. Should Buyer purchase or use ON Semiconductor products for any such unintended or unauthorized application, Buyer shall indemnify and hold ON Semiconductor and its officers, employees, subsidiaries, affiliates, and distributors harmless against all claims, costs, damages, and expenses, and reasonable attorney fees arising out of, directly or indirectly, any claim of personal injury or death associated with such unintended or unauthorized use, even if such claim alleges that ON Semiconductor was negligent regarding the design or manufacture of the part. ON Semiconductor is an Equal Opportunity/Affirmative Action Employer. This literature is subject to all applicable copyright laws and is not for resale in any manner.

## PUBLICATION ORDERING INFORMATION

### LITERATURE FULFILLMENT:

Literature Distribution Center for ON Semiconductor  
19521 E. 32nd Pkwy, Aurora, Colorado 80011 USA  
**Phone:** 303-675-2175 or 800-344-3860 Toll Free USA/Canada  
**Fax:** 303-675-2176 or 800-344-3867 Toll Free USA/Canada  
**Email:** [orderlit@onsemi.com](mailto:orderlit@onsemi.com)

**N. American Technical Support:** 800-282-9855 Toll Free  
USA/Canada  
**Europe, Middle East and Africa Technical Support:**  
Phone: 421 33 790 2910  
**Japan Customer Focus Center**  
Phone: 81-3-5817-1050

**ON Semiconductor Website:** [www.onsemi.com](http://www.onsemi.com)  
**Order Literature:** <http://www.onsemi.com/orderlit>  
For additional information, please contact your local  
Sales Representative

# Mouser Electronics

Authorized Distributor

Click to View Pricing, Inventory, Delivery & Lifecycle Information:

[ON Semiconductor:](#)

[FAN7393AM](#) [FAN7393AMX](#)

## Данный компонент на территории Российской Федерации

### Вы можете приобрести в компании MosChip.

Для оперативного оформления запроса Вам необходимо перейти по данной ссылке:

<http://moschip.ru/get-element>

Вы можете разместить у нас заказ для любого Вашего проекта, будь то серийное производство или разработка единичного прибора.

В нашем ассортименте представлены ведущие мировые производители активных и пассивных электронных компонентов.

Нашей специализацией является поставка электронной компонентной базы двойного назначения, продукции таких производителей как XILINX, Intel (ex.ALTERA), Vicor, Microchip, Texas Instruments, Analog Devices, Mini-Circuits, Amphenol, Glenair.

Сотрудничество с глобальными дистрибьюторами электронных компонентов, предоставляет возможность заказывать и получать с международных складов практически любой перечень компонентов в оптимальные для Вас сроки.

На всех этапах разработки и производства наши партнеры могут получить квалифицированную поддержку опытных инженеров.

Система менеджмента качества компании отвечает требованиям в соответствии с ГОСТ Р ИСО 9001, ГОСТ РВ 0015-002 и ЭС РД 009

### Офис по работе с юридическими лицами:

105318, г.Москва, ул.Щербаковская д.3, офис 1107, 1118, ДЦ «Щербаковский»

Телефон: +7 495 668-12-70 (многоканальный)

Факс: +7 495 668-12-70 (доб.304)

E-mail: [info@moschip.ru](mailto:info@moschip.ru)

Skype отдела продаж:

moschip.ru

moschip.ru\_4

moschip.ru\_6

moschip.ru\_9