

DC/DC regulator

Input 8.3 - 16 V
Output 16 A

Contents

| | |
|---|----|
| Product Program | 2 |
| Mechanical Data | 2 |
| Connections | 2 |
| Absolute Maximum Ratings | 3 |
| Input | 3 |
| Product Qualification Specification | 4 |
| Safety Specification | 5 |
| Adjusted to 1.0 Vout - Data | 6 |
| Adjusted to 1.2 Vout - Data | 9 |
| Adjusted to 1.5 Vout - Data | 12 |
| Adjusted to 1.8 Vout - Data | 15 |
| Adjusted to 2.5 Vout - Data | 18 |
| Adjusted to 3.3 Vout - Data | 21 |
| Adjusted to 5.0 Vout - Data | 24 |
| EMC Specification | 27 |
| Operating Information | 28 |
| Thermal Considerations | 30 |
| Soldering Information | 31 |
| Delivery Package Information | 32 |
| Compatibility with RoHS requirements | 32 |
| Reliability | 32 |
| Sales Offices and Contact Information | 33 |

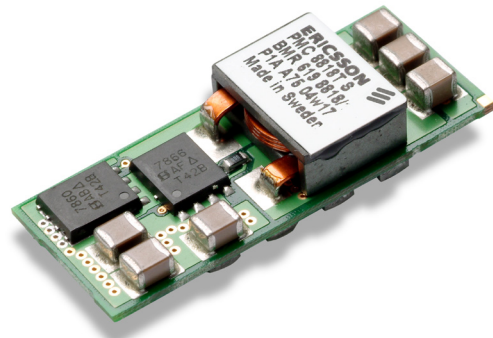

Key Features

- Wide input, 8.3 - 16 Vdc
- Programmable output, 0.75 - 5.5 Vdc
- Monotonic start up into pre-biased output
- Under voltage protection
- Short circuit protection
- Remote sense
- Remote On/Off
- Design for Environment (DfE)
- European Commission Directive 2002/95/EC (RoHs) compliant

The PMC series of surface mount DC/DC regulators (POL) are intended to be used as local distributed power sources in distributed power architecture. The high efficiency and high reliability of the PMC series makes them particularly suited for the communications equipment of today and tomorrow.

These products are manufactured using the most advanced technologies and materials to comply with en-

vironmental requirements. Designed to meet high reliability requirements of systems manufacturers, the PMC responds to world-class specifications.

Ericsson Power Modules is an ISO 9001/14001 certified supplier.

Product Program

| V _I | V _O /I _O max | P _O max | Ordering No. | Comment |
|-------------------------------|------------------------------------|--------------------|--------------|------------|
| | Output 1 | | | |
| 8.3 - 16V | 0.75 - 5.50/16 A | 80 W | PMC 8818T S | Released |
| 8.3 - 16V | 1.0 V/16 A | 16 W | PMC 8118NA S | On request |
| | 1.2 V/16 A | 19.2 W | PMC 8118LA S | On request |
| | 1.5 V/16 A | 24 W | PMC 8218H S | On request |
| | 1.8 V/10 A | 28.8 W | PMC 8218G S | On request |
| | 2.5 V/10 A | 40 W | PMC 8419 S | On request |
| | 3.3 V/16 A | 52.8 W | PMC 8510 S | On request |
| | 5 V/16 A | 80 W | PMC 8811 S | On request |
| Option | | Suffix | Example | |
| Negative Remote Control logic | | N | PMC 8818T SN | |

Mechanical Data

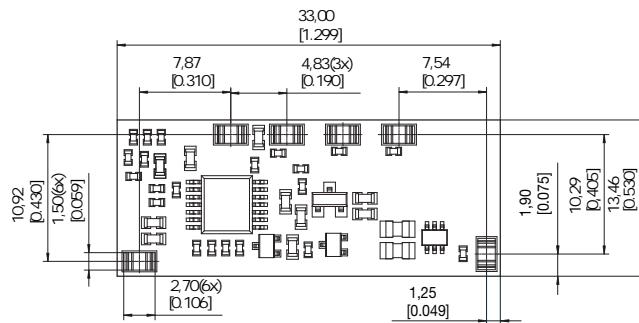

Bottom View

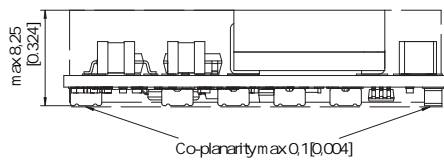

Dimensions in mm [inch]
 Tolerances (unless specified):
 x,xx ±0,25 [0,01]
 Pin true position \parallel it in 0,4 [0,016]

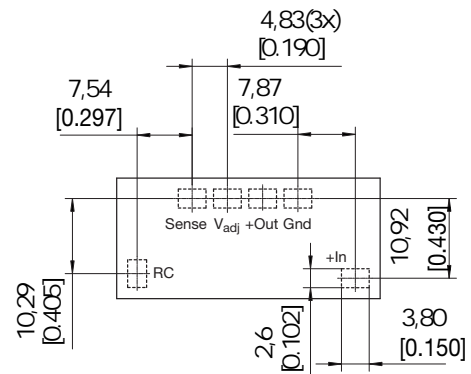
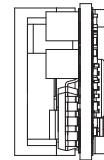

Recommended footprint.
 Top View

Connections

| Pin | Designation | Function |
|-----|-------------|-----------------------|
| 1 | RC | Remote Control |
| 2 | + In | Input Voltage |
| 3 | Gnd | Ground |
| 4 | + Out | Output Voltage |
| 5 | Vadj | Output Voltage Adjust |
| 6 | + S | Remote sensing |

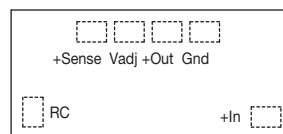

Weight

7 g

Pins

Material: Copper

Plating: Flash gold over nickel

Absolute Maximum Ratings

| Characteristics | | min | typ | max | Unit |
|-----------------|---|----------------|------|------|------|
| T_{ref} | Maximum Operating Temperature, see thermal considerations | -45 | | +115 | °C |
| T_S | Storage temperature | -55 | | +125 | °C |
| V_I | Input voltage | -0.3 | | 16 | Vdc |
| V_{tr} | Input voltage transient | -0.3 | | 40 | Vdc |
| V_{RC} | Remote control voltage | Negative logic | | 16 | Vdc |
| | | Positive logic | -0.3 | 16 | Vdc |

Stress in excess of Absolute Maximum Ratings may cause permanent damage. Absolute Maximum Ratings, sometimes referred to as no destruction limits, are normally tested with one parameter at a time exceeding the limits of Output data or Electrical Characteristics. If exposed to stress above these limits, function and performance may degrade in an unspecified manner.

Input

$T_{ref} = -30 \dots +90 \text{ °C}$, $V_I = 8.3 \dots 16.0 \text{ V}$ unless otherwise specified
 Typ values specified at: $T_{ref} = +25 \text{ °C}$, $V_{I,nom}$, $I_o,max = 16 \text{ A}$

| Characteristics | | Conditions | min | typ | max | Unit |
|-----------------|--|-------------------------------------|-----|------|------|-------------------|
| V_I | Input voltage range | | 8.3 | 12 | 16 | V |
| V_{loff} | Turn-off input voltage | I_o,max | | 7.8 | | V |
| V_{lon} | Turn-on input voltage | I_o,max | | 8.0 | | V |
| C_I | Input capacitance | | | 30 | | µF |
| P_{li} | Input idling power $I_o = 0 \text{ A}$, $V_I = 12 \text{ V}$ | $V_o = 1.00 \text{ V}$ | | 470 | 560 | mW |
| | | $V_o = 1.20 \text{ V}$ | | 500 | 600 | mW |
| | | $V_o = 1.50 \text{ V}$ | | 550 | 660 | mW |
| | | $V_o = 1.80 \text{ V}$ | | 605 | 725 | mW |
| | | $V_o = 2.50 \text{ V}$ | | 750 | 900 | mW |
| | | $V_o = 3.30 \text{ V}$ | | 910 | 1090 | mW |
| | | $V_o = 5.00 \text{ V}$ | | 1150 | 1410 | mW |
| P_{RC} | Input stand-by power | $V_I = 12 \text{ V}$, RC activated | | 35 | | mW |
| V_{iac} | Input ripple 1) 20 Hz ... 5 MHz $V_I = 12 \text{ V}$, $I_o = 1.0 \times I_o,max$ | $V_o = 1.00 \text{ V}$ | | 170 | | mV _{p-p} |
| | | $V_o = 1.20 \text{ V}$ | | 180 | | mV _{p-p} |
| | | $V_o = 1.50 \text{ V}$ | | 190 | | mV _{p-p} |
| | | $V_o = 1.80 \text{ V}$ | | 210 | | mV _{p-p} |
| | | $V_o = 2.50 \text{ V}$ | | 310 | | mV _{p-p} |
| | | $V_o = 3.30 \text{ V}$ | | 350 | | mV _{p-p} |
| | | $V_o = 5.00 \text{ V}$ | | 540 | | mV _{p-p} |

1) Measured with 4 x 4.7 µF ceramic capacitors

Fundamental Circuit Diagram

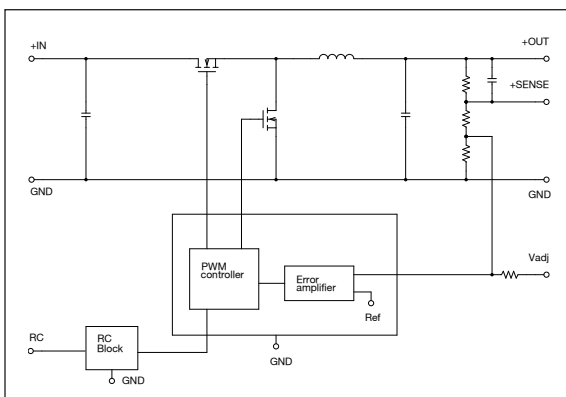

Absolute Maximum Ratings

| Characteristics | | min | typ | max | Unit |
|-----------------|---|------|-----|------|------|
| T_{ref} | Operating Reference Temperature, see pg. 27 | -45 | | +115 | °C |
| T_S | Storage temperature | -55 | | +125 | °C |
| V_I | Input voltage | -0.3 | | +5.5 | Vdc |

Stress in excess of Absolute Maximum Ratings may cause permanent damage. Absolute Maximum Ratings, sometimes referred to as no destruction limits, are normally tested with one parameter at a time exceeding the limits of Output data or Electrical Characteristics. If exposed to stress above these limits, function and performance may degrade in an unspecified manner.

Input $T_{ref} = -30 \dots +90 \text{ °C}$, $V_I = 3.0 \dots 5.5 \text{ V}$ unless otherwise specified
Typ values specified at: $T_{ref} = +25 \text{ °C}$, V_{Inom} , $I_{Omax} = 16 \text{ A}$

| Characteristics | | Conditions | min | typ | max | Unit |
|-----------------|----------------------------------|---|-----|-----|-----|------|
| V_I | Input voltage range | | 3.0 | | 5.5 | Vdc |
| V_{loff} | Turn-off input voltage | Ramp from higher voltage, $V_{out} = 1.0\text{-}2.5 \text{ V}$, $V_{in} = 3.3 \text{ V}$ | | 2.3 | | Vdc |
| | | Ramp from higher voltage, $V_{out} = 3.3 \text{ V}$, $V_{in} = 5.0 \text{ V}$ | | 3.4 | | |
| V_{lon} | Turn-on input voltage | Ramp from lower voltage, $V_{out} = 1.0\text{-}2.5 \text{ V}$, $V_{in} = 3.3 \text{ V}$ | | 2.4 | | Vdc |
| | | Ramp from lower voltage, $V_{out} = 3.3 \text{ V}$, $V_{in} = 5.0 \text{ V}$ | | 3.5 | | |
| C_I | Input capacitance | | | 20 | | μF |
| P_{li} | Input idling power | $I_O = 0 \text{ A}$, $V_I = 5.5 \text{ V}$ | | | 680 | mW |
| P_{RC} | Input stand-by power (RC active) | Non operation, $V_I = 5 \text{ V}$ | | | 7.5 | mW |
| V_{Iac} | Input ripple 1) | 20 Hz ... 5 MHz, I_{Omax} , $V_I = 5 \text{ V}$ | | 400 | | mV |

1) Measured with 2 x 22 μF ceramic capacitors

Fundamental Circuit Diagram

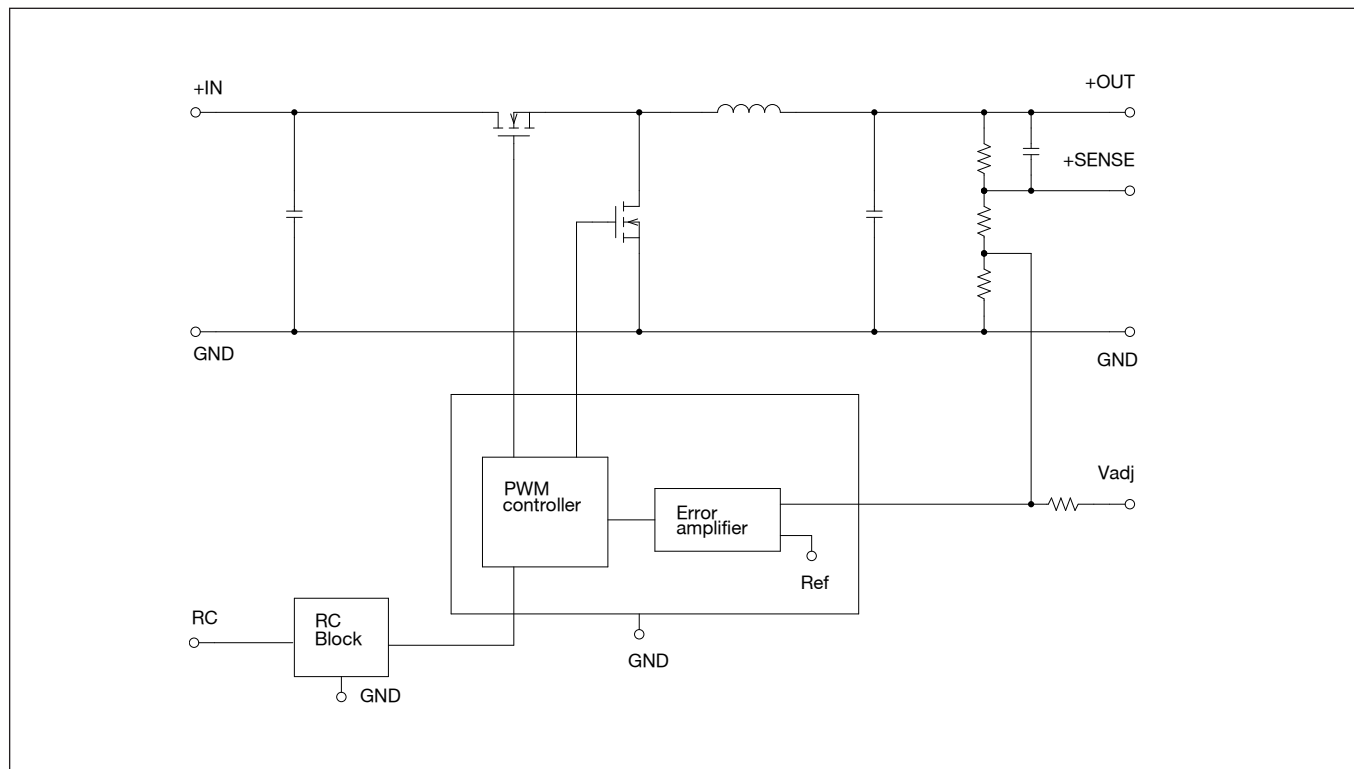

Product Qualification Specification

| Characteristics | | | |
|----------------------------------|--|--|--|
| Random Vibration | JESD 22-B103-B | Frequency Acceleration density | 2 ... 500 Hz 0.008 ... 0.2 g ² /Hz |
| Sinusoidal vibration | JESD 22-B103-B | Frequency Acceleration | 10 ... 1000 Hz 10 g |
| Mechanical shock (half sinus) | JESD 22-B104-B | Peak acceleration Duration | 200 g 1.5 ms |
| Lead integrity | JESD 22-B105-C | Weight of 1000 g | All terminals |
| Temperature cycling | JESD 22-A104-B | Temperature Number of cycles | -40 ... +125 °C 300 |
| Accelerated damp heat | JESD 22-A101-B | Temperature Humidity Duration Bias | +85 °C 85 % RH 1000 hours max input voltage |
| Solderability | IEC 60068-2-54 (Aged according to JESD 22-A101-B, 240h no bias) | Solder immersion depth Time for onset of wetting Wetting force | 1 mm < 4 s > 100 mN/m |
| Cold (in operation) | IEC 60068-2-1A, test A _d | Temperature Duration | -45 °C 72 h |
| High temperature storage | JESD 22-A103-B | Temperature Duration | +125 °C 1000 h |

Safety Specification

General information.

Ericsson Power Modules DC/DC converters and DC/DC regulators are designed in accordance with safety standards IEC/EN/UL 60 950, *Safety of Information Technology Equipment*.

IEC/EN/UL60950 contains requirements to prevent injury or damage due to the following hazards:

- *Electrical shock*
- *Energy hazards*
- *Fire*
- *Mechanical and heat hazards*
- *Radiation hazards*
- *Chemical hazards*

On-board DC-DC converters are defined as component power supplies. As components they cannot fully comply with the provisions of any Safety requirements without "Conditions of Acceptability". It is the responsibility of the installer to ensure that the final product housing these components complies with the requirements of all applicable Safety standards and Directives for the final product.

Component power supplies for general use should comply with the requirements in IEC60950, EN60950 and UL60950 "Safety of information technology equipment".

There are other more product related standards, e.g. IEC61204-7 "Safety standard for power supplies", IEEE802.3af "Ethernet LAN/MAN Data terminal equipment power", and ETS300132-2 "Power supply interface at the input to telecommunications equipment; part 2: DC", but all of these standards are based on IEC/EN/UL60950 with regards to safety.

Ericsson Power Modules DC/DC converters and DC/DC regulators are UL 60 950 recognized and certified in accordance with EN 60 950.

The flammability rating for all construction parts of the products meets UL 94V-0.

The products should be installed in the end-use equipment, in accordance with the requirements of the ultimate application. Normally the output of the DC/DC converter is considered as SELV (Safety Extra Low Voltage) and the input source must be isolated by minimum Double or Reinforced Insulation from the primary circuit (AC mains) in accordance with IEC/EN/UL 60 950.

Isolated DC/DC converters.

It is recommended that a fast blow fuse with a rating twice the maximum input current per selected product be used at the input of each DC/DC converter. If an input filter is used in the circuit the fuse should be placed in front of the input filter.

In the rare event of a component problem in the input filter or in the DC/DC converter that imposes a short circuit on the input source, this fuse will provide the following functions:

- Isolate the faulty DC/DC converter from the input power source so as not to affect the operation of other parts of the system.
- Protect the distribution wiring from excessive current and power loss thus preventing hazardous overheating.

The galvanic isolation is verified in an electric strength test. The test voltage (V_{ISO}) between input and output is 1500 Vdc or 2250 Vdc for 60 seconds (refer to product specification). Leakage current is less than 1 μ A at nominal input voltage.

24 V dc systems.

The input voltage to the DC/DC converter is SELV (Safety Extra Low Voltage) and the output remains SELV under normal and abnormal operating conditions.

48 and 60 V dc systems.

If the input voltage to Ericsson Power Modules DC/DC converter is 75 V dc or less, then the output remains SELV (Safety Extra Low Voltage) under normal and abnormal operating conditions.

Single fault testing in the input power supply circuit should be performed with the DC/DC converter connected to demonstrate that the input voltage does not exceed 75 V dc.

If the input power source circuit is a DC power system, the source may be treated as a TNV2 circuit and testing has demonstrated compliance with SELV limits and isolation requirements equivalent to Basic Insulation in accordance with IEC/EN/UL 60 950.

Non-isolated DC/DC regulators.

The input voltage to the DC/DC regulator is SELV (Safety Extra Low Voltage) and the output remains SELV under normal and abnormal operating conditions.

It is recommended that a slow blow fuse with a rating twice the maximum input current per selected product be used at the input of each DC/DC regulator.

Adjusted to 1.0 Vout - Data

$T_{ref} = -30 \dots +90 \text{ }^\circ\text{C}$, $V_I = 8.3 \dots 16 \text{ V}$ unless otherwise specified. Input filter $4 \times 4.7 \text{ } \mu\text{F}$, Output filter $2 \times 150 \text{ } \mu\text{F}$
 Typ values specified at: $T_{ref} = +25 \text{ }^\circ\text{C}$ and V_{Inom} , $I_{Omax} = 16 \text{ A}$. Note: +Sense connected to +Out. $R_{adj} 41.42 \text{ k}\Omega$

| Characteristics | | Conditions | Output | | | Unit |
|-----------------|--|---|--------|-----------|-----|----------------------------|
| | | | min | typ | max | |
| dV_{O_i} | Output voltage adjusted setting | $T_{ref} = +25 \text{ }^\circ\text{C}$, V_{Inom} , I_{Omax} | -2 | | +2 | % V_O |
| dV_O | Output voltage tolerance band | $I_O = 0.01 \dots 1.0 \times I_{Omax}$ | -3 | | +3 | % V_O |
| dV_O | Idling voltage | $I_O = 0 \text{ A}$ | -2 | | +2 | % V_O |
| dV_O | Line regulation | $V_{Imin} \dots V_{Imax}$, I_{Omax} | | 2 | | mV |
| dV_O | Load regulation | $I_O = 0.01 \dots 1.0 \times I_{Omax}$ | | 25 | | mV |
| t_{tr} | Load transient recovery time | Load step = $0.25\text{-}0.75\text{-}0.25 \times I_{Omax}$, $dI/dt = 5 \text{ A}/\mu\text{s}$, $C_O = 2 \times 150 \text{ } \mu\text{F}$, $V_I = 12 \text{ V}$ | | 40 | | μs |
| V_{tr} | Load transient voltage | $V_I = 12 \text{ V}$ | | ± 100 | | mV |
| T_{coeff} | Temperature coefficient | $T_{ref} = -30 \dots +90 \text{ }^\circ\text{C}$, I_{Omax} | | -0.6 | | $\text{mV}/^\circ\text{C}$ |
| t_s | Start-up V_I on to $0.9 \times V_O$ | $I_O = I_{Omax}$, V_{Inom} | | 7 | | ms |
| t_r | Ramp-up, $V_I \dots 0.9 \times V_O$ | $I_O = I_{Omax}$, V_{Inom} | | 3 | | ms |
| t_f | Fall time, V_I to $0.1 \times V_O$ | $I_O = I_{Omax}$, V_{Inom} | | 1 | | ms |
| t_f | Fall time, V_I to $0.1 \times V_O$ | $I_O = 0 \text{ A}$, V_{Inom} | | 22 | | s |
| t_{RC} | RC shut-down time $0.1 \times V_O$ | $I_O = I_{Omax}$, V_{Inom} | | 1 | | ms |
| t_{RC} | RC start-up time $0.9 \times V_O$ | $I_O = I_{Omax}$, V_{Inom} | | 7 | | ms |
| t_{RC} | RC fall time, $0.1 \times V_O$ | $I_O = 0 \text{ A}$, V_{Inom} | | 24 | | s |
| I_O | Output current | | 0 | | 16 | A |
| P_{Omax} | Max output power | | 16 | | | W |
| I_{lim} | Current limiting threshold | $T_{ref} < T_{refmax}$ | 19 | | | A |
| V_{Oac} | Output ripple | 20 Hz ... 5 MHz, I_{Omax} | | 50 | | mV_{p-p} |
| η | Efficiency - 50% load | $I_O = 0.5 \times I_{Omax}$, $V_O = 1.00 \text{ V}$ | | 84.4 | | % |
| η | Efficiency - 100% load | $I_O = I_{Omax}$, $V_O = 1.00 \text{ V}$ | 80.8 | 83.2 | | % |
| P_d | Power Dissipation | $I_O = I_{Omax}$, $V_O = 1.00 \text{ V}$ | | 3.2 | 3.8 | W |
| F_o | Switching frequency | $I_O = (0 \dots 1) \times I_{Omax}$ | 260 | 300 | 340 | kHz |
| I_{sense} | Remote sense current | | | | 10 | mA |
| I_I | Static input current $V_I = 8.3 \text{ V}$ | $I_O = I_{Omax}$, $V_O = 1.00 \text{ V}$ | | 2.4 | | A |
| MTBF | Predicted reliability | | | 5 | | million hours |

Adjusted to 1.0 Vout - Typical Characteristics

General conditions: Input filter 4 x 4.7 μ F, Output filter 2 x 150 μ F

Efficiency

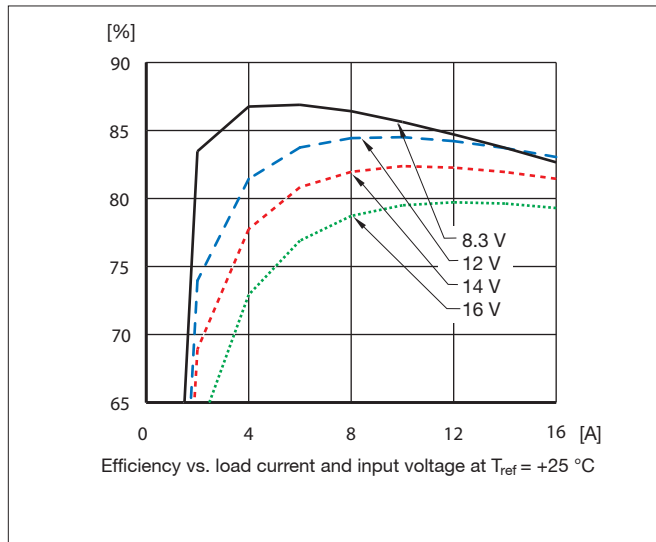

Power Dissipation

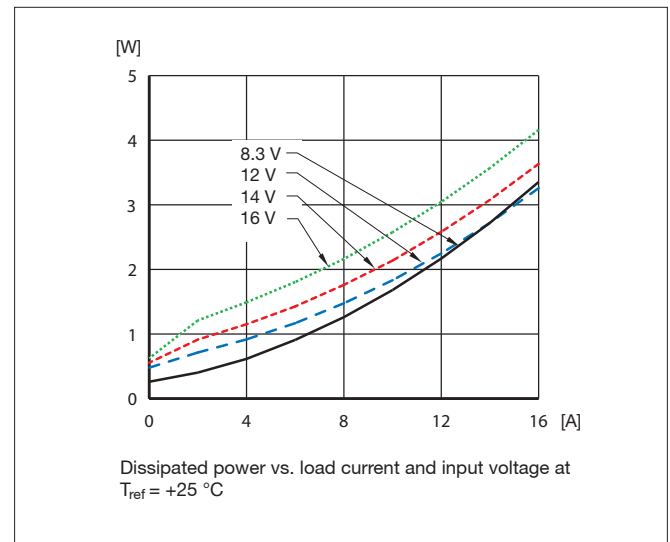

Output Current Derating at 12 V input

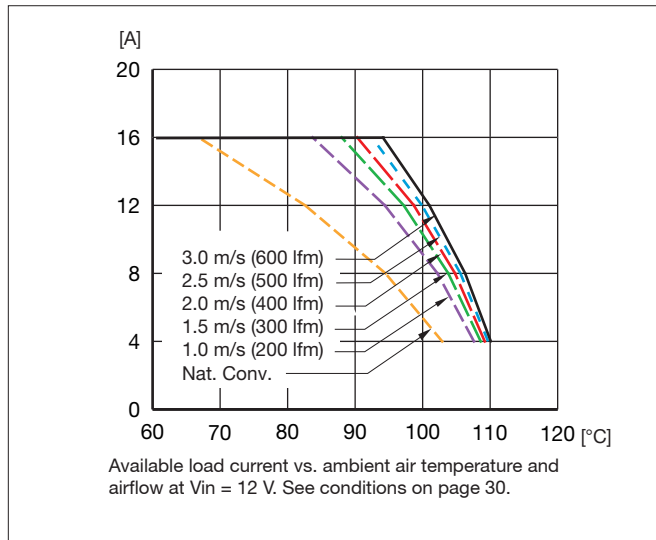

Output Characteristics

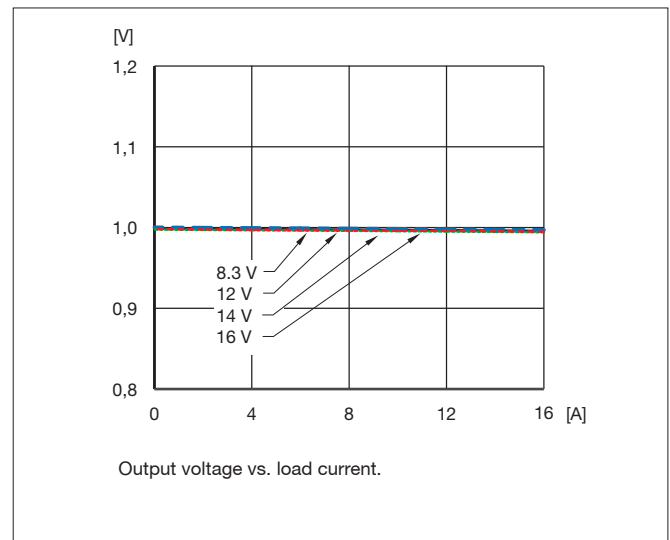

Start-Up

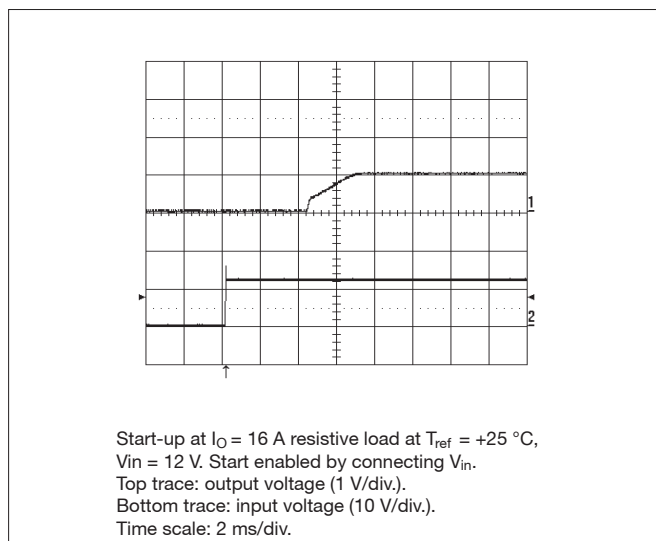

Turn Off

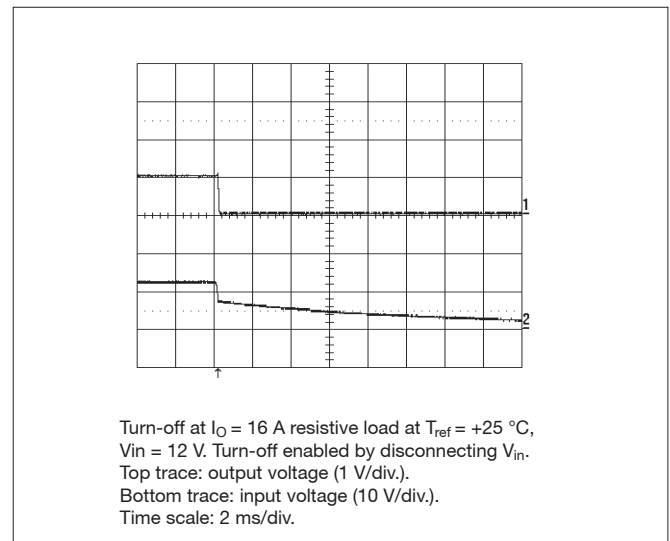

Adjusted to 1.0 Vout - Typical Characteristics

General conditions: Input filter 4 x 4.7 μF , Output filter 2 x 150 μF

Output Ripple

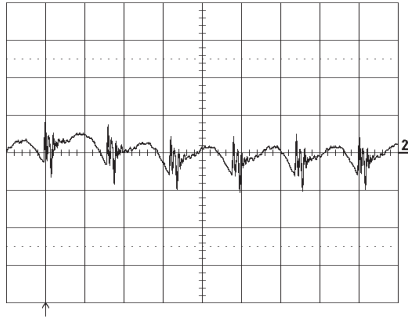

Output voltage ripple (20 mV/div.) at $T_{\text{ref}} = +25\text{ }^{\circ}\text{C}$,
 $V_{\text{in}} = 12\text{ V}$, $I_{\text{O}} = 16\text{ A}$ resistive load.
Band width = 5 MHz.
Time scale: 2 $\mu\text{s}/\text{div}$.

Transient

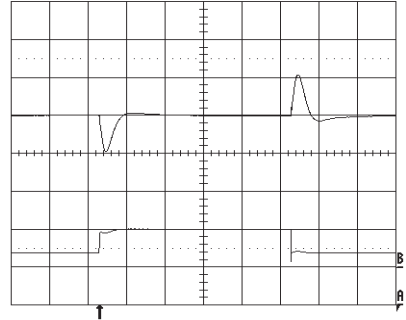

Output voltage response to load current step-change
(4-12-4 A) at $T_{\text{ref}} = +25\text{ }^{\circ}\text{C}$, $V_{\text{in}} = 12\text{ V}$. $dI/dt = 5\text{ A}/\mu\text{s}$
Top trace: output voltage (ac) (100 mV/div.).
Bottom trace: load current (dc) (10 A/div.)
Time scale: 0.1 ms/div.

Adjusted to 1.2 Vout - Data

$T_{ref} = -30 \dots +90 \text{ }^\circ\text{C}$, $V_I = 8.3 \dots 16 \text{ V}$ unless otherwise specified. Input filter $4 \times 4.7 \text{ } \mu\text{F}$, Output filter $2 \times 150 \text{ } \mu\text{F}$
 Typ values specified at: $T_{ref} = +25 \text{ }^\circ\text{C}$ and V_{Inom} , $I_{Omax} = 16 \text{ A}$. Note: +Sense connected to +Out. $R_{adj} 22.46 \text{ k}\Omega$

| Characteristics | | Conditions | Output | | | Unit |
|-----------------|--|---|--------|-----------|-----|----------------------------|
| | | | min | typ | max | |
| dV_{O_i} | Output voltage adjusted setting | $T_{ref} = +25 \text{ }^\circ\text{C}$, V_{Inom} , I_{Omax} | -2 | | +2 | % V_O |
| dV_O | Output voltage tolerance band | $I_O = 0.01 \dots 1.0 \times I_{Omax}$ | -3 | | +3 | % V_O |
| dV_O | Idling voltage | $I_O = 0 \text{ A}$ | -2 | | +2 | % V_O |
| dV_O | Line regulation | $V_{Imin} \dots V_{Imax}$, I_{Omax} | | 2 | | mV |
| dV_O | Load regulation | $I_O = 0.01 \dots 1.0 \times I_{Omax}$ | | 25 | | mV |
| t_{tr} | Load transient recovery time | Load step = $0.25-0.75-0.25 \times I_{Omax}$, $dI/dt = 5 \text{ A}/\mu\text{s}$, $C_O = 2 \times 150 \text{ } \mu\text{F}$, $V_I = 12 \text{ V}$ | | 40 | | μs |
| V_{tr} | Load transient voltage | $V_I = 12 \text{ V}$ | | ± 100 | | mV |
| T_{coeff} | Temperature coefficient | $T_{ref} = -30 \dots +90 \text{ }^\circ\text{C}$, I_{Omax} | | -0.6 | | $\text{mV}/^\circ\text{C}$ |
| t_s | Start-up V_I on to $0.9 \times V_O$ | $I_O = I_{Omax}$, V_{Inom} | | 7 | | ms |
| t_r | Ramp-up, $V_I \dots 0.9 \times V_O$ | $I_O = I_{Omax}$, V_{Inom} | | 3 | | ms |
| t_f | Fall time, V_I to $0.1 \times V_O$ | $I_O = I_{Omax}$, V_{Inom} | | 1 | | ms |
| t_f | Fall time, V_I to $0.1 \times V_O$ | $I_O = 0 \text{ A}$, V_{Inom} | | 21 | | s |
| t_{RC} | RC shut-down time $0.1 \times V_O$ | $I_O = I_{Omax}$, V_{Inom} | | 1 | | ms |
| t_{RC} | RC start-up time $0.9 \times V_O$ | $I_O = I_{Omax}$, V_{Inom} | | 7 | | ms |
| t_{RC} | RC fall time, $0.1 \times V_O$ | $I_O = 0 \text{ A}$, V_{Inom} | | 21 | | s |
| I_O | Output current | | 0 | | 16 | A |
| P_{Omax} | Max output power | | 19.2 | | | W |
| I_{lim} | Current limiting threshold | $T_{ref} < T_{refmax}$ | 19 | | | A |
| V_{Oac} | Output ripple | 20 Hz ... 5 MHz, I_{Omax} | | 50 | | mV_{p-p} |
| η | Efficiency - 50% load | $I_O = 0.5 \times I_{Omax}$, $V_O = 1.20 \text{ V}$ | | 86.5 | | % |
| η | Efficiency - 100% load | $I_O = I_{Omax}$, $V_O = 1.20 \text{ V}$ | 81.5 | 85.4 | | % |
| P_d | Power Dissipation | $I_O = I_{Omax}$, $V_O = 1.20 \text{ V}$ | | 3.3 | 4.4 | W |
| F_o | Switching frequency | $I_O = (0 \dots 1) \times I_{Omax}$ | 260 | 300 | 340 | kHz |
| I_{sense} | Remote sense current | | | | 10 | mA |
| I_I | Static input current $V_I = 8.3 \text{ V}$ | $I_O = I_{Omax}$, $V_O = 1.20 \text{ V}$ | | 2.8 | | A |
| MTBF | Predicted reliability | | | 5 | | million hours |

Adjusted to 1.2 Vout - Typical Characteristics

General conditions: Input filter 4 x 4.7 μ F, Output filter 2 x 150 μ F

Efficiency

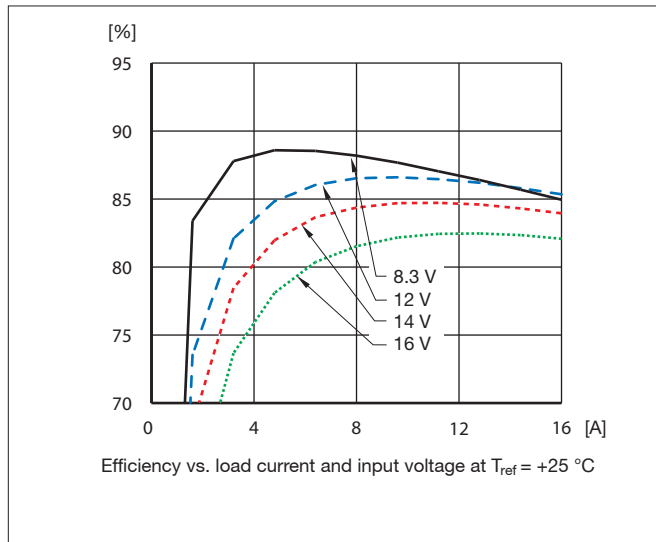

Power Dissipation

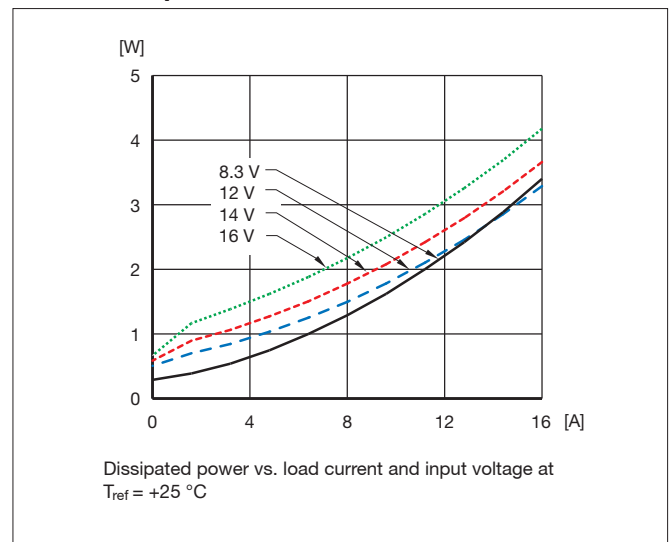

Output Current Derating at 12 V input

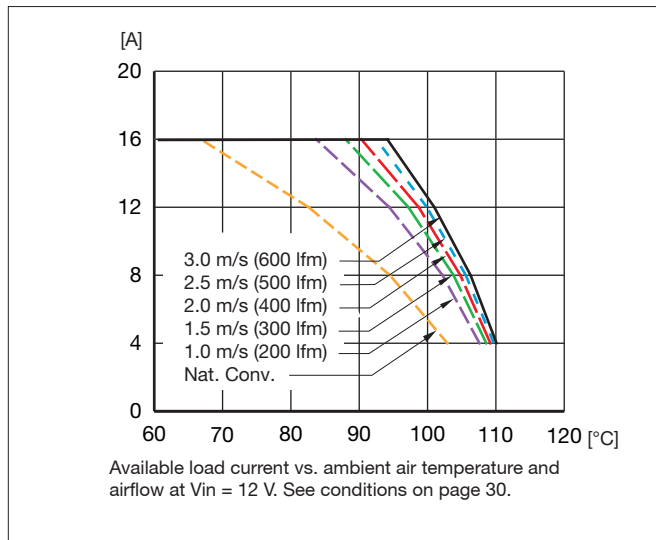

Output Characteristic

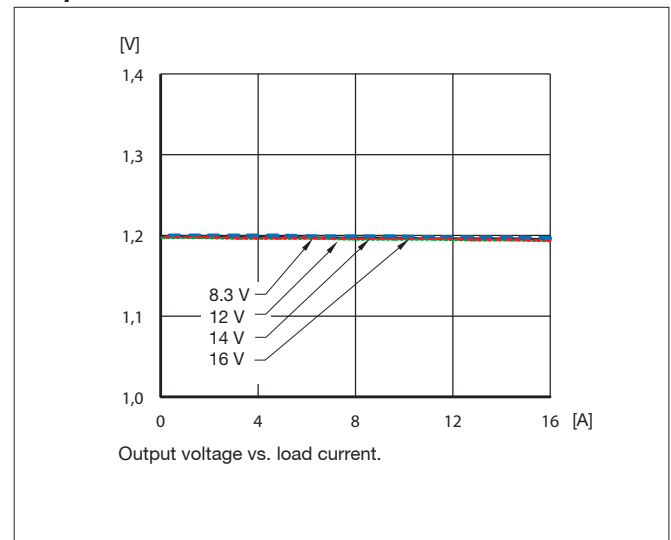

Start-Up

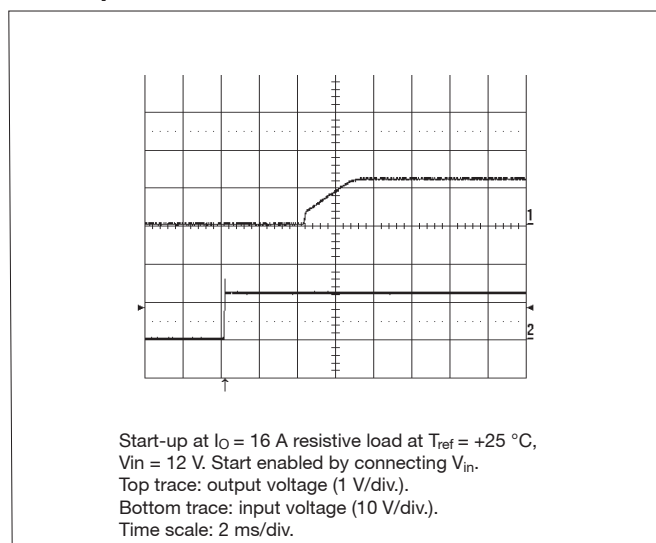

Turn Off

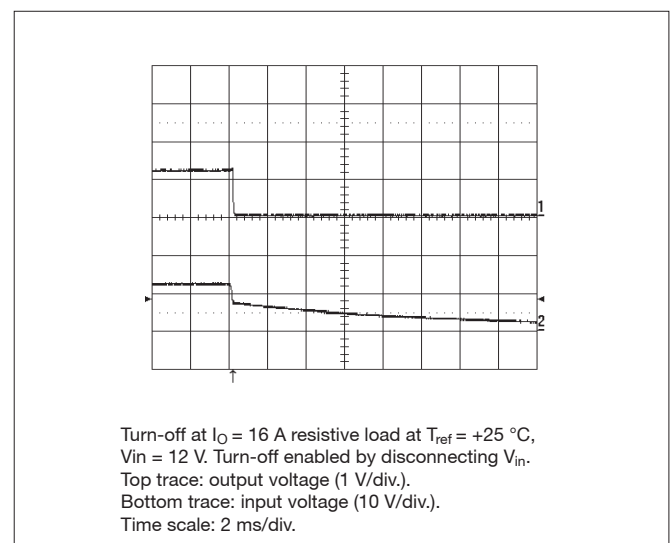

Adjusted to 1.2 Vout - Typical Characteristics

General conditions: Input filter 4 x 4.7 μ F, Output filter 2 x 150 μ F

Output Ripple

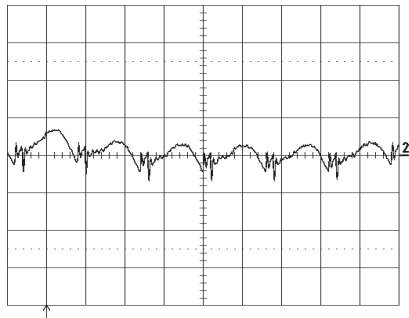

Output voltage ripple (20 mV/div.) at $T_{ref} = +25\text{ }^{\circ}\text{C}$,
 $V_{in} = 12\text{ V}$, $I_O = 16\text{ A}$ resistive load.
Band width = 5 MHz.
Time scale: 2 μ s/div.

Transient

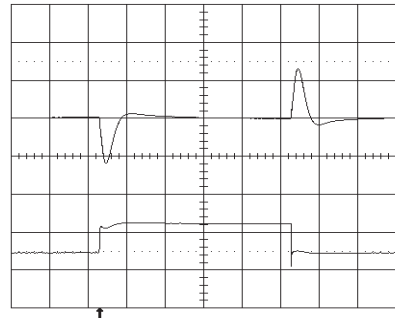

Output voltage response to load current step-change
(4-12-4 A) at $T_{ref} = +25\text{ }^{\circ}\text{C}$, $V_{in} = 12\text{ V}$. $di/dt = 5\text{ A}/\mu\text{s}$
Top trace: output voltage (ac) (100 mV/div.).
Bottom trace: load current (dc) (10 A/div.)
Time scale: 0.1 ms/div.

Adjusted to 1.5 Vout - Data

$T_{ref} = -30 \dots +90 \text{ }^\circ\text{C}$, $V_I = 8.3 \dots 16 \text{ V}$ unless otherwise specified. Input filter $4 \times 4.7 \text{ } \mu\text{F}$, Output filter $2 \times 150 \text{ } \mu\text{F}$
Typ values specified at: $T_{ref} = +25 \text{ }^\circ\text{C}$ and V_{Inom} . $I_{Omax} = 16 \text{ A}$. Note: +Sense connected to +Out. $R_{adj} 13.05 \text{ k}\Omega$

| Characteristics | | Conditions | Output | | | Unit |
|-----------------|--|---|--------|-----------|-----|----------------------------|
| | | | min | typ | max | |
| dV_{O_i} | Output voltage adjusted setting | $T_{ref} = +25 \text{ }^\circ\text{C}$, V_{Inom} , I_{Omax} | -2 | | +2 | % V_O |
| dV_O | Output voltage tolerance band | $I_O = 0.01 \dots 1.0 \times I_{Omax}$ | -3 | | +3 | % V_O |
| dV_O | Idling voltage | $I_O = 0 \text{ A}$ | -2 | | +2 | % V_O |
| dV_O | Line regulation | $V_{Imin} \dots V_{Imax}$, I_{Omax} | | 2 | | mV |
| dV_O | Load regulation | $I_O = 0.01 \dots 1.0 \times I_{Omax}$ | | 25 | | mV |
| t_{tr} | Load transient recovery time | Load step = $0.25-0.75-0.25 \times I_{Omax}$, $dI/dt = 5 \text{ A}/\mu\text{s}$, $C_O = 2 \times 150 \text{ } \mu\text{F}$, $V_I = 12 \text{ V}$ | | 40 | | μs |
| V_{tr} | Load transient voltage | $V_I = 12 \text{ V}$ | | ± 100 | | mV |
| T_{coeff} | Temperature coefficient | $T_{ref} = -30 \dots +90 \text{ }^\circ\text{C}$, I_{Omax} | | -0.6 | | $\text{mV}/^\circ\text{C}$ |
| t_s | Start-up V_I on to $0.9 \times V_O$ | $I_O = I_{Omax}$, V_{Inom} | | 7 | | ms |
| t_r | Ramp-up, $V_I \dots 0.9 \times V_O$ | $I_O = I_{Omax}$, V_{Inom} | | 3 | | ms |
| t_f | Fall time, V_I to $0.1 \times V_O$ | $I_O = I_{Omax}$, V_{Inom} | | 1 | | ms |
| t_f | Fall time, V_I to $0.1 \times V_O$ | $I_O = 0 \text{ A}$, V_{Inom} | | 20 | | s |
| t_{RC} | RC shut-down time $0.1 \times V_O$ | $I_O = I_{Omax}$, V_{Inom} | | 1 | | ms |
| t_{RC} | RC start-up time $0.9 \times V_O$ | $I_O = I_{Omax}$, V_{Inom} | | 7 | | ms |
| t_{RC} | RC fall time, $0.1 \times V_O$ | $I_O = 0 \text{ A}$, V_{Inom} | | 20 | | s |
| I_O | Output current | | 0 | | 16 | A |
| P_{Omax} | Max output power | | 24 | | | W |
| I_{lim} | Current limiting threshold | $T_{ref} < T_{refmax}$ | 19 | | | A |
| V_{Oac} | Output ripple | 20 Hz ... 5 MHz, I_{Omax} | | 50 | | mV_{p-p} |
| η | Efficiency - 50% load | $I_O = 0.5 \times I_{Omax}$, $V_O = 1.50 \text{ V}$ | | 88.5 | | % |
| η | Efficiency - 100% load | $I_O = I_{Omax}$, $V_O = 1.50 \text{ V}$ | 84.2 | 87.6 | | % |
| P_d | Power Dissipation | $I_O = I_{Omax}$, $V_O = 1.50 \text{ V}$ | | 3.4 | 4.5 | W |
| F_o | Switching frequency | $I_O = (0 \dots 1) \times I_{Omax}$ | 260 | 300 | 340 | kHz |
| I_{sense} | Remote sense current | | | | 10 | mA |
| I_i | Static input current $V_I = 8.3 \text{ V}$ | $I_O = I_{Omax}$, $V_O = 1.50 \text{ V}$ | | 3.4 | | A |
| MTBF | Predicted reliability | | | 5 | | million hours |

Adjusted to 1.5 Vout - Typical Characteristics

General conditions: Input filter 4 x 4.7 μ F, Output filter 2 x 150 μ F

Efficiency

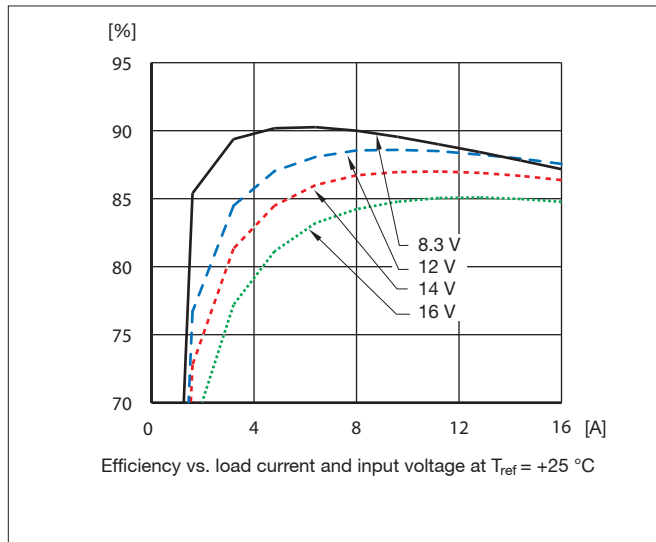

Power Dissipation

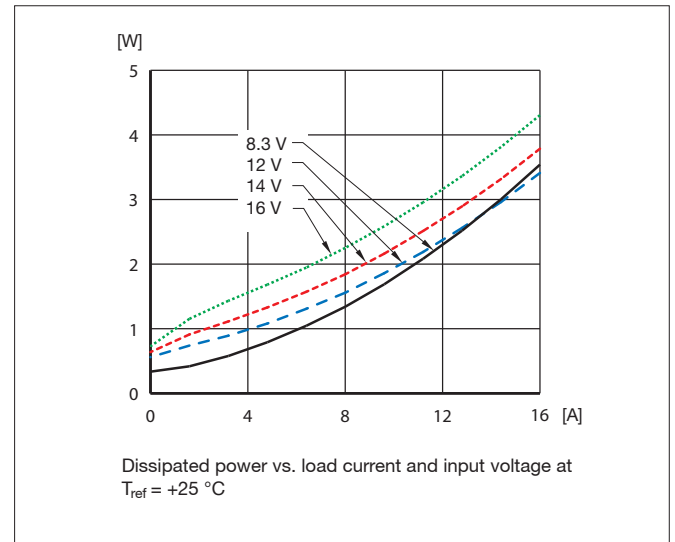

Output Current Derating at 12 V input

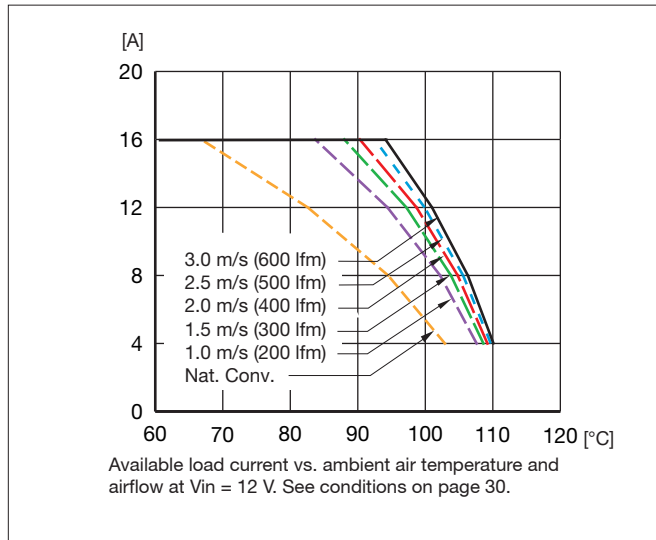

Output Characteristic

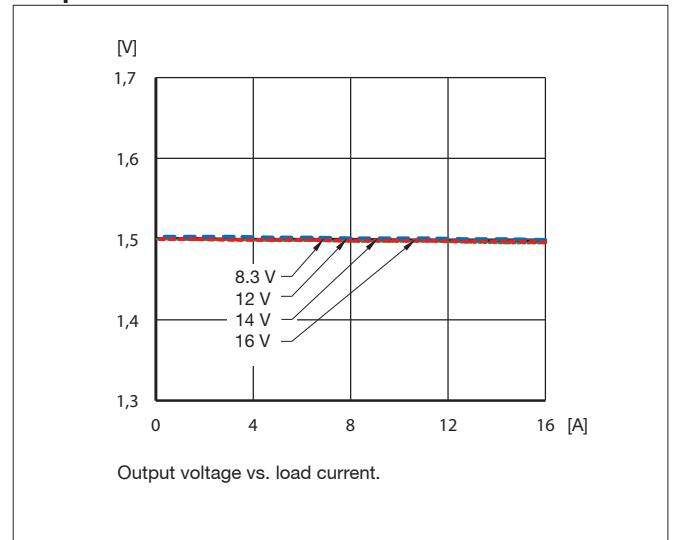

Start-Up

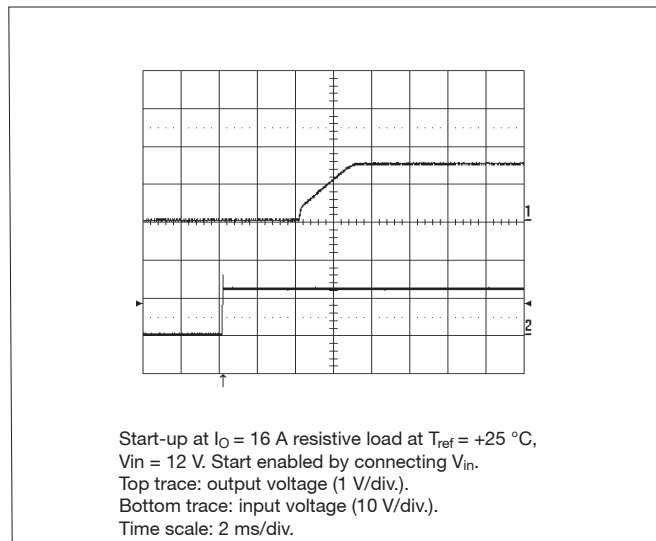

Turn Off

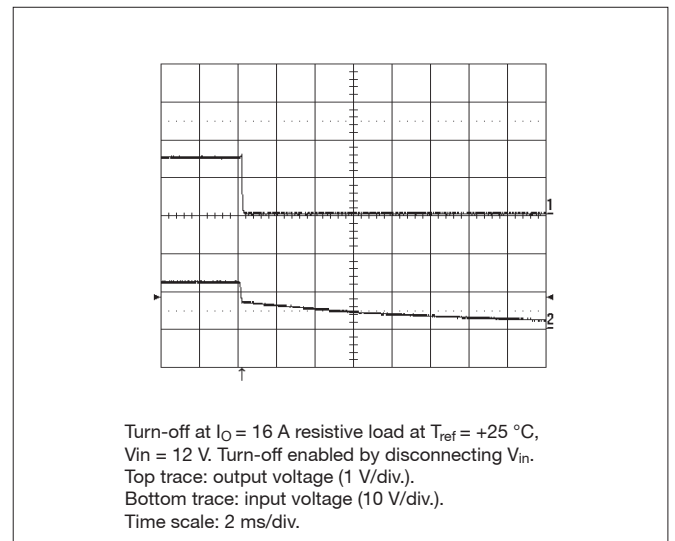

Adjusted to 1.5 Vout - Typical Characteristics

General conditions: Input filter 4 x 4.7 μ F, Output filter 2 x 150 μ F

Output Ripple

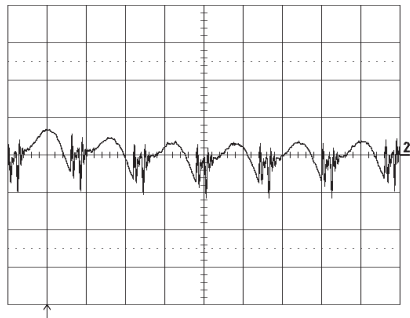

Output voltage ripple (20 mV/div.) at $T_{ref} = +25\text{ }^{\circ}\text{C}$,
 $V_{in} = 12\text{ V}$, $I_O = 16\text{ A}$ resistive load.
Band width = 5 MHz.
Time scale: 2 μ s/div.

Transient

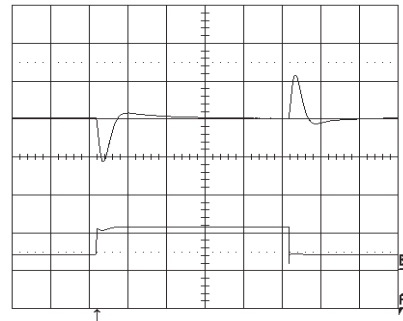

Output voltage response to load current step-change
(4-12-4 A) at $T_{ref} = +25\text{ }^{\circ}\text{C}$, $V_{in} = 12\text{ V}$. $dI/dt = 5\text{ A}/\mu\text{s}$
Top trace: output voltage (ac) (100 mV/div.).
Bottom trace: load current (dc) (10 A/div.)
Time scale: 0.1 ms/div.

Adjusted to 1.8 Vout - Data

$T_{ref} = -30...+90\text{ }^{\circ}\text{C}$, $V_I = 8.3 \dots 16\text{ V}$ unless otherwise specified. Input filter $4 \times 4.7\text{ }\mu\text{F}$, Output filter $2 \times 150\text{ }\mu\text{F}$
Typ values specified at: $T_{ref} = +25\text{ }^{\circ}\text{C}$ and V_{Inom} . $I_{Omax} = 16\text{ A}$. Note: +Sense connected to +Out. $R_{adj} 9.024\text{ k}\Omega$

| Characteristics | | Conditions | Output | | | Unit |
|-----------------|---|---|--------|-----------|-----|------------------------|
| | | | min | typ | max | |
| dV_{Oi} | Output voltage adjusted setting | $T_{ref} = +25\text{ }^{\circ}\text{C}$, V_{Inom} , I_{Omax} | -2 | | +2 | % V_O |
| dV_O | Output voltage tolerance band | $I_O = 0.01...1.0 \times I_{Omax}$ | -3 | | +3 | % V_O |
| dV_O | Idling voltage | $I_O = 0\text{ A}$ | -2 | | +2 | % V_O |
| dV_O | Line regulation | $V_{Imin} \dots V_{Imax}$, I_{Omax} | | 2 | | mV |
| dV_O | Load regulation | $I_O = 0.01...1.0 \times I_{Omax}$ | | 25 | | mV |
| t_{tr} | Load transient recovery time | Load step = $0.25\text{-}0.75\text{-}0.25 \times I_{Omax}$, $di/dt = 5\text{ A}/\mu\text{s}$, $C_O = 2 \times 150\text{ }\mu\text{F}$, $V_I = 12\text{ V}$ | | 40 | | μs |
| V_{tr} | Load transient voltage | $V_I = 12\text{ V}$ | | ± 100 | | mV |
| T_{coeff} | Temperature coefficient | $T_{ref} = -30 \dots +90\text{ }^{\circ}\text{C}$, I_{Omax} | | -0.6 | | mV/ $^{\circ}\text{C}$ |
| t_s | Start-up V_I on to $0.9 \times V_O$ | $I_O = I_{Omax}$, V_{Inom} | | 7 | | ms |
| t_r | Ramp-up, $V_I \dots 0.9 \times V_O$ | $I_O = I_{Omax}$, V_{Inom} | | 3 | | ms |
| t_f | Fall time, V_I to $0.1 \times V_O$ | $I_O = I_{Omax}$, V_{Inom} | | 1 | | ms |
| t_f | Fall time, V_I to $0.1 \times V_O$ | $I_O = 0\text{ A}$, V_{Inom} | | 18 | | s |
| t_{RC} | RC shut-down time $0.1 \times V_O$ | $I_O = I_{Omax}$, V_{Inom} | | 1 | | ms |
| t_{RC} | RC start-up time $0.9 \times V_O$ | $I_O = I_{Omax}$, V_{Inom} | | 7 | | ms |
| t_{RC} | RC fall time, $0.1 \times V_O$ | $I_O = 0\text{ A}$, V_{Inom} | | 18 | | s |
| I_O | Output current | | 0 | | 16 | A |
| P_{Omax} | Max output power | | 28.8 | | | W |
| I_{lim} | Current limiting threshold | $T_{ref} < T_{refmax}$ | 19 | | | A |
| V_{Oac} | Output ripple | 20 Hz ... 5 MHz, I_{Omax} | | 50 | | mV _{p-p} |
| η | Efficiency - 50% load | $I_O = 0.5 \times I_{Omax}$, $V_O = 1.80\text{ V}$ | | 89.9 | | % |
| η | Efficiency - 100% load | $I_O = I_{Omax}$, $V_O = 1.80\text{ V}$ | 86.1 | 89.1 | | % |
| P_d | Power Dissipation | $I_O = I_{Omax}$, $V_O = 1.80\text{ V}$ | | 3.5 | 4.6 | W |
| F_o | Switching frequency | $I_O = (0... 1) \times I_{Omax}$ | 260 | 300 | 340 | kHz |
| I_{sense} | Remote sense current | | | | 10 | mA |
| I_I | Static input current $V_I = 8.3\text{ V}$ | $I_O = I_{Omax}$, $V_O = 1.80\text{ V}$ | | 4.0 | | A |
| MTBF | Predicted reliability | | | 5 | | million hours |

Adjusted to 1.8 Vout - Typical Characteristics

General conditions: Input filter 4 x 4.7 μ F, Output filter 2 x 150 μ F

Efficiency

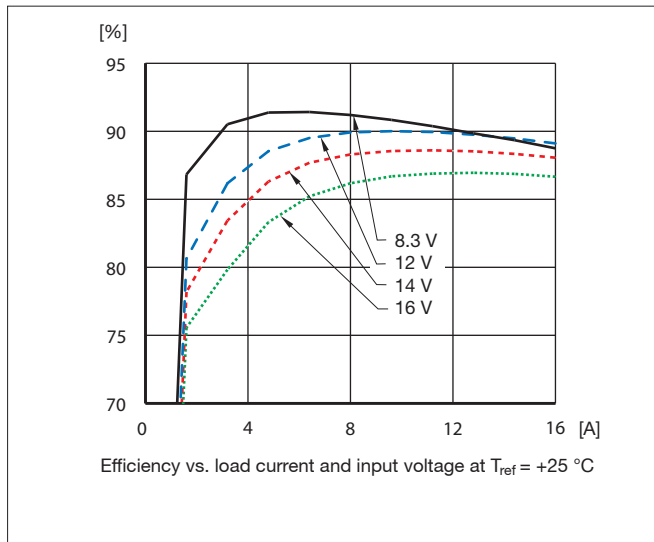

Power Dissipation

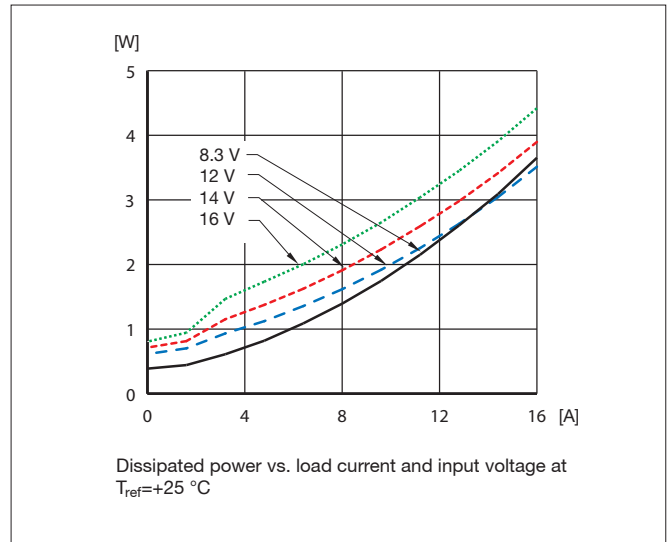

Output Current Derating at 12 V input

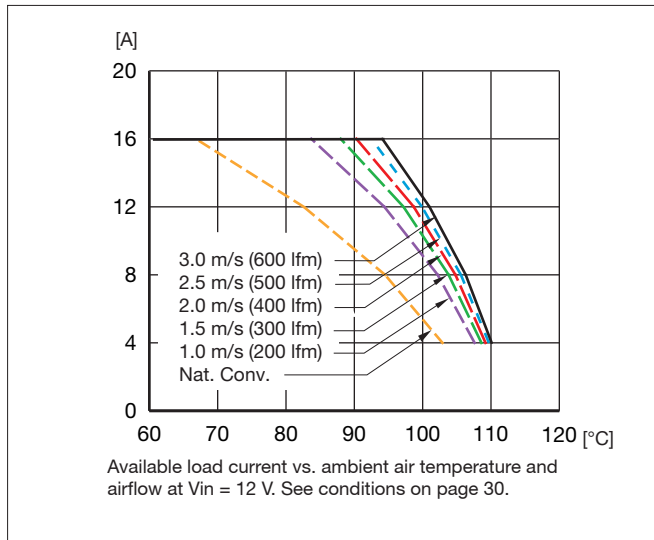

Output Characteristic

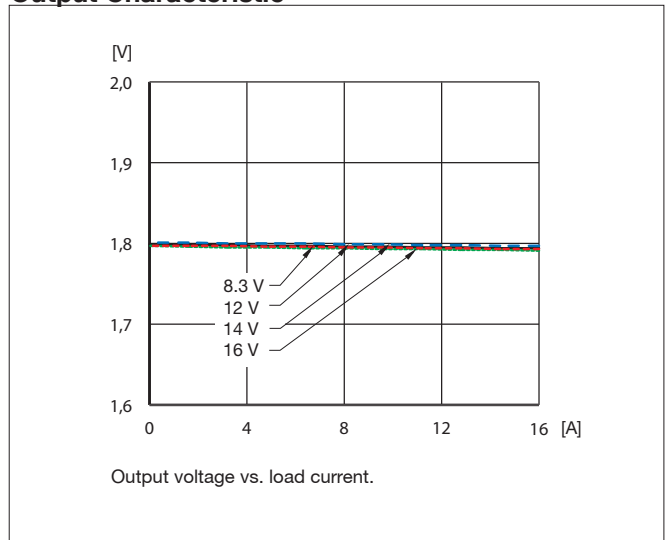

Start-Up

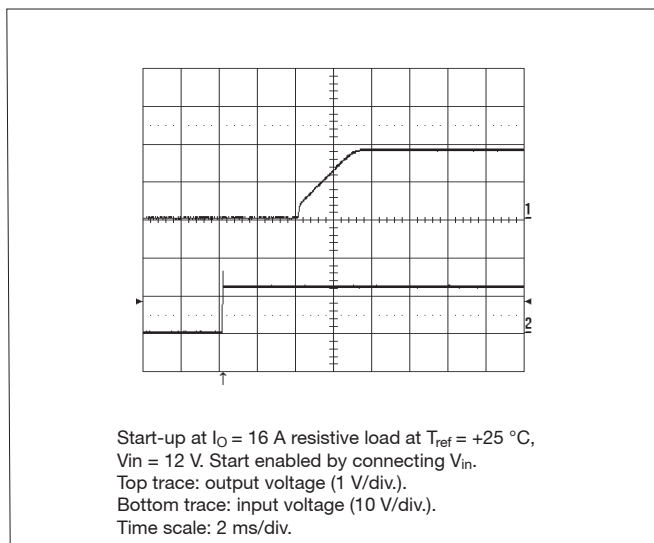

Turn Off

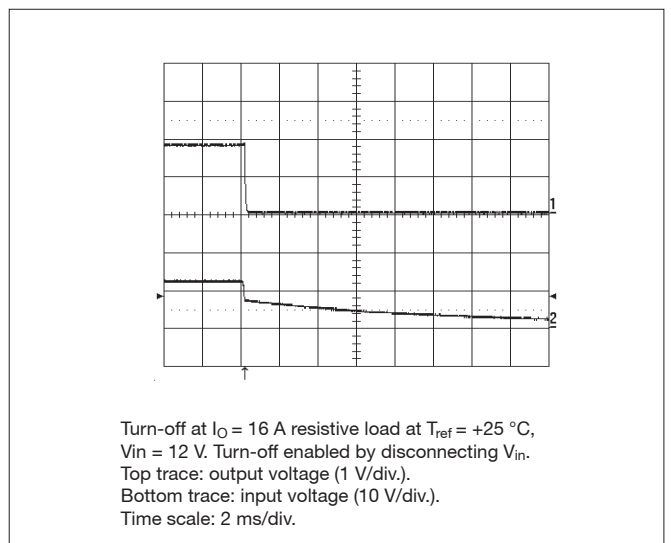

Adjusted to 1.8 Vout - Typical Characteristics

General conditions: Input filter 4 x 4.7 μ F, Output filter 2 x 150 μ F

Output Ripple

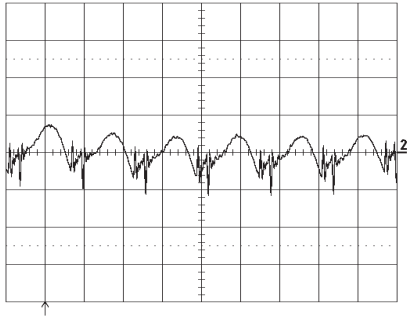

Output voltage ripple (20 mV/div.) at $T_{ref}=+25\text{ }^{\circ}\text{C}$,
 $V_{in} = 12\text{ V}$, $I_O = 16\text{ A}$ resistive load.
Band width = 5 MHz.
Time scale: 2 μ s/div.

Transient

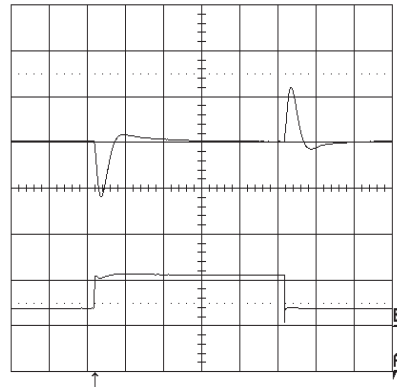

Output voltage response to load current step-change
(4-12-4 A) at $T_{ref}=+25\text{ }^{\circ}\text{C}$, $V_{in} = 12\text{ V}$. $di/dt = 5\text{ A}/\mu\text{s}$
Top trace: output voltage (ac) (100 mV/div.).
Bottom trace: load current (dc) (10 A/div.)
Time scale: 0.1 ms/div.

Adjusted to 2.5 Vout - Data

$T_{ref} = -30 \dots +90 \text{ }^\circ\text{C}$, $V_I = 8.3 \dots 16 \text{ V}$ unless otherwise specified. Input filter $4 \times 4.7 \text{ } \mu\text{F}$, Output filter $2 \times 150 \text{ } \mu\text{F}$
 Typ values specified at: $T_{ref} = +25 \text{ }^\circ\text{C}$ and V_{Inom} . $I_{Omax} = 16 \text{ A}$. Note: +Sense connected to +Out. $R_{adj} 5\text{-}009 \text{ k}\Omega$

| Characteristics | | Conditions | Output | | | Unit |
|-----------------|--|---|--------|-----------|-----|----------------------------|
| | | | min | typ | max | |
| dV_{O_i} | Output voltage adjusted setting | $T_{ref} = +25 \text{ }^\circ\text{C}$, V_{Inom} , I_{Omax} | -2 | | +2 | % V_O |
| dV_O | Output voltage tolerance band | $I_O = 0.01 \dots 1.0 \times I_{Omax}$ | -3 | | +3 | % V_O |
| dV_O | Idling voltage | $I_O = 0 \text{ A}$ | -2 | | +2 | % V_O |
| dV_O | Line regulation | $V_{Imin} \dots V_{Imax}$, I_{Omax} | | 6 | | mV |
| dV_O | Load regulation | $I_O = 0.01 \dots 1.0 \times I_{Omax}$ | | 25 | | mV |
| t_{tr} | Load transient recovery time | Load step = $0.25\text{-}0.75\text{-}0.25 \times I_{Omax}$, $dI/dt = 5 \text{ A}/\mu\text{s}$, $C_O = 2 \times 150 \text{ } \mu\text{F}$, $V_I = 12 \text{ V}$ | | 40 | | μs |
| V_{tr} | Load transient voltage | $V_I = 12 \text{ V}$ | | ± 140 | | mV |
| T_{coeff} | Temperature coefficient | $T_{ref} = -30 \dots +90 \text{ }^\circ\text{C}$, I_{Omax} | | -0.6 | | $\text{mV}/^\circ\text{C}$ |
| t_s | Start-up V_I on to $0.9 \times V_O$ | $I_O = I_{Omax}$, V_{Inom} | | 7 | | ms |
| t_r | Ramp-up, $V_I \dots 0.9 \times V_O$ | $I_O = I_{Omax}$, V_{Inom} | | 3 | | ms |
| t_f | Fall time, V_I to $0.1 \times V_O$ | $I_O = I_{Omax}$, V_{Inom} | | 1 | | ms |
| t_f | Fall time, V_I to $0.1 \times V_O$ | $I_O = 0 \text{ A}$, V_{Inom} | | 16 | | s |
| t_{RC} | RC shut-down time $0.1 \times V_O$ | $I_O = I_{Omax}$, V_{Inom} | | 1 | | ms |
| t_{RC} | RC start-up time $0.9 \times V_O$ | $I_O = I_{Omax}$, V_{Inom} | | 7 | | ms |
| t_{RC} | RC fall time, $0.1 \times V_O$ | $I_O = 0 \text{ A}$, V_{Inom} | | 16 | | s |
| I_O | Output current | | 0 | | 16 | A |
| P_{Omax} | Max output power | | 40 | | | W |
| I_{lim} | Current limiting threshold | $T_{ref} < T_{refmax}$ | 19 | | | A |
| V_{Oac} | Output ripple | 20 Hz ... 5 MHz, I_{Omax} | | 50 | | mV_{p-p} |
| η | Efficiency - 50% load | $I_O = 0.5 \times I_{Omax}$, $V_O = 2.50 \text{ V}$ | | 91.9 | | % |
| η | Efficiency - 100% load | $I_O = I_{Omax}$, $V_O = 2.50 \text{ V}$ | 88.8 | 91.3 | | % |
| P_d | Power Dissipation | $I_O = I_{Omax}$, $V_O = 2.50 \text{ V}$ | | 3.8 | 5.0 | W |
| F_o | Switching frequency | $I_O = (0 \dots 1) \times I_{Omax}$ | 260 | 300 | 340 | kHz |
| I_{sense} | Remote sense current | | | | 10 | mA |
| I_I | Static input current $V_I = 8.3 \text{ V}$ | $I_O = I_{Omax}$, $V_O = 2.50 \text{ V}$ | | 5.3 | | A |
| MTBF | Predicted reliability | | | 5 | | million hours |

Adjusted to 2.5 Vout - Typical Characteristics

General conditions: Input filter 4 x 4.7 μ F, Output filter 2 x 150 μ F

Efficiency

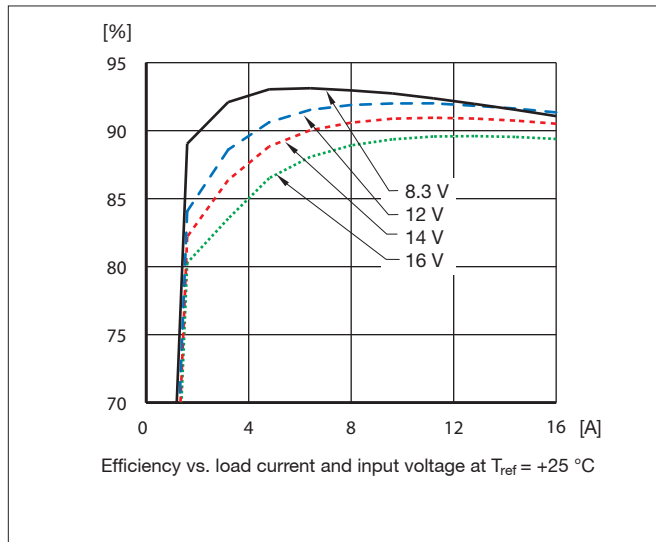

Power Dissipation

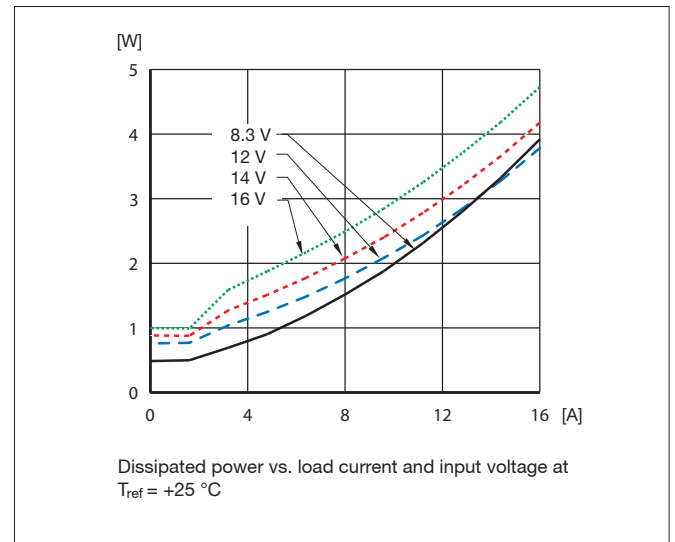

Output Current Derating at 12 V input

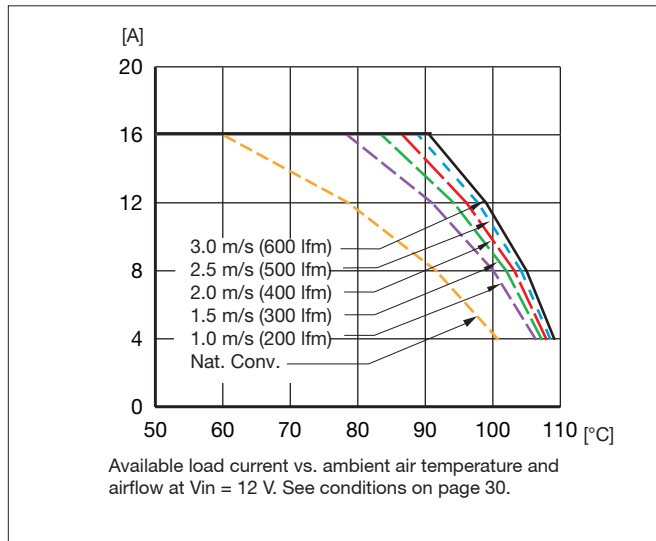

Output Characteristic

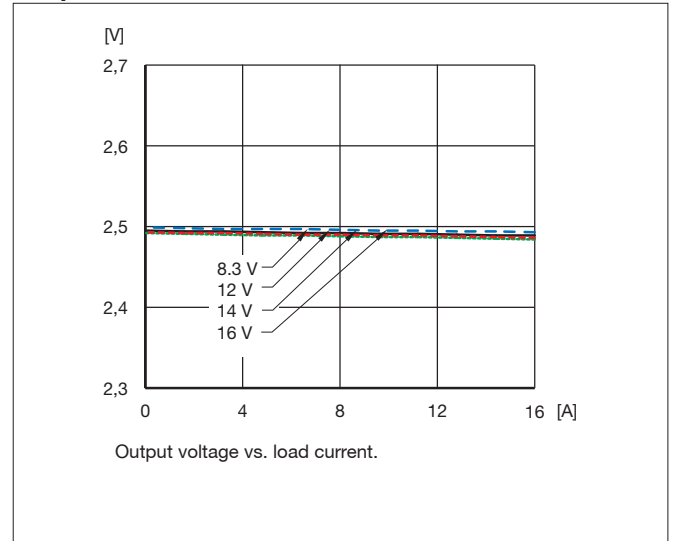

Start-Up

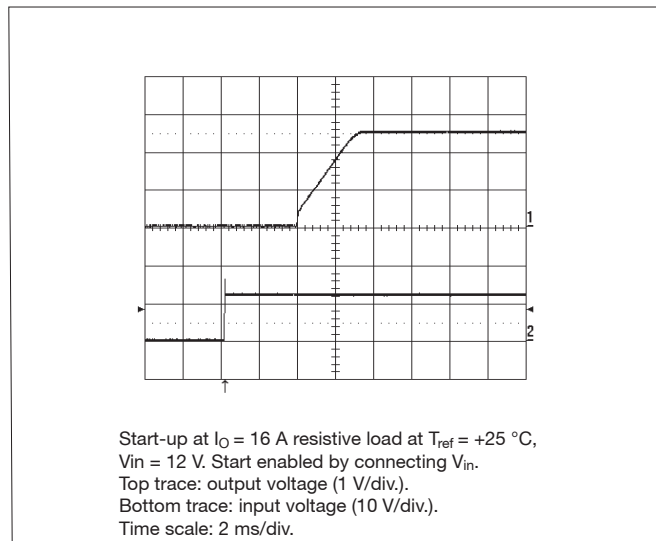

Turn Off

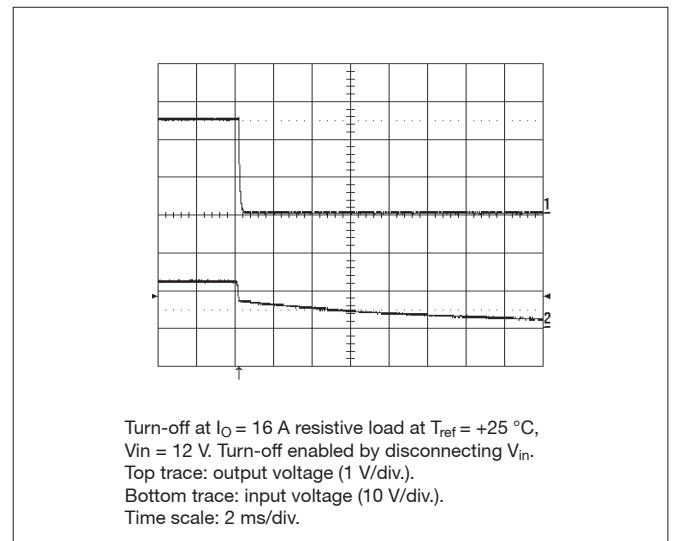

Adjusted to 2.5 Vout - Typical Characteristics

General conditions: Input filter 4 x 4.7 μF , Output filter 2 x 150 μF

Output Ripple

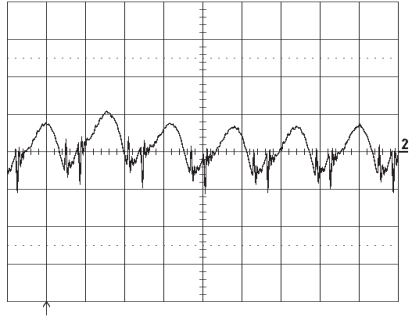

Output voltage ripple (20 mV/div.) at $T_{\text{ref}} = +25\text{ }^\circ\text{C}$,
 $V_{\text{in}} = 12\text{ V}$, $I_{\text{O}} = 16\text{ A}$ resistive load.
Band width = 5 MHz.
Time scale: 2 $\mu\text{s}/\text{div}$.

Transient

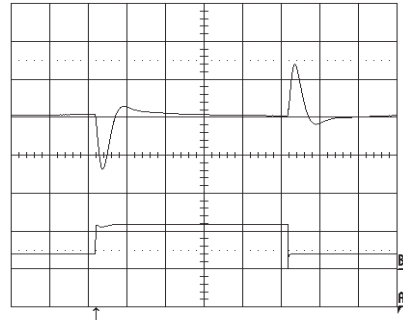

Output voltage response to load current step-change
(4-12-4 A) at $T_{\text{ref}} = +25\text{ }^\circ\text{C}$, $V_{\text{in}} = 12\text{ V}$. $dI/dt = 5\text{ A}/\mu\text{s}$
Top trace: output voltage (ac) (100 mV/div.).
Bottom trace: load current (dc) (10 A/div.)
Time scale: 0.1 ms/div.

Adjusted to 3.3 Vout - Data

$T_{ref} = -30 \dots +90 \text{ }^\circ\text{C}$, $V_I = 8.3 \dots 16 \text{ V}$ unless otherwise specified. Input filter $4 \times 4.7 \text{ } \mu\text{F}$, Output filter $2 \times 150 \text{ } \mu\text{F}$
 Typ values specified at: $T_{ref} = +25 \text{ }^\circ\text{C}$ and V_{Inom} . $I_{Omax} = 16 \text{ A}$. Note: +Sense connected to +Out. $R_{adj} 3.122 \text{ k}\Omega$

| Characteristics | | Conditions | Output | | | Unit |
|-----------------|--|---|--------|-----------|-----|----------------------------|
| | | | min | typ | max | |
| dV_{O_i} | Output voltage adjusted setting | $T_{ref} = +25 \text{ }^\circ\text{C}$, V_{Inom} , I_{Omax} | -2 | | +2 | % V_O |
| dV_O | Output voltage tolerance band | $I_O = 0.01 \dots 1.0 \times I_{Omax}$ | -3 | | +3 | % V_O |
| dV_O | Idling voltage | $I_O = 0 \text{ A}$ | -2 | | +2 | % V_O |
| dV_O | Line regulation | $V_{Imin} \dots V_{Imax}$, I_{Omax} | | 6 | | mV |
| dV_O | Load regulation | $I_O = 0.01 \dots 1.0 \times I_{Omax}$ | | 25 | | mV |
| t_{tr} | Load transient recovery time | Load step = $0.25-0.75-0.25 \times I_{Omax}$, $dI/dt = 5 \text{ A}/\mu\text{s}$, $C_O = 2 \times 150 \text{ } \mu\text{F}$, $V_I = 12 \text{ V}$ | | 40 | | μs |
| V_{tr} | Load transient voltage | $V_I = 12 \text{ V}$ | | ± 140 | | mV |
| T_{coeff} | Temperature coefficient | $T_{ref} = -30 \dots +90 \text{ }^\circ\text{C}$, I_{Omax} | | -0.6 | | $\text{mV}/^\circ\text{C}$ |
| t_s | Start-up V_I on to $0.9 \times V_O$ | $I_O = I_{Omax}$, V_{Inom} | | 7 | | ms |
| t_r | Ramp-up, $V_I \dots 0.9 \times V_O$ | $I_O = I_{Omax}$, V_{Inom} | | 3 | | ms |
| t_f | Fall time, V_I to $0.1 \times V_O$ | $I_O = I_{Omax}$, V_{Inom} | | 1 | | ms |
| t_f | Fall time, V_I to $0.1 \times V_O$ | $I_O = 0 \text{ A}$, V_{Inom} | | 17 | | s |
| t_{RC} | RC shut-down time $0.1 \times V_O$ | $I_O = I_{Omax}$, V_{Inom} | | 1 | | ms |
| t_{RC} | RC start-up time $0.9 \times V_O$ | $I_O = I_{Omax}$, V_{Inom} | | 7 | | ms |
| t_{RC} | RC fall time, $0.1 \times V_O$ | $I_O = 0 \text{ A}$, V_{Inom} | | 17 | | s |
| I_O | Output current | | 0 | | 16 | A |
| P_{Omax} | Max output power | | 52.8 | | | W |
| I_{lim} | Current limiting threshold | $T_{ref} < T_{refmax}$ | 19 | | | A |
| V_{Oac} | Output ripple | 20 Hz ... 5 MHz, I_{Omax} | | 50 | | mV_{p-p} |
| η | Efficiency - 50% load | $I_O = 0.5 \times I_{Omax}$, $V_O = 3.30 \text{ V}$ | | 93.2 | | % |
| η | Efficiency - 100% load | $I_O = I_{Omax}$, $V_O = 3.30 \text{ V}$ | 90.6 | 92.9 | | % |
| P_d | Power Dissipation | $I_O = I_{Omax}$, $V_O = 3.30 \text{ V}$ | | 4.0 | 5.5 | W |
| F_o | Switching frequency | $I_O = (0 \dots 1) \times I_{Omax}$ | 260 | 300 | 340 | kHz |
| I_{sense} | Remote sense current | | | | 10 | mA |
| I_I | Static input current $V_I = 8.3 \text{ V}$ | $I_O = I_{Omax}$, $V_O = 3.30 \text{ V}$ | | 6.9 | | A |
| MTBF | Predicted reliability | | | 5 | | million hours |

Adjusted to 3.3 Vout - Typical Characteristics

General conditions: Input filter 4 x 4.7 μ F, Output filter 2 x 150 μ F

Efficiency

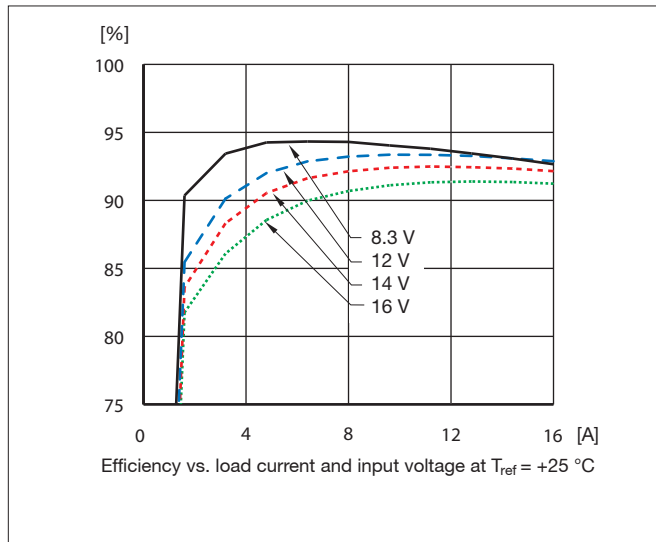

Power Dissipation

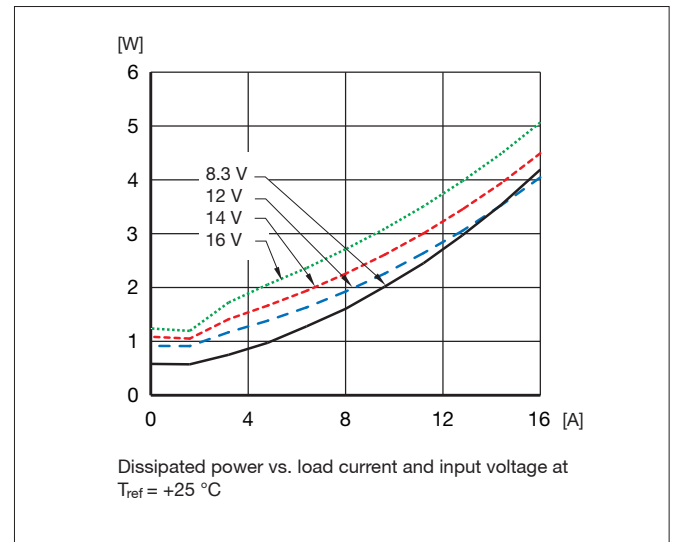

Output Current Derating at 12 V input

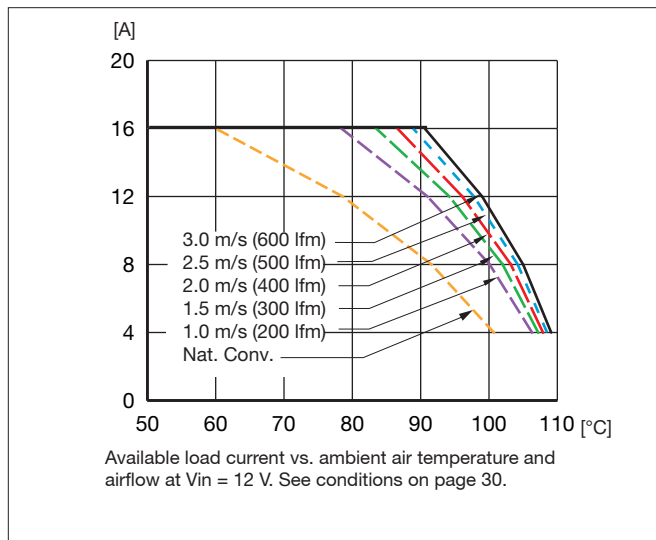

Output Characteristic

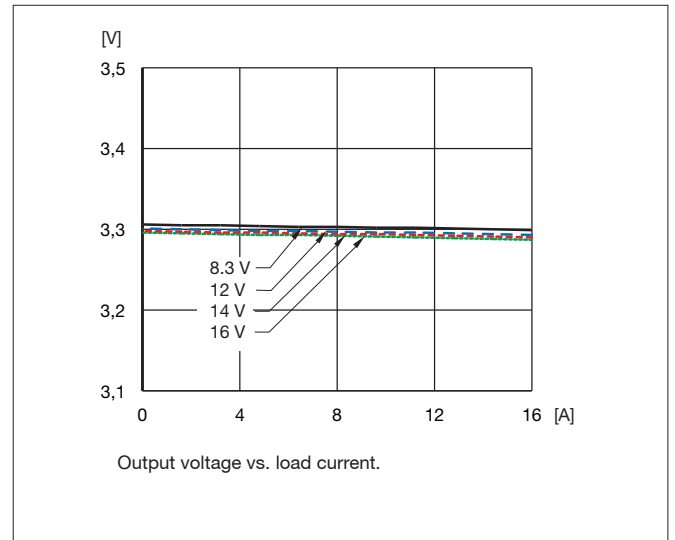

Start-Up

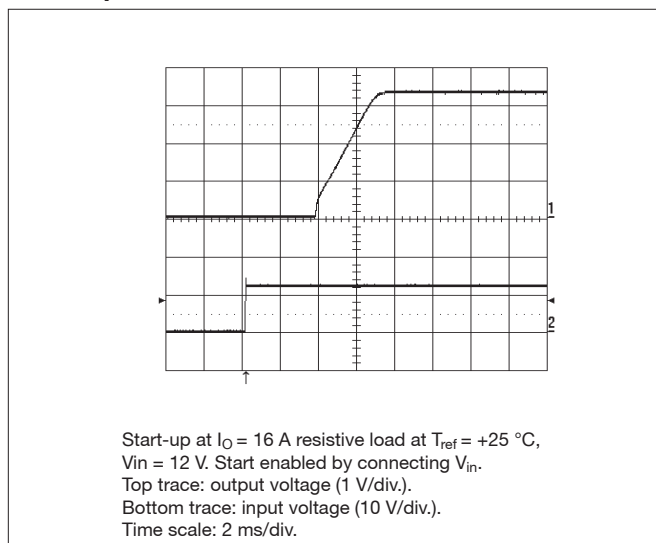

Turn Off

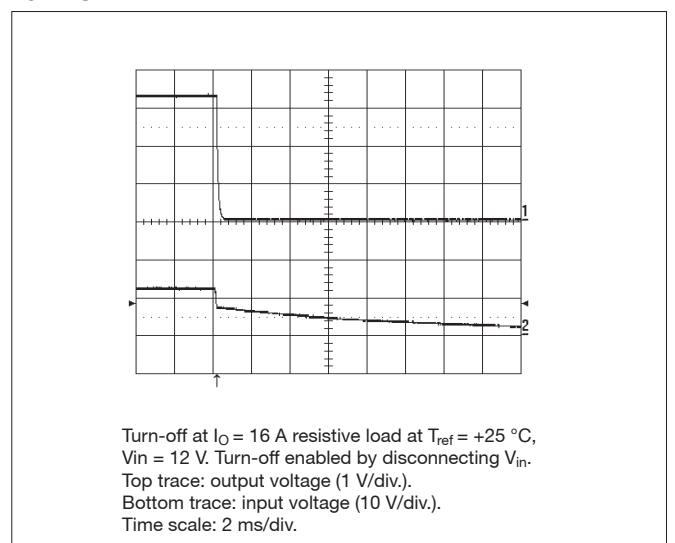

Adjusted to 3.3 Vout - Typical Characteristics

General conditions: Input filter 4 x 4.7 μF , Output filter 2 x 150 μF

Output Ripple

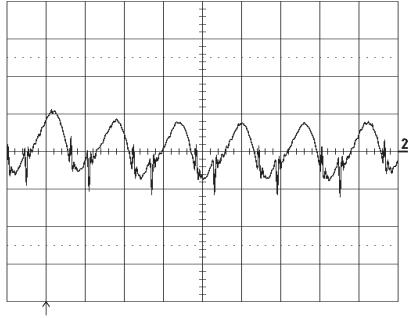

Output voltage ripple (20 mV/div.) at $T_{\text{ref}} = +25\text{ }^{\circ}\text{C}$,
 $V_{\text{in}} = 12\text{ V}$, $I_{\text{O}} = 16\text{ A}$ resistive load.
Band width = 5 MHz.
Time scale: 2 $\mu\text{s}/\text{div}$.

Transient

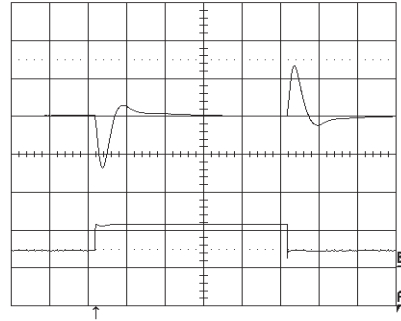

Output voltage response to load current step-change
(4-12-4 A) at $T_{\text{ref}} = +25\text{ }^{\circ}\text{C}$, $V_{\text{in}} = 12\text{ V}$, $dI/dt = 5\text{ A}/\mu\text{s}$
Top trace: output voltage (ac) (100 mV/div.).
Bottom trace: load current (dc) (10 A/div.)
Time scale: 0.1 ms/div.

Adjusted to 5.0 Vout - Data

$T_{ref} = -30 \dots +90 \text{ }^\circ\text{C}$, $V_I = 8.3 \dots 16 \text{ V}$ unless otherwise specified. Input filter $4 \times 4.7 \text{ } \mu\text{F}$, Output filter $2 \times 150 \text{ } \mu\text{F}$
 Typ values specified at: $T_{ref} = +25 \text{ }^\circ\text{C}$ and V_{Inom} . $I_{Omax} = 16 \text{ A}$. Note: +Sense connected to +Out. $R_{adj} 1.472 \text{ k}\Omega$

| Characteristics | | Conditions | Output | | | Unit |
|--------------------|--|--|--------|--------------|-----|----------------------|
| | | | min | typ | max | |
| dV _{Oi} | Output voltage adjusted setting | $T_{ref} = +25 \text{ }^\circ\text{C}$, V_{Inom} , I_{Omax} | -2 | | +2 | % V _O |
| dV _O | Output voltage tolerance band | $I_O = 0.01 \dots 1.0 \times I_{Omax}$ | -3 | | +3 | % V _O |
| dV _O | Idling voltage | $I_O = 0 \text{ A}$ | -2 | | +2 | % V _O |
| dV _O | Line regulation | $V_{Imin} \dots V_{Imax}$, I_{Omax} | | 12 | | mV |
| dV _O | Load regulation | $I_O = 0.01 \dots 1.0 \times I_{Omax}$ | | 25 | | mV |
| t _{tr} | Load transient recovery time | Load step = 0.25-0.75-0.25 x I_{Omax} , dI/dt = 5 A/ μs , C _O = 2 x 150 μF , $V_I = 12\text{V}$ | | 40 | | μs |
| V _{tr} | Load transient voltage | | | -150 +190 | | mV |
| T _{coeff} | Temperature coefficient | $T_{ref} = -30 \dots +90 \text{ }^\circ\text{C}$, I_{Omax} | | -0.6 | | mV/ $^\circ\text{C}$ |
| t _s | Start-up V _I on to 0.9 x V _O | $I_O = I_{Omax}$, V_{Inom} | | 7 | | ms |
| t _r | Ramp-up, V _I ... 0.9 x V _O | $I_O = I_{Omax}$, V_{Inom} | | 3 | | ms |
| t _f | Fall time, V _I to 0.1 x V _O | $I_O = I_{Omax}$, V_{Inom} | | 1 | | ms |
| t _f | Fall time, V _I to 0.1 x V _O | $I_O = 0 \text{ A}$, V_{Inom} | | 16 | | s |
| t _{RC} | RC shut-down time 0.1 x V _O | $I_O = I_{Omax}$, V_{Inom} | | 1 | | ms |
| t _{RC} | RC start-up time 0.9 x V _O | $I_O = I_{Omax}$, V_{Inom} | | 7 | | ms |
| t _{RC} | RC fall time, 0.1 x V _O | $I_O = 0 \text{ A}$, V_{Inom} | | 15 | | s |
| I _O | Output current | | 0 | | 16 | A |
| P _{Omax} | Max output power | | 80 | | | W |
| I _{lim} | Current limiting threshold | $T_{ref} < T_{refmax}$ | 19 | | | A |
| V _{Oac} | Output ripple | 20 Hz ... 5 MHz, I_{Omax} | | 50 | | mV _{p-p} |
| η | Efficiency - 50% load | $I_O = 0.5 \times I_{Omax}$, $V_O = 3.30 \text{ V}$ | | 94.9 | | % |
| η | Efficiency - 100% load | $I_O = I_{Omax}$, $V_O = 3.30 \text{ V}$ | 91.3 | 94.7 | | % |
| P _d | Power Dissipation | $I_O = I_{Omax}$, $V_O = 3.30 \text{ V}$ | | 4.5 | 7.6 | W |
| F _o | Switching frequency | $I_O = (0 \dots 1) \times I_{Omax}$ | 260 | 300 | 340 | kHz |
| I _{sense} | Remote sense current | | | | 10 | mA |
| I _I | Static input current V _I = 8.3 V | $I_O = I_{Omax}$, $V_O = 3.30 \text{ V}$ | | 10.2 | | A |
| MTBF | Predicted reliability | | | 5 | | million hours |

Adjusted to 5.0 V out - Typical Characteristics

General conditions: Input filter 4 x 4.7 μ F, Output filter 2 x 150 μ F

Efficiency

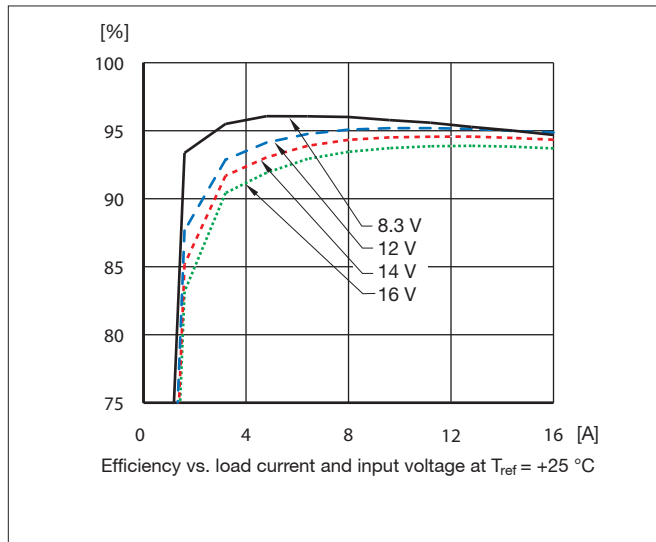

Power Dissipation

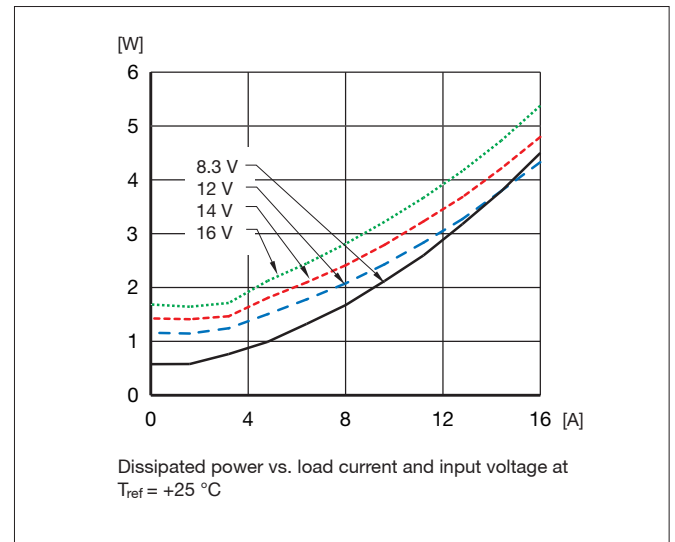

Output Current Derating at 12 V input

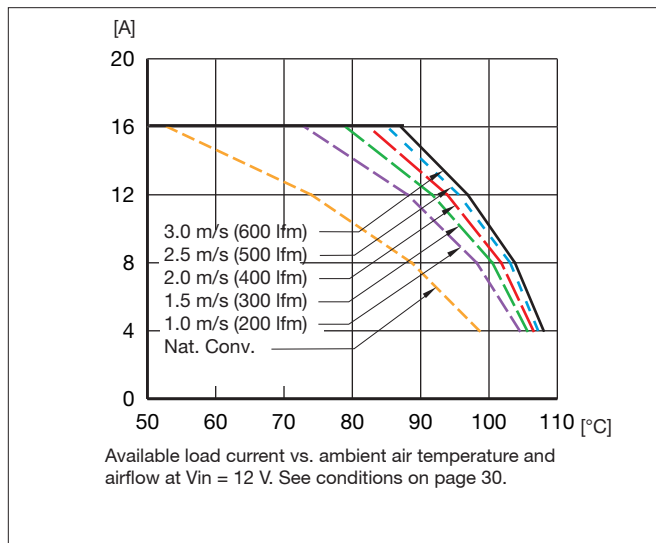

Output Characteristic

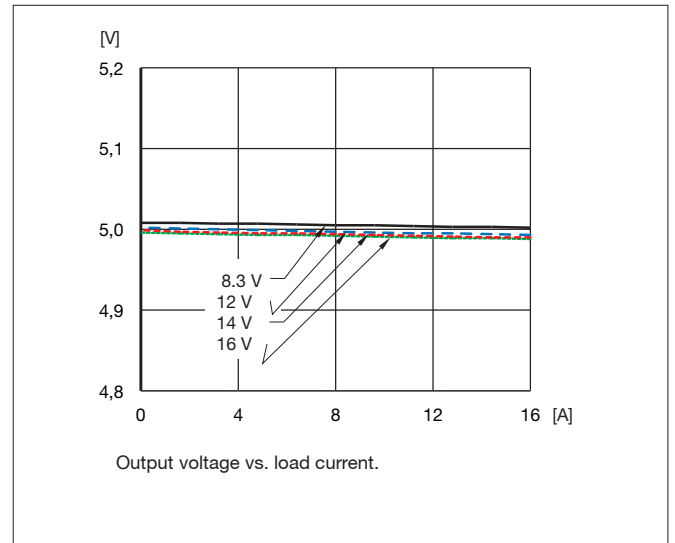

Start-Up

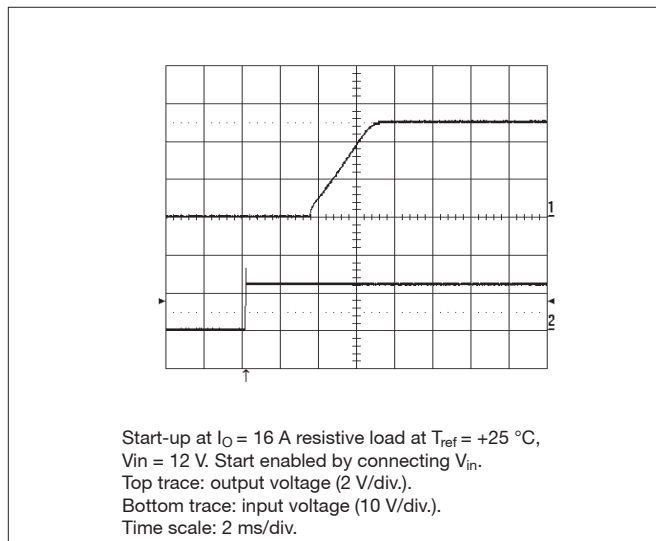

Turn Off

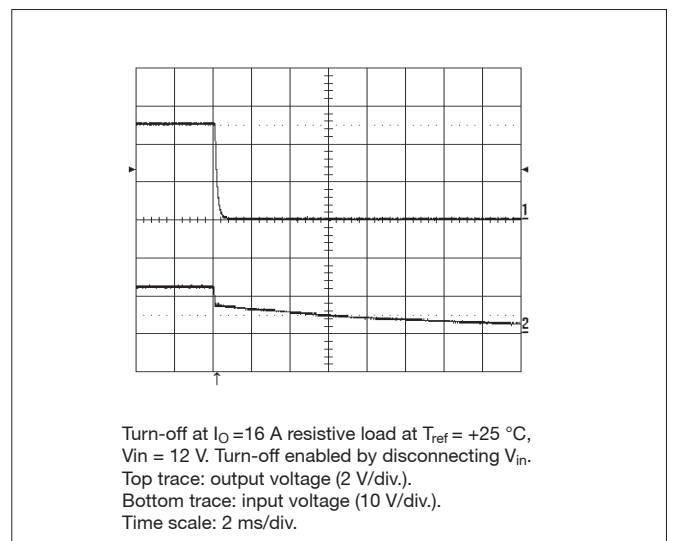

Adjusted to 5.0 V out - Typical Characteristics

General conditions: Input filter 4 x 4.7 μ F, Output filter 2 x 150 μ F

Output Ripple

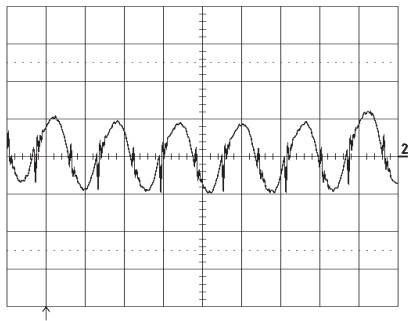

Output voltage ripple (20 mV/div.) at $T_{ref} = +25\text{ }^{\circ}\text{C}$,
 $V_{in} = 12\text{ V}$, $I_O = 16\text{ A}$ resistive load.
Band width = 5 MHz.
Time scale: 2 μ s/div.

Transient

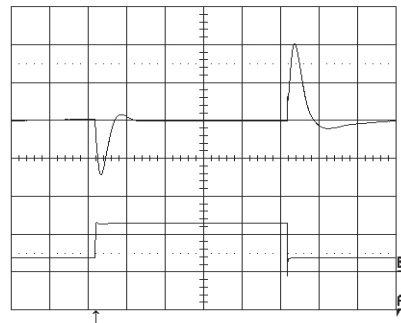

Output voltage response to load current step-change
(4-12-4 A) at $T_{ref} = +25\text{ }^{\circ}\text{C}$, $V_{in} = 12\text{ V}$. $dI/dt = 5\text{ A}/\mu\text{s}$
Top trace: output voltage (ac) (100 mV/div.).
Bottom trace: load current (dc) (10 A/div.)
Time scale: 0.1 ms/div.

EMC Specification

The conducted EMI measurement was performed using a regulator placed directly on the test bench. The fundamental switching frequency for PMC 8000 is 300 kHz. The measurement below has been performed with $V_{in} = 12\text{ V}$, $V_{out} = 5\text{ V}$ and max load. Input filter $4 \times 4.7\text{ }\mu\text{F}$ and output filter $2 \times 150\text{ }\mu\text{F}$ was used during the measurement.

Conducted EMI Input terminal value (typ)

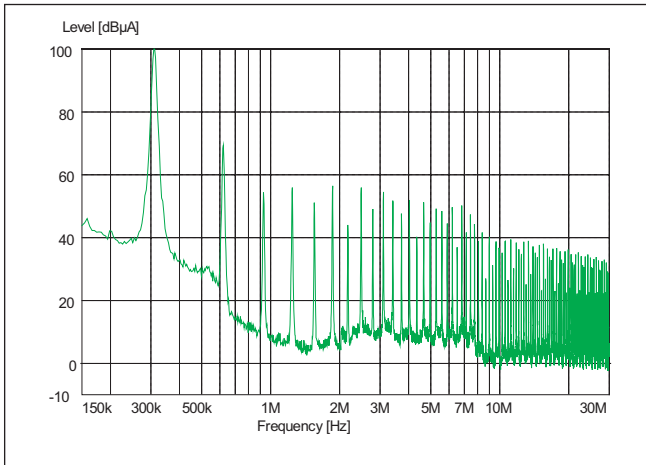

PMC 8818.

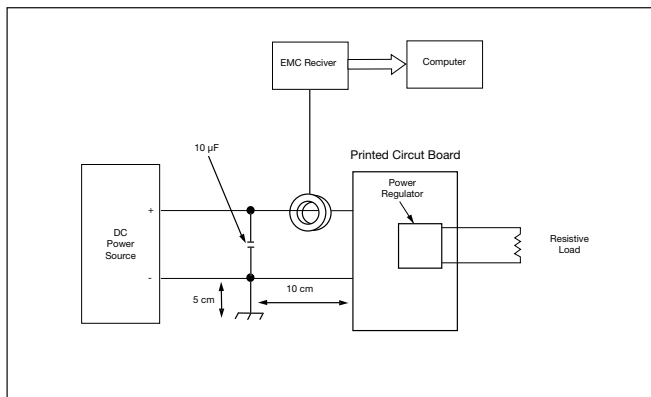

Layout Recommendation

The radiated EMI performance of the DC/DC regulator will be optimised by including a ground plane in the PCB area under the DC/DC regulator. This approach will return switching noise to ground as directly as possible, with improvements to both emissions and susceptibility.

Output ripple and noise

The circuit below has been used for the ripple and noise measurements on the PMC 8000 Series DC/DC regulators.

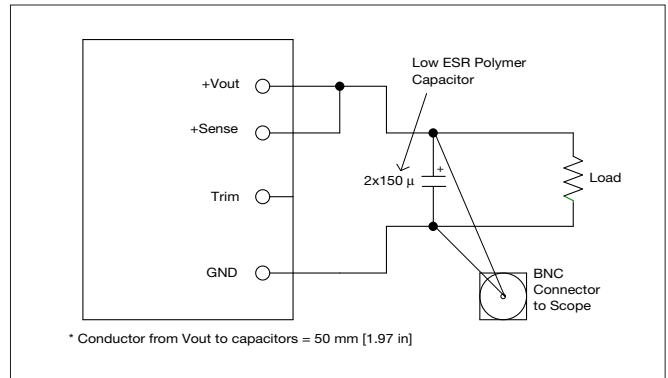

Output ripple and noise test setup

Operating Information

Output Voltage Adjust (V_{adj})

All PMC 8000 Series DC/DC regulators have an Output Voltage adjust pin (V_{adj}). This pin can be used to adjust the output voltage above output voltage initial setting (0.75 V). When increasing the output voltage the maximum power rating of the converter remains the same, and the output current capability will therefore decrease correspondingly. To increase the output voltage a resistor or a voltage signal should be connected/applied between V_{adj} pin and GND. The resistor/voltage signal value for some standard output trims are given below, for other voltage set points use the formulas to calculate the correct resistor or voltage signal. For output voltages of 5.25 V and higher the input voltage is restricted to maximum 14 V_{in} .

Formula 1: $R_{adj} = (10\ 500 / (V_{out} - 0.7525)) - 1000$ (ohm)

Formula 2: $V_{trim} = (0.7 - 0.0667 \times (V_{out} - 0.7525))$ (V)

| Vout (V) | Radj (kohm) | Vtrim (V) |
|----------|-------------|-----------|
| 0.75 | Open | Open |
| 1.0 | 41.42 | 0.684 |
| 1.2 | 22.46 | 0.670 |
| 1.5 | 13.05 | 0.650 |
| 1.8 | 9.024 | 0.630 |
| 2.5 | 5.009 | 0.583 |
| 3.3 | 3.122 | 0.530 |
| 5.00 | 1.472 | 0.417 |
| 5.50 | 1.212 | 0.383 |

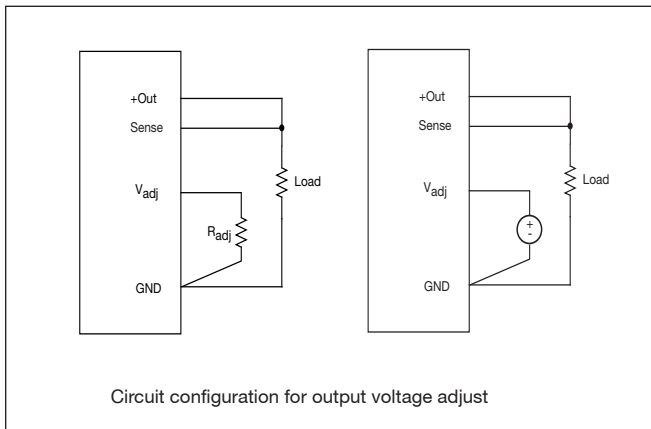

Input Voltage

The input voltage range 8.3...16 Vdc makes the PMC 8000 easy to use in intermediate bus applications when powered by a non-regulated bus converter or a regulated bus converter. For output voltage trims over 5.25 V_{out} the input voltage must be reduced to a maximum of 14 V in order to maintain specified data.

Turn off input voltage

The PMC 8000 Series DC/DC regulators monitor the input voltage and will turn on and turn off at predetermined levels. The minimum hysteresis between turn on and turn off input voltage is 0.2 V where the turn on input voltage is the highest.

Remote Control (RC)

Standard Version with "positive logic".

The RC pin may be used to turn on or turn off the regulator using a suitable open collector function.

Turn off is achieved by connecting the RC pin to ground.

The regulator will run in normal operation when the RC pin is left open.

| RC | Regulator condition | min | typ | max | Unit |
|-----------------------------|---------------------|------|-----|-----|------|
| Low level referenced to GND | OFF | -0.3 | | 0.3 | V |
| Open | ON | 1.7 | | 16 | V |

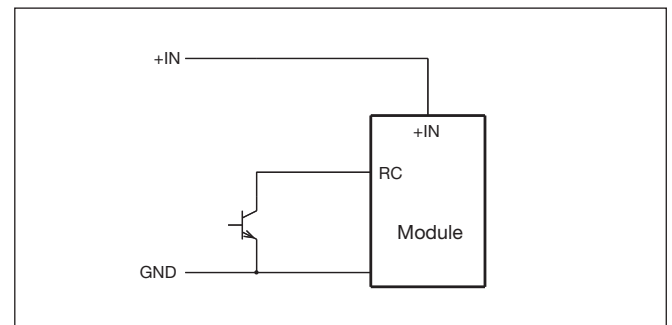

Option "negative logic"

The RC pin may be used to turn on or turn off the regulator using a suitable open collector function.

Turn off is achieved by connecting the RC pin to the input voltage.

The regulator will run in normal operation when the RC pin is left open.

| RC | Regulator condition | min | typ | max | Unit |
|------------------------------|---------------------|-----|-----|-----|------|
| High level referenced to GND | OFF | 1.7 | | 16 | V |
| Open | ON | | | | |

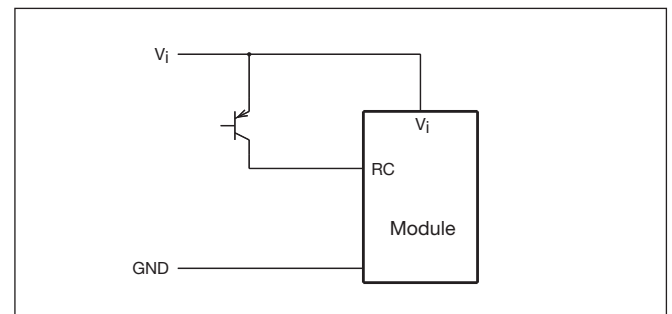

Operating Information

Remote Sense

All PMC 8000 Series DC/DC regulators have a positive remote sense pin that can be used to compensate for moderate amounts of resistance in the distribution system and allow for voltage regulation at the load or other selected point. The remote sense line will carry very little current and does not need a large cross sectional area. However, the sense line on the PCB should be located close to a ground trace or ground plane. The remote sense circuitry will compensate for up to 10% voltage drop between the sense voltage and the voltage at the output pins from $V_{O\text{nom}}$. If the remote sense is not needed the sense pin should be left open or connected to the positive output.

Current Limit Protection

The PMC 8000 Series DC/DC regulators include current limiting circuitry that allows them to withstand continuous overloads or short circuit conditions on the output. The output voltage will decrease towards zero for output currents in excess of max output current (I_{omax}). When the current limit is reached the regulator will go into hiccup mode.

The current limit is temperature dependent, i.e. the limit decrease at higher operating temperature, the regulator is guaranteed to start at $I_{\text{omax}} \times 1.25$ @ $T_{\text{ref}} 115^{\circ}\text{C}$.

The regulator will resume normal operation after removal of the overload. The load distribution system should be designed to carry the maximum output short circuit current specified.

Over Temperature Protection (OTP)

The PMC 8000 Series DC/DC regulators are protected from thermal overload by an internal over temperature shutdown circuit. When the PCB temperature near the IC circuit reaches 130°C the converter will shut down immediately. The regulator will make continuous attempts to start up (non-latching mode) and resume normal operation automatically when the temperature has dropped below the temperature threshold.

Input And Output Impedance

The impedance of both the power source and the load will interact with the impedance of the DC/DC regulator. It is most important to have a low characteristic impedance, both at the input and output, as the regulators have a low energy storage capability. Use capacitors across the input if the source inductance is greater than $4.7\ \mu\text{H}$. Suitable input capacitors are $22\ \mu\text{F}$ - $220\ \mu\text{F}$ low ESR ceramics.

Minimum Required External Capacitors

Required Input Filter

External input capacitors are required to increase the lifetime of the internal capacitors. Low ESR ceramics should be used, the minimum input capacitance is stated below.

PMC 8818T S $2 \times 4.7\ \mu\text{F}$.

Optional Input Filter

To minimize input ripple and to ensure even better stability more capacitors can be added, see table below.

Consider the max output power in a given application and choose sufficient capacitors to obtain desired ripple level. Make sure that the extra capacitors are placed near the input pins.

The table below is just an example since the board layout also has effect on the result.

| Output power | Desired input ripple (mV _{p-p}) | | |
|--------------|---|-----------------------------|-----------------------------|
| | 150 | 250 | 500 |
| 0-20 W | $2 \times 4.7\ \mu\text{F}$ | ----- | ----- |
| 20-40 W | $5 \times 4.7\ \mu\text{F}$ | $2 \times 4.7\ \mu\text{F}$ | ----- |
| 40-60 W | $8 \times 4.7\ \mu\text{F}$ | $4 \times 4.7\ \mu\text{F}$ | $2 \times 4.7\ \mu\text{F}$ |
| 60-80 W | $11 \times 4.7\ \mu\text{F}$ | $7 \times 4.7\ \mu\text{F}$ | $4 \times 4.7\ \mu\text{F}$ |

Note: All output characteristics in the datasheet are measured with $4 \times 4.7\ \mu\text{F}$ at the input pins.

Required output filter

External output capacitance is also required to reduce the output ripple and to obtain specified load step response. It is recommended to use low ESR polymer capacitors or low ESR ceramic capacitors.

Minimum requirement:

PMC 8818T S $2 \times 150\ \mu\text{F}$. (low ESR polymer type).

This is the output filter used in the verification and a requirement to meet the specification.

Maximum Capacitive Load

When powering loads with significant dynamic current requirements, the voltage regulation at the load can be improved by addition of decoupling capacitance at the load. The most effective technique is to locate low ESR ceramic capacitors as close to the load as possible, using several capacitors to lower the total ESR. These ceramic capacitors will handle short duration high-frequency components of dynamic load changes. In addition, higher values of capacitors (electrolytic capacitors) should be used to handle the mid-frequency components. It is equally important to use good design practice when configuring the DC distribution system.

Low resistance and low inductance PCB layouts and cabling should be used. Remember that when using remote sensing, all resistance (including the ESR), inductance and capacitance of the distribution system is within the feedback loop of the regulator. This can affect on the regulators compensation and the resulting stability and dynamic response performance.

Very low ESR and high capacitance must be used with care. A "rule of thumb" is that the total capacitance must never exceed typically $500\text{-}700\ \mu\text{F}$ if only low ESR ($< 2\ \text{mW}$) ceramic capacitors is used. If more capacitance is needed, a combination of low ESR type and electrolytic capacitors should be used, otherwise the stability will be affected.

The PMC 8000 series regulator can accept up to $8\ \text{mF}$ of capacitive load on the output at full load. This gives $< 500\ \mu\text{F/A}$ of I_{O} . When using that large capacitance it is important to consider the selection of output capacitors; the resulting behavior is a combination of the amount of capacitance and ESR.

A combination of low ESR and output capacitance exceeding 8 mF for PMC 8818 can cause the regulator into over current protection mode (hick-up) due to high start up current. The output filter must therefore be designed without exceeding the above stated capacitance levels if the ESR is lower then 30-40 mW.

Parallel Operation

The PMC 8000 Series DC/DC regulators can be connected in parallel with a common input. Paralleling is accomplished by connecting the output voltage pins directly and using a load sharing device on the input. Layout considerations should be made to avoid load imbalance. For more details on paralleling, please consult your local applications support.

Thermal Considerations

General

The PMC 8000 Series DC/DC regulators are designed to operate in a variety of thermal environments, however sufficient cooling should be provided to help ensure reliable operation. Heat is removed by conduction, convection and radiation to the surrounding environment. Increased airflow enhances the heat transfer via convection.

Proper cooling can be verified by measuring the temperature at the reference point (T_{ref}).

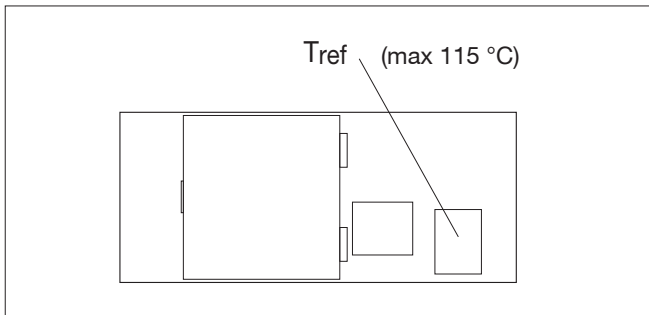

The PMC 8000 thermal testing is performed with the product mounted on an FR4 board 254 × 254 mm with 8 layers of 35 µm copper.

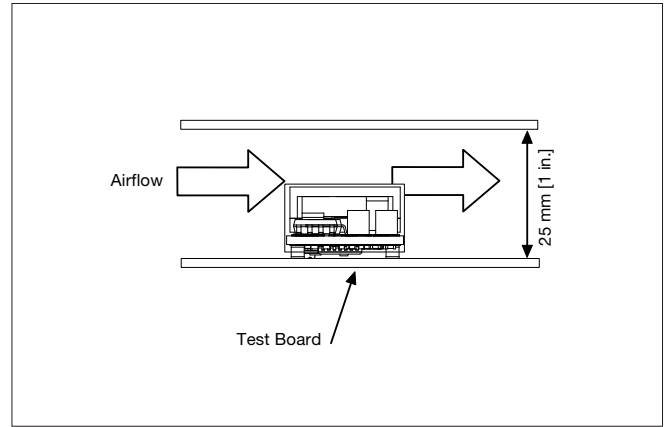

Calculation of ambient temperature

By using the thermal resistance the maximum allowed ambient temperature can be calculated.

1. The powerloss is calculated by using the formula $((1/\eta) - 1) \times \text{output power} = \text{power losses}$.
 η = efficiency of converter. E.g 88% = 0.88
2. Find the value of the thermal resistance for each product in the diagram by using the airflow speed at the output section of the converter. Take the thermal resistance x powerloss to get the temperature increase.
3. Max allowed calculated ambient temperature is: Max T_{ref} of DC/DC regulator – temperature increase.

E.g 5 V output at 1 m/s, full load, 12 V in:

A. $((\frac{1}{0.94}) - 1) \times 80 \text{ W} = 5.11 \text{ W}$

B. $5.11 \text{ W} \times 8 \text{ °C/W} = 40.9 \text{ °C}$

C. $115 \text{ °C} - 40.9 \text{ °C} = \text{max ambient temperature is } 74.1 \text{ °C}$

The real temperature will be dependent on several factors, like PCB size and type, direction of airflow, air turbulence etc. It is recommended to verify the temperature by testing.

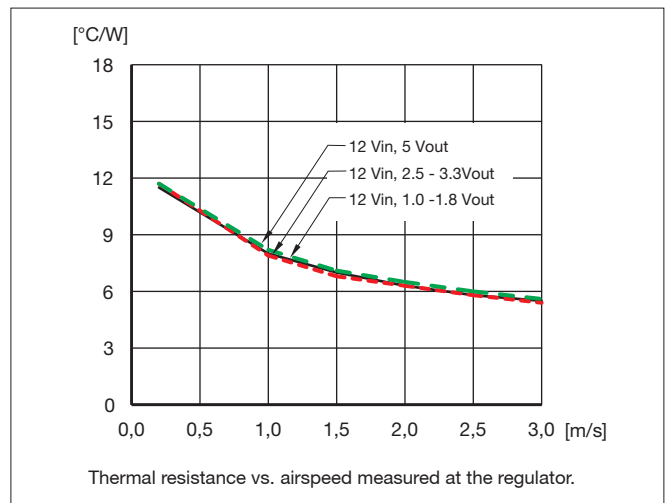

Soldering Information

The PMC series DC/DC regulators are intended for reflow soldering processes. Extra precautions must be taken when reflow soldering the module. Neglecting the soldering information given below may result in permanent damage or significant degradation of the power module performance. No responsibility is assumed if these recommendations are not strictly followed.

The module can be reflow soldered using vapour phase reflow (VPR) or forced convection reflow.

To ensure proper soldering of the regulators the temperature should be monitored on interconnection pin GND. The interconnection GND is considered as representative due to the heavy copper path characterisation. A thermocouple can be attached to the pin GND by means of a suitable adhesive or heat conductive paste, see the mechanical data on page 4.

The reflow profile should be optimised to avoid solder paste drying and overheating of the module. Most important is to ensure that the interconnection pins on the coldest area reach sufficient soldering temperature for sufficiently long time. A sufficiently extended soak time is recommended to ensure an even temperature throughout the PCB, for both small and large components. To reduce the risk of overheating the power module, it is also recommended to minimise the time in reflow as much as possible.

High temperature solders - Reflow profile

| Ramp up, ramp-down rate | | | |
|----------------------------|---------------------|----------------------|-----------|
| Pre-heat | Soak zone | Reflow zone | Cooling |
| max 3°C/s | max 0.5°C/s | max 3°C/s | max 4°C/s |
| Temperature interval, time | | | |
| | Soak zone | Reflow zone | |
| | 150-200°C, 60-180 s | Above 220°C, 30-80 s | |
| Peak temperature, time | | | |
| | | Reflow zone | |
| | | 235-245°C, 10-30 s | |

For lead free solder processes (solder melting point 217°C), the PMC series is qualified for MSL 1 according to JEDEC standard "J-STD-020c". During reflow, the module temperature must not exceed +245 °C at any time.

Low temperature solder - reflow profile

| Ramp up, ramp-down rate | | | |
|----------------------------|---------------------|----------------------|-----------|
| Pre-heat | Soak zone | Reflow zone | Cooling |
| max 3°C/s | max 0.5°C/s | max 3°C/s | max 4°C/s |
| Temperature interval, time | | | |
| | Soak zone | Reflow zone | |
| | 130-170°C, 60-120 s | Above 183°C, 30-80 s | |
| Peak temperature, time | | | |
| | | Reflow zone | |
| | | 210-225°C, 10-30 s | |

For conventional Sn-Pb solder processes (solder melting point 179°C -183°C), The PMC series is qualified for MSL 1 according to JEDEC standard "J-STD-020c". During reflow, the module temperature must not exceed +225 °C at any time.

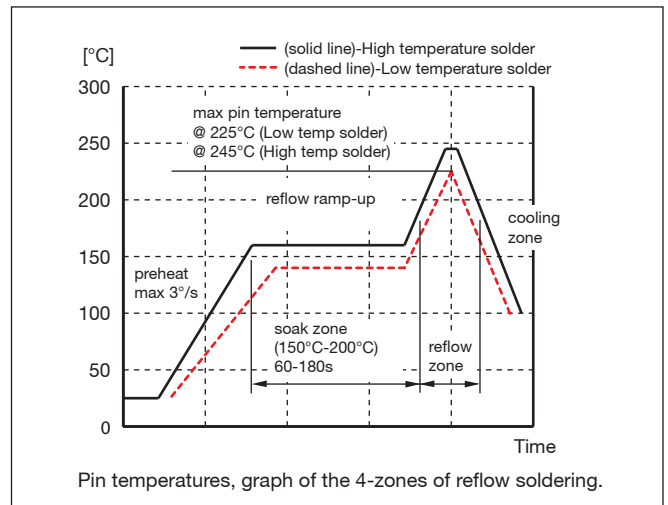

Delivery Package Information

The PMC 8000 series regulators are delivered in antistatic tape & reel (EIA standards 481-2).

Tape & reel specification:

| | |
|----------------------|-------------------|
| Material: | Conductive |
| Tape width: | 44 mm [1.73 in.] |
| Tape pitch: | 24 mm [0.95 in.] |
| Total pocket height: | 9.1 mm [0.36 in.] |
| Reel diameter: | 330 mm [13 in.] |
| Reel capacity: | 200 pieces |
| Full reel weight: | typ. 2.0 kg |

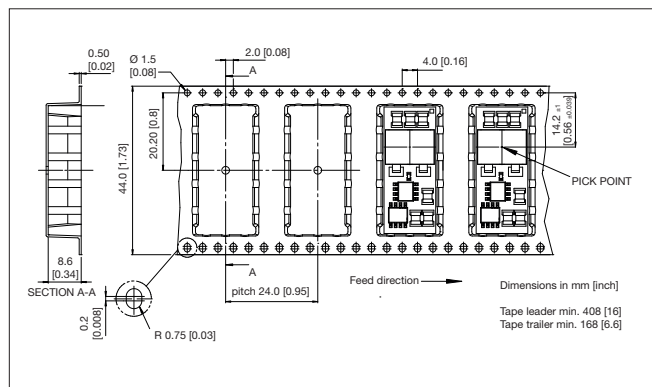

Compatibility with RoHS requirements

The products are compatible with the relevant clauses and requirements of the RoHS directive 2002/95/EC and have a maximum concentration value of 0.1% by weight in homogeneous materials for lead, mercury, hexavalent chromium, PBB and PBDE and of 0.01% by weight in homogeneous materials for cadmium.

Exemptions in the RoHS directive utilized in Ericsson Power Modules products include:

- Lead in high melting temperature type solder (used to solder the die in semiconductor packages)
- Lead in glass of electronics components and in electronic ceramic parts (e.g. fill material in chip resistors)
- Lead as an alloying element in copper alloy containing up to 4% lead by weight (used in connection pins made of Brass)

Reliability

The Mean Time Between Failure (MTBF) of the PMC 8000 series DC/DC regulator family is calculated to be greater than 5 million hours at full output power and a reference temperature of +40 °C using TelCordia SR 332.

Sales Offices and Contact Information

Company Headquarters
Ericsson Power Modules AB
LM Ericssons väg 30
SE-126 25 Stockholm
Sweden

Phone: +46-8-568-69620
Fax: +46-8-568-69599

China
Ericsson Simtek Electronics Co.
33 Fuhua Road
Jiading District
Shanghai 201 818
China

Phone: +86-21-5990-3258
Fax: +86-21-5990-0188

Germany, Austria
Ericsson Power Modules AB
Mühlhauser Weg 18
85737 Ismaning
Germany

Phone: +49-89-9500-6905
Fax: +49-89-9500-6911

Hong Kong (Asia Pacific)
Ericsson Ltd.
12/F. Devon House
979 King's Road
Quarry Bay
Hong Kong

Phone: +852-2590-2453
Fax: +852-2590-7152

Italy, Spain (Mediterranean)
Ericsson Power Modules AB
Via Cadorna 71
20090 Vimodrone (MI)
Italy

Phone: +39-02-265-946-07
Fax: +39-02-265-946-69

Japan
Ericsson Power Modules AB
Kimura Daini Building, 3 FL.
3-29-7 Minami-Oomachi, Shinagawa-ka
Tokyo 140-0013
Japan

Phone: +81-3-5733-5107
Fax: +81-3-5753-5162

North and South America
Ericsson Inc. Power Modules
6300 Legacy Dr.
Plano, TX 75024
USA

Phone: +1-972-583-5254
+1-972-583-6910
Fax: +1-972-583-7839

All other countries
Contact Company Headquarters
or visit our website:
www.ericsson.com/powermodules

Information given in this data sheet is believed to be accurate and reliable.
No responsibility is assumed for the consequences of its use nor for any infringement of patents or other rights of third parties which may result from its use.
No license is granted by implication or otherwise under any patent or patent rights of Ericsson Power Modules. These products are sold only according to Ericsson Power Modules' general conditions of sale, unless otherwise confirmed in writing. Specifications subject to change without notice.

Данный компонент на территории Российской Федерации

Вы можете приобрести в компании MosChip.

Для оперативного оформления запроса Вам необходимо перейти по данной ссылке:

<http://moschip.ru/get-element>

Вы можете разместить у нас заказ для любого Вашего проекта, будь то серийное производство или разработка единичного прибора.

В нашем ассортименте представлены ведущие мировые производители активных и пассивных электронных компонентов.

Нашей специализацией является поставка электронной компонентной базы двойного назначения, продукции таких производителей как XILINX, Intel (ex.ALTERA), Vicor, Microchip, Texas Instruments, Analog Devices, Mini-Circuits, Amphenol, Glenair.

Сотрудничество с глобальными дистрибьюторами электронных компонентов, предоставляет возможность заказывать и получать с международных складов практически любой перечень компонентов в оптимальные для Вас сроки.

На всех этапах разработки и производства наши партнеры могут получить квалифицированную поддержку опытных инженеров.

Система менеджмента качества компании отвечает требованиям в соответствии с ГОСТ Р ИСО 9001, ГОСТ РВ 0015-002 и ЭС РД 009

Офис по работе с юридическими лицами:

105318, г.Москва, ул.Щербаковская д.3, офис 1107, 1118, ДЦ «Щербаковский»

Телефон: +7 495 668-12-70 (многоканальный)

Факс: +7 495 668-12-70 (доб.304)

E-mail: info@moschip.ru

Skype отдела продаж:

moschip.ru

moschip.ru_4

moschip.ru_6

moschip.ru_9