

SPVQA Water-proof Type

Fork terminals allow connection without solder



Detector

Slide

Push

Rotary

Power

Dual-in-line
Package Type

General-
purpose Type

Water-proof
Type

Fast Switching
Type

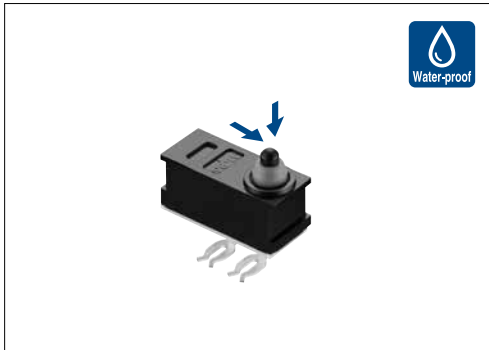

Typical Specifications

Items		Specifications
Rating (max.)/(min.) (Resistive load)		0.1A 12V DC / 50μA 5V DC
Contact resistance (Initial / After operating life)		500mΩ max. / 1Ω max.
Operating force		1±0.5N
Operating life	Without load	300,000cycles
	With load	300,000cycles (0.1A 12V DC)

Product Line

Poles	Positions	Change over timing	Operating part shape	Terminal type	Main body form	Minimum order unit (pcs)		Product No.	Drawing No.	
						Japan	Export			
1	1	Non shorting	Push	Press fit (Without terminal No.3)	Without boss L type	1,200	4,800	SPVQA10103	1	
					Without boss R type			SPVQA10203	2	
				Press fit (Without terminal No.2)	Without boss L type			SPVQA10302	3	
					Without boss R type			SPVQA10402	4	
	Press fit			Without boss L type	SPVQA10504			5		
				Without boss R type	SPVQA10604			6		
	1			2	For PC board (Without terminal No.3)			Without boss	SPVQA20103	7
									For PC board	SPVQA20203

Note

This unit cannot be used in water (IP67 rating, except for terminal).

Packing Specifications

Number of packages (pcs.)		Export package measurements (mm)
1 case /Japan	1 case /export packing	
1,200	4,800	540×360×270

Dimensions

Unit:mm

No.	Style	No.	Style
1	<p>Technical drawing of Style 1 showing dimensions: 15.2, 12.2, 6.4, 0.7, 8.86, 0.7, 3.5, 7.35, 11.48, 2-0.31, 0.8, 3.8, 0.4, 1.8, 90°, 0.4, 1.8, 4.1max., 7.95, 0.7, 0.7, 3.2, 3.2. Labels include: Limit total travel position, Terminal No.①-② ON starting position, Free position, The top of the plunger (Measurement position), Terminal No.③, Terminal No.①, Terminal No.②.</p>	2	<p>Technical drawing of Style 2 showing dimensions: 15.2, 12.2, 6.4, 0.7, 8.86, 0.7, 3.5, 7.35, 11.48, 2-0.31, 0.8, 3.8, 0.4, 1.8, 90°, 0.4, 1.8, 4.1max., 7.95, 0.7, 0.7, 3.2, 3.2. Labels include: Limit total travel position, Terminal No.①-② ON starting position, Free position, The top of the plunger (Measurement position), Terminal No.②, Terminal No.①, Terminal No.③.</p>

■ Dimensions

Unit:mm

No.	Style	No.	Style
3	<p>Technical drawing of style 3 showing dimensions: 15.2, 12.2, 6.4, 0.7, 3.5, 3.22, 11.48, 2-0.31, 3.8, 0.8, 0.4, 1.8, 90°, 4.1max, 7.95, 0.7, 3.6, 3.2, 0.7, 15.2, 12.2, 6.4, 0.7, 3.5, 3.22, 11.48, 2-0.31, 3.8, 0.8, 0.4, 1.8, 90°, 4.1max, 7.95, 0.7, 3.6, 3.2, 0.7. Labels include: Limit total travel position, Terminal No.①-③ OFF starting position, Free position, The top of the plunger (Measurement position), Terminal No.③, Terminal No.①, Terminal No.②.</p>	6	<p>Technical drawing of style 6 showing dimensions: 15.2, 12.2, 6.4, 0.7, 3.5, 3.22, 11.48, 2-0.31, 3.8, 0.8, 0.4, 1.8, 90°, 4.1max, 7.95, 0.7, 3.6, 3.2, 0.7, 15.2, 12.2, 6.4, 0.7, 3.5, 3.22, 11.48, 2-0.31, 3.8, 0.8, 0.4, 1.8, 90°, 4.1max, 7.95, 0.7, 3.6, 3.2, 0.7. Labels include: Limit total travel position, Terminal No.①-② ON starting position, Terminal No.①-③ OFF starting position, Free position, The top of the plunger (Measurement position), Terminal No.③, Terminal No.②, Terminal No.①.</p>
4	<p>Technical drawing of style 4 showing dimensions: 15.2, 12.2, 6.4, 0.7, 3.5, 3.22, 11.48, 2-0.31, 3.8, 0.8, 0.4, 1.8, 90°, 4.1max, 7.95, 0.7, 3.6, 3.2, 0.7, 15.2, 12.2, 6.4, 0.7, 3.5, 3.22, 11.48, 2-0.31, 3.8, 0.8, 0.4, 1.8, 90°, 4.1max, 7.95, 0.7, 3.6, 3.2, 0.7. Labels include: Limit total travel position, Terminal No.①-③ OFF starting position, Free position, The top of the plunger (Measurement position), Terminal No.③, Terminal No.②, Terminal No.①.</p>	7	<p>Technical drawing of style 7 showing dimensions: 15.2, 12.2, 6.4, 0.7, 3.5, 3.22, 11.48, 2-0.31, 3.8, 0.8, 0.4, 1.8, 90°, 4.1max, 7.95, 0.7, 3.6, 3.2, 0.7, 15.2, 12.2, 6.4, 0.7, 3.5, 3.22, 11.48, 2-0.31, 3.8, 0.8, 0.4, 1.8, 90°, 4.1max, 7.95, 0.7, 3.6, 3.2, 0.7. Labels include: Limit total travel position, Terminal No.①-② ON starting position, Free position, The top of the plunger (Measurement position), Terminal No.③, Terminal No.①, Terminal No.②.</p>
5	<p>Technical drawing of style 5 showing dimensions: 15.2, 12.2, 6.4, 0.7, 3.5, 3.22, 11.48, 2-0.31, 3.8, 0.8, 0.4, 1.8, 90°, 4.1max, 7.95, 0.7, 3.6, 3.2, 0.7, 15.2, 12.2, 6.4, 0.7, 3.5, 3.22, 11.48, 2-0.31, 3.8, 0.8, 0.4, 1.8, 90°, 4.1max, 7.95, 0.7, 3.6, 3.2, 0.7. Labels include: Limit total travel position, Terminal No.①-② ON starting position, Terminal No.①-③ OFF starting position, Free position, The top of the plunger (Measurement position), Terminal No.③, Terminal No.①, Terminal No.②.</p>	8	<p>Technical drawing of style 8 showing dimensions: 15.2, 12.2, 6.4, 0.7, 3.5, 3.22, 11.48, 2-0.31, 3.8, 0.8, 0.4, 1.8, 90°, 4.1max, 7.95, 0.7, 3.6, 3.2, 0.7, 15.2, 12.2, 6.4, 0.7, 3.5, 3.22, 11.48, 2-0.31, 3.8, 0.8, 0.4, 1.8, 90°, 4.1max, 7.95, 0.7, 3.6, 3.2, 0.7. Labels include: Limit total travel position, Terminal No.①-② ON starting position, Terminal No.①-③ OFF starting position, Free position, The top of the plunger (Measurement position), Terminal No.③, Terminal No.①, Terminal No.②.</p>

■ Circuit Diagram

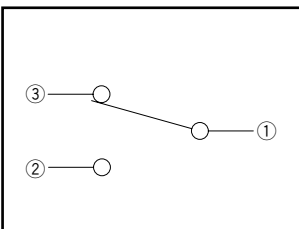

Detector
Slide
Push
Rotary
Power
Dual-in-line Package Type
General-purpose Type
Water-proof Type
Fast Switching Type

Detector

Slide

Push

Rotary

Power

Dual-in-line
Package Type

General-
purpose Type

Waterproof
Type

Fast Switching
Type









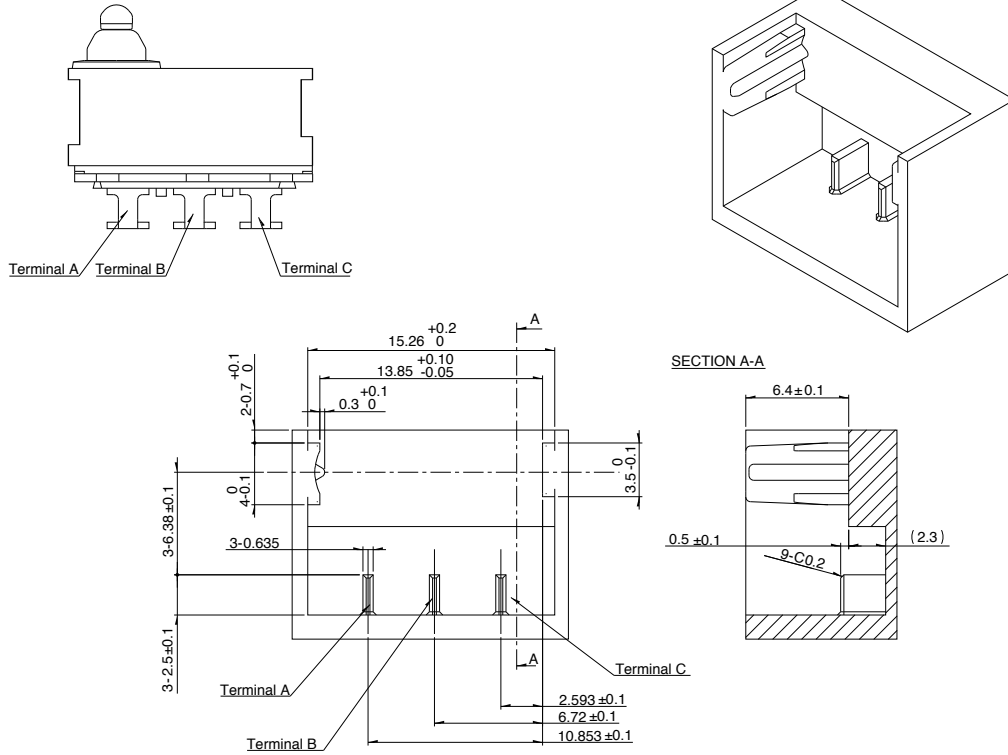

Reference Drawing for Unit Terminals

Unit:mm

Style

SPVQA10504



Series		Water-proof Type			Fast Switching Type	
		SPVQ8	SPVQA	SSCN	SPVQ9	SPVQC
Photo						
Operation type		Two-way				
Dimensions (mm)	W	8.3	15.2	13	15.4	15.4
	D	5.3	6.4	5	8.4	7.4
	H	6.5	7.95	15	7.5	
Operating temperature range		-40°C to +85°C				
Automotive use		●	●	●	●	●
Life cycle (availability)						
Poles / Positions		1/1	1/1 1/2	1/2	2/2	
Rating (max.) (Resistive load)		0.1A 12V DC			50mA 26V DC	50mA 18V DC
Rating (min.) (Resistive load)		50μA 5V DC		100μA 5V DC	50μA 5V DC	
Durability	Operating life without load	300,000cycles 1Ω max. or 1,000,000cycles 3Ω max.	300,000cycles 1Ω max.	100,000cycles 1Ω max.	300,000cycles 200mΩ max.	—
	Operating life with load Rating (max.) (Resistive load)	300,000cycles 1Ω max. or 1,000,000cycles 3Ω max.	300,000cycles 1Ω max.	100,000cycles 1Ω max.	300,000cycles 200mΩ max.	
Electrical performance	Initial contact resistance	500mΩ max.			75mΩ max.	
	Insulation resistance	100MΩ min. 500V DC				100MΩ min. 250V DC
	Voltage proof	500V AC for 1minute				250V AC for 1minute
Mechanical performance	Terminal strength	3N for 1minute (with terminal) Wire strength 30N for 1minute (with wire)	3N for 1minute			
	Actuator strength	20N		10N	20N	
Environmental performance	Cold	-40°C 500h				
	Dry heat	85°C 500h				
	Damp heat	60°C, 90 to 95% RH 500h				
Operation force		1±0.5N		2N max.	1±0.5N	
Page		55	60	63	64	65

Detector Switches Soldering Conditions 66
 Detector Switches Cautions 67

Note
 ● Indicates applicability to all products in the series.

Example of Reflow Soldering Condition

1. Heating method: Double heating method with infrared heater.
2. Temperature measurement: Thermocouple $\phi 0.1$ to 0.2 CA (K) or CC (T) at soldering portion (copper foil surface).
A heat resisting tape should be used for fixed measurement.
3. Temperature profile

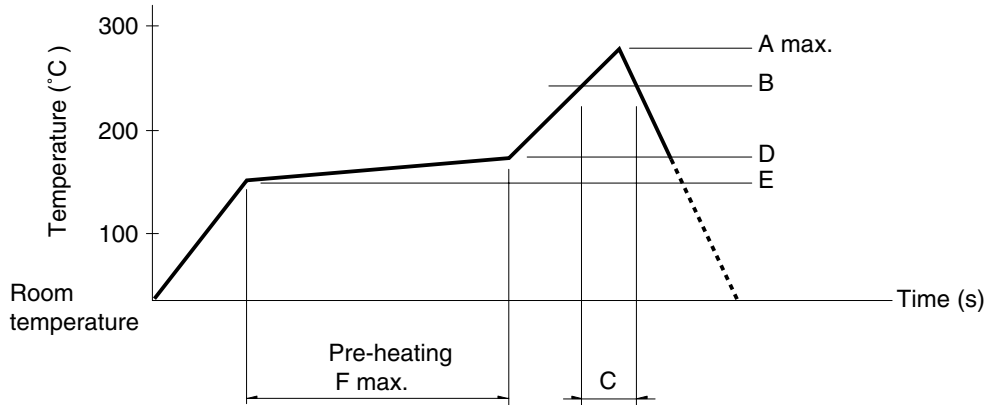

Series (Reflow type)	A (°C) 3s max.	B (°C)	C (s)	D (°C)	E (°C)	F (s)
SPPB	250	230	40	180	150	120
SPVE	260		40			
SPVL						
SPVM						
SPVN						
SPVR						
SPVS						
SPVT						
SSCM						
SSCQ						
SPVQC	250					

Notes

1. The condition mentioned above is the temperature on the mounting surface of a PC board. There are cases where the PC board's temperature greatly differs from that of the switch, surface depending on the PC board's material, size, thickness, etc.
The above-stated conditions shall also apply to switch surface temperatures.
2. Soldering conditions differ depending on reflow soldering machines.
Prior verification of soldering condition is highly recommended.

Reference for Hand Soldering

Series	Soldering temperature	Soldering time
SPVS, SPVN, SPVT, SPVM, SPVR, SPVE, SSCQ, SSCM, SPVL, SSCT, SPVQC	350±5°C	3s max.
SPVQ1, SPVQ3, SPVQ6, SPVQ7, SPVQ8, SPVQ9, SSCN, SPVQA	300±10°C	3 + 1 / 0s
SPPB (Reflow)	300±5°C	5s max.
SSCF, SPPB (For Lead, Dip)	350±10°C	3 + 1 / 0s

Reference for Dip Soldering (For PC board terminal types)

Series	Items		Dip soldering	
	Preheating temperature	Preheating time	Soldering temperature	Duration of immersion
SSCT, SPVQ1, SPVQ3, SPVQ6, SPVQ7, SPVQ8, SPVQ9, SPVQA	100±10°C	60s max.	260±5°C	5±1s
SPPW8, SPPB	100°C max.	60s max.	255±5°C	5±1s
SSCF	—		260±5°C	5±1s

Данный компонент на территории Российской Федерации

Вы можете приобрести в компании MosChip.

Для оперативного оформления запроса Вам необходимо перейти по данной ссылке:

<http://moschip.ru/get-element>

Вы можете разместить у нас заказ для любого Вашего проекта, будь то серийное производство или разработка единичного прибора.

В нашем ассортименте представлены ведущие мировые производители активных и пассивных электронных компонентов.

Нашей специализацией является поставка электронной компонентной базы двойного назначения, продукции таких производителей как XILINX, Intel (ex.ALTERA), Vicor, Microchip, Texas Instruments, Analog Devices, Mini-Circuits, Amphenol, Glenair.

Сотрудничество с глобальными дистрибьюторами электронных компонентов, предоставляет возможность заказывать и получать с международных складов практически любой перечень компонентов в оптимальные для Вас сроки.

На всех этапах разработки и производства наши партнеры могут получить квалифицированную поддержку опытных инженеров.

Система менеджмента качества компании отвечает требованиям в соответствии с ГОСТ Р ИСО 9001, ГОСТ РВ 0015-002 и ЭС РД 009

Офис по работе с юридическими лицами:

105318, г.Москва, ул.Щербаковская д.3, офис 1107, 1118, ДЦ «Щербаковский»

Телефон: +7 495 668-12-70 (многоканальный)

Факс: +7 495 668-12-70 (доб.304)

E-mail: info@moschip.ru

Skype отдела продаж:

moschip.ru

moschip.ru_4

moschip.ru_6

moschip.ru_9