

# PB-Series

## GFCI/ELCI & Panel Seal

The PB-Series utilizes the hydraulic magnetic principle which provides precise operation and performance even when exposed to extremely hot and/or cold application environments.

The new PB-Series, AC Residual Current Circuit Breaker with Overcurrent Protection (RCBO), combines the ground fault protection of a GFCI with the familiar overcurrent tripping characteristics of a normal circuit breaker.

These precision mechanisms are temperature stable and are not adversely affected by temperature changes in their operating environment. As such, derating considerations due to temperature variations are not normally required, and heat-induced nuisance tripping is avoided.

### Features:

- Overload, short circuit and ground fault protection in a single package
- Handle or rocker style actuators
- Wiping Contacts - Mechanical linkage with two-step actuation – cleans contacts, provides high, positive contact pressure & longer contact life.
- A trip-free mechanism, a safety feature which makes it impossible to manually hold the contacts closed during overload or fault conditions.
- A common trip linkage between all poles, another safety feature, ensures that an overload in one pole will trip all adjacent poles.
- Front panel mounting
- Integral push-to-test button



### Benefits:

- Increases safety around boats and marinas
- Protects against electrical shock hazards in areas near water
- Protects against defects in wires & conductors
- Reduces fire and shock hazards from defects in permanently installed appliances such as water heaters, battery chargers, lighting fixtures, etc.
- Detects lower level ground faults which do not trip ordinary circuit breakers, but can lead to fires, and shock hazards for boating occupants



**Carling Technologies™**

Innovative Designs. Powerful Solutions.

**Carling Technologies, Inc.**  
60 Johnson Avenue • Plainville, CT 06062-1177  
Phone: (860) 793-9281 • Fax: (860) 793-9231  
Email: [sales@carlingtech.com](mailto:sales@carlingtech.com) • [www.carlingtech.com](http://www.carlingtech.com)

## Electrical Tables

**Table A:** UL Listed configurations and performance capabilities as Circuit Breakers.

PB-SERIES TABLE A					
CIRCUIT CONFIGURATION	VOLTAGE			CURRENT RATING (AMPS)	INTERRUPTING CAPACITY (AMPS)
	MAX RATING VOLTS	FREQUENCY HERTZ	PHASE		
SERIES	120	60	1	.10-30	5000

## Electrical

Maximum Voltage 120/240VAC 60 Hz  
 Current Ratings Standard current coils: 0.100, 0.250, 0.500, 0.750, 1.00, 2.50, 5.00, 7.50, 10.0, 15.0, 20.0, 25.0 & 30.0 amps. Other ratings available, see ordering scheme.  
 Insulation Resistance Minimum of 100 Megohms at 500 VDC.  
 Dielectric Strength UL, CUL - 1500 V 60 Hz for one minute between all electrically isolated terminals. PB-Series circuit breakers comply with the 8mm spacing and 3750V 60 Hz dielectric requirements from hazardous voltage to operator accessible surfaces and between adjacent poles  
 Impedance Values from Line to Load Terminal.



Ampere Rating

CURRENT (AMPS)	TOLERANCE (%)
0.100 - 5.0	± 15%
5.1 - 20.0	± 25%
20.1 - 30.0	± 35%

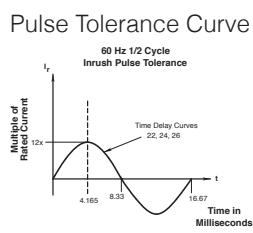

## Leakage To Ground

Standard Must Trip 120/240VAC 60 Hz  
 Leakage Current Ratings 5 & 30 milliamps. 5 ± 1mA for UL943, other leakage ratings test to UL1053.  
 Trip Time For other ratings, consult factory. 300 ms Max. @ 100%, 40ms Max. @ 500% of must trip leakage current.  
 Test Button On unit face along side of actuator.

## Mechanical

Endurance 10,000 ON-OFF operations @ 6 per minute; with rated Current & Voltage.  
 Trip Free All PB-Series Circuit Breakers will trip on overload or ground fault, even when Handle is forcibly held in the ON position.  
 Trip Indication The operating Handle moves positively to the OFF position when an overload or ground fault causes the breaker to trip.

## Physical

Number of Poles 1 - 3 poles, where the third pole is neutral  
 Internal Circuit Config. Series Trip  
 Weight Approximately 65 grams/pole. (2.32 ounces/pole.)  
 Standard Colors Housing- Black; Actuator - See Ordering Scheme.

## Environmental

Designed and tested in accordance with requirements of specification MIL-PRF- 55629 and MIL-STD-202 as follows:  
 Shock Withstands 100 Gs, 6ms, sawtooth while carrying rated current per Method 213, Test Condition "I". Ultra-short curves tested @ 90% of rated current.  
 Vibration Withstands 0.060" excursion from 10-55 Hz, and 10 Gs 55-500 Hz, at rated current per Method 204C, Test Condition A. Instantaneous and ultrashort curves tested at 90% of rated current.  
 Moisture Resistance Method 106D, i.e., ten 24-hour cycles @ + 25°C to +65°C, 80-98% RH.  
 Salt Spray Method 101, Condition A (90-95% RH @ 5% NaCl Solution, 96 hrs).  
 Thermal Shock Method 107D, Condition A (Five cycles @ -55°C to +25°C to +85°C to +25°C).  
 Operating Temperature -35° C to +65° C  
 Corrosion Tested per UL943 FMG Test. 3 weeks @ 30°C 75% RH, 100ppb H2S, 20ppb Cl2, 200ppb NO2

## Agency Certifications

**UL Listed**  
 UL Standard 489 Circuit Breakers, Molded Case, (Guide DIVQ, File E129899)  
 UL Standard 1077 Supplementary Protectors  
 UL Standard 943 Class A Ground Fault Circuit Interrupters  
 UL Standard 1053 Ground Fault Sensing and Relaying Equipment

\*Manufacturer reserves the right to change product specification without prior notice.



**1 SERIES**  
PB

**2 SYSTEM VOLTAGE / POLES**  
**A** 120 VAC single phase, one pole  
**B** 120/240 VAC single phase, two pole  
**C** 120/240 VAC single phase with switched neutral, three pole  
**D** 120 VAC two pole with switched neutral

**3 CIRCUIT**  
**B** Series Trip (Current)

**4 ACTUATOR<sup>1</sup>**  
**Handle**  
**A** one per pole  
**B** one per multipole unit  
**Two Color Curved Visi-Rocker**  
**C** Indicate ON, vertical legend  
**D** Indicate ON, horizontal legend  
**F** Indicate OFF, vertical legend  
**G** Indicate OFF, horizontal legend  
**Single Color Curved Rocker**  
**J** Vertical legend  
**K** Horizontal legend  
**Two Color Flat Visi-Rocker**  
**1** Indicate OFF, vertical legend  
**2** Indicate OFF, horizontal legend  
**Single Color Flat Rocker**  
**3** Vertical legend  
**4** Horizontal legend



**5 FREQUENCY & DELAY**  
**22** 60Hz Short  
**24** 60Hz Medium  
**26** 60Hz Long

**6 CURRENT RATING (AMPERES)**

CODE	AMPERES				
210	0.100	285	0.850	450	5.000
215	0.150	290	0.900	455	5.500
220	0.200	295	0.950	460	6.000
225	0.250	410	1.000	465	6.500
230	0.300	512	1.250	470	7.000
235	0.350	415	1.500	475	7.500
240	0.400	517	1.750	480	8.000
245	0.450	420	2.000	485	8.500
250	0.500	522	2.250	490	9.000
255	0.550	425	2.500	495	9.500
260	0.600	527	2.750	610	10.000
265	0.650	430	3.000	710	10.500
270	0.700	435	3.500	611	11.000
275	0.750	440	4.000	711	11.500
280	0.800	445	4.500	612	12.000

**7 TERMINAL<sup>2</sup>**  
**1<sup>3</sup>** Push-On 0.250 Tab (Q.C.)  
**2** Screw 8-32 w/upturned lugs  
**3** Screw 8-32 (Bus Type)  
**4** Screw 10-32 w/upturned lugs  
**5** Screw 10-32 (Bus Type)  
**B** Screw M5 w/upturned lugs  
**C** Screw M4 w/upturned lugs  
**E** Screw M4 (Bus Type)  
**H** Screw M5 (Bus Type)

**8 ACTUATOR COLOR & LEGEND**

Handle Actuator Color	I-O	ON-OFF	Dual	Rocker Single	Actuator Color Visi-Rocker
White	A	B	1	Black	White
Black	C	D	2	White	N/A
Red	F	G	3	White	Red
Green	H	J	4	White	Green
Blue	K	L	5	White	Blue
Yellow	M	N	6	Black	Yellow
Gray	P	Q	7	Black	Gray
Orange	R	S	8	Black	Orange

**9 MOUNTING/BARRIERS**  
**MOUNTING STYLE**  
**Threaded Insert, 2 per pole**  
**A** 6-32 X 0.195 inches  
**B** ISO M3 x 5mm  
**BARRIERS**  
 yes  
 yes

**10 LEAKAGE CURRENT TRIP LEVEL - MAX. TRIP CURRENT**  
**A** 5 MA (CLASS A GFCI)<sup>3,4,5</sup>  
**E** 30 MA (ELCI)

**11 AGENCY APPROVAL**  
**G** UL489 Listed, CSA Certified  
**C** UL1077  
**I** UL1077/UL1500 Ignition Protected, CSA Certified<sup>6</sup>

**Notes:**  
**1** Actuator Code:  
 A: Handle tie pin spacer(s) and retainers provided unassembled with multi-pole units.  
 B: Handle location as viewed from front of breaker:  
 2 pole - left pole 3 pole - center pole  
**2** Screw Terminals are recommended on ratings greater than 20 amps.  
**3** Available with leakage current trip level - Max trip current code E, and agency approval C.  
**4** 6mA per UL943, available with agency approval code G.  
**5** 30mA per UL1053, available with agency approval codes C & G.  
**6** UL1500 only available with 30MA trip level.



1-POLE 120 VAC VERSION



2-POLE 120/240 VAC VERSION

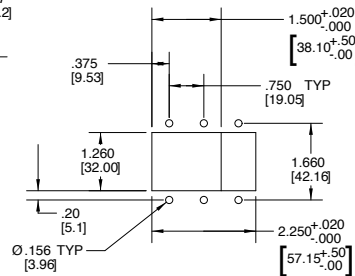

PANEL CUTOUT



2-POLE 120/240 VAC WITH NEUTRAL BREAK

**TERMINAL DIMENSIONAL DETAIL & RATING**

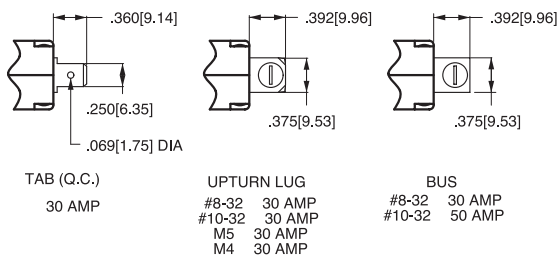

- Notes:  
1 All dimensions are in inches [millimeters].  
2 Tolerance ±.020 [.51] unless otherwise specified.

**TABLE A  
TIGHTENING TORQUE  
SPECIFICATIONS**

THREAD SIZE	TORQUE
#6-32 & M3 MOUNTING HARDWARE	7-9 IN-LBS [0.8-1.0 NM]
#8-32 & M4 THREAD TERMINAL SCREW	12-15 IN-LBS [1.4-1.7 NM]
#10-32 & M5 THREAD TERMINAL SCREW	15-20 IN-LBS [1.7-2.3 NM]

TYPICAL 1-POLE 120 VAC VERSION



TYPICAL 2-POLE 120/240VAC WITH NEUTRAL BREAK VERSION



TYPICAL 2-POLE 120/240 VAC VERSION

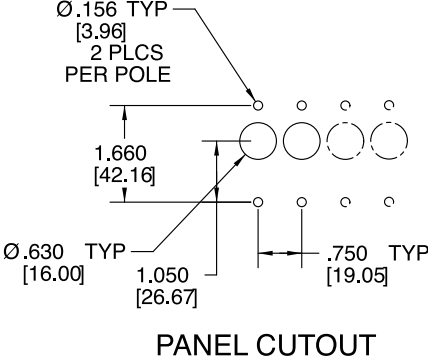
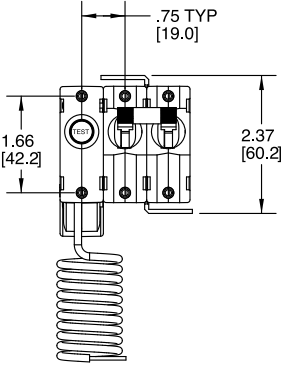
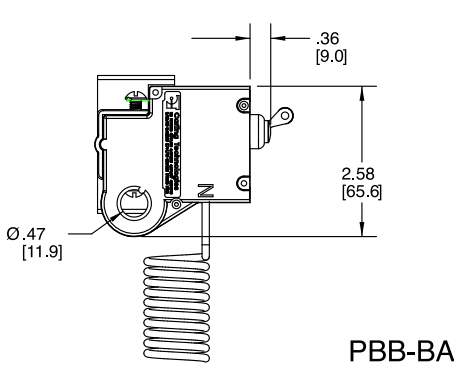

- Notes:
- 1 All dimensions are in inches [millimeters].
  - 2 Tolerance ±.020 [.51] unless otherwise specified.

**120VAC with Switched Neutral**



120 VAC WITH SWITCHED NEUTRAL

**120VAC without Switched Neutral**



120 VAC WITHOUT SWITCHED NEUTRAL

**120/240VAC with Switched Neutral**



120 VAC WITH SWITCHED NEUTRAL

**120/240VAC without Switched Neutral**



120 VAC WITHOUT SWITCHED NEUTRAL



**1 TYPE NUMBER**  
8 Circuit Breaker Assembly

**2 SERIES**  
PB

**3 ACTUATOR TYPE**  
1 Handle, one per pole  
2 Handle, one per multipole unit  
A Rocker<sup>2</sup>

**4 POLES PER UNIT - INCLUDING ELECTRONIC MODULE**  
2 Two  
3 Three  
4 Four

**5 MOUNTING SCREWS / PLATE MATERIAL<sup>1</sup>**  
1 6-32 Thread Phillips Head  
2 M-3 Thread Phillips Head  
3 6-32 Thread Slotted Head  
4 M-3 Thread Slotted Head  
5 6-32 Thread Phillips Head w/ Stainless Steel Plate  
6 M-3 Thread Phillips Head w/ Stainless Steel Plate  
7 6-32 Thread Slotted Head w/ Stainless Steel Plate  
8 M-3 Thread Slotted Head w/ Stainless Steel Plate

Notes:  
1 Screws supplied to accommodate mounting panel thickness of 1/8" ± 1/32". Consult Factory for additional options  
2 Available for Flat and Curved Rocker options - No Rockerguard Bracket

**Handle Style Panel Seal**



**Rocker Style Panel Seal**

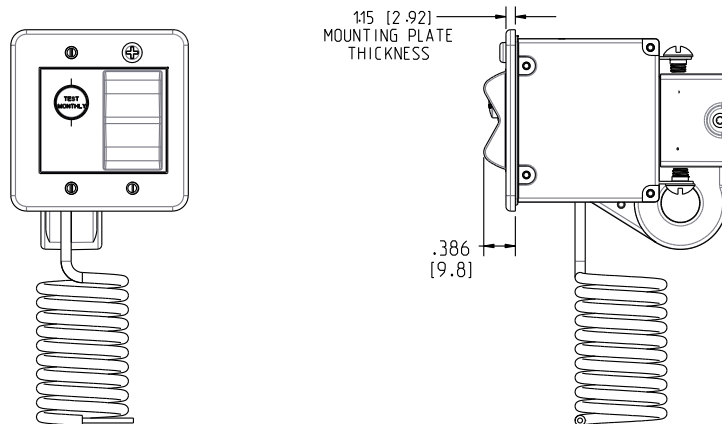

### Handle Actuator



### Rocker Actuator





## Time Delay Curves

### Instantaneous



### Medium



### Short



### Long



## Данный компонент на территории Российской Федерации

### Вы можете приобрести в компании MosChip.

Для оперативного оформления запроса Вам необходимо перейти по данной ссылке:

<http://moschip.ru/get-element>

Вы можете разместить у нас заказ для любого Вашего проекта, будь то серийное производство или разработка единичного прибора.

В нашем ассортименте представлены ведущие мировые производители активных и пассивных электронных компонентов.

Нашей специализацией является поставка электронной компонентной базы двойного назначения, продукции таких производителей как XILINX, Intel (ex.ALTERA), Vicor, Microchip, Texas Instruments, Analog Devices, Mini-Circuits, Amphenol, Glenair.

Сотрудничество с глобальными дистрибьюторами электронных компонентов, предоставляет возможность заказывать и получать с международных складов практически любой перечень компонентов в оптимальные для Вас сроки.

На всех этапах разработки и производства наши партнеры могут получить квалифицированную поддержку опытных инженеров.

Система менеджмента качества компании отвечает требованиям в соответствии с ГОСТ Р ИСО 9001, ГОСТ РВ 0015-002 и ЭС РД 009

### Офис по работе с юридическими лицами:

105318, г.Москва, ул.Щербаковская д.3, офис 1107, 1118, ДЦ «Щербаковский»

Телефон: +7 495 668-12-70 (многоканальный)

Факс: +7 495 668-12-70 (доб.304)

E-mail: [info@moschip.ru](mailto:info@moschip.ru)

Skype отдела продаж:

moschip.ru

moschip.ru\_4

moschip.ru\_6

moschip.ru\_9