

## 600 V high voltage rectifier for BC<sup>2</sup> topology

### Features

- optimized freewheel diode for BC<sup>2</sup> topology (ST patent)
- low conduction losses
- high voltage rectifier
- improves efficiency by up to 2.5% compared to conventional continuous mode PFC using standard ultrafast 600 V PN diodes
- performance efficiency improved by up to 0.5% compared to 600 V Schottky power diodes with no reverse recovery charges used in CCM PFC at 200 kHz
- provides a cost/performance optimized solution to meet the 80+ efficiency requirements
- supports PFC working up to 300 kHz
- suitable for PFC up to 400 W
- compatible with standard PFC controller ICs

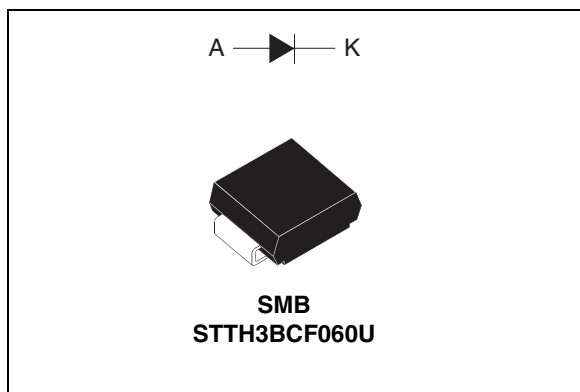

**Table 1. Device summary**

Symbol	Value
$I_{F(AV)}$	3 A
$V_{RRM}$	600 V
$I_R (max)$	100 $\mu$ A
$T_j$	175 °C

### Description

The STTH3BCF060 is a specific freewheel diode used in continuous mode power factor correction working in the BC<sup>2</sup> topology. This diode has been especially designed for the dedicated BC<sup>2</sup> topology. Therefore, its electrical characteristics offer the best possible efficiency with a P-N optimized structured diode. As a result, SMPS efficiency growth up to 2.5% can be produced at an optimized cost.

# 1 Characteristics

**Table 2. Absolute ratings (limiting values)**

Symbol	Parameter	Value	Unit	
$V_{RRM}$	Repetitive peak reverse voltage	600	V	
$I_{F(RMS)}$	Forward rms current	10	A	
$I_{F(AV)}$	Average forward current $\delta = 0.5$	$T_L = 55\text{ }^\circ\text{C}$	3	A
$I_{FSM}$	Surge non repetitive forward current	$t_p = 10\text{ ms sinusoidal}$	45	A
$T_{stg}$	Storage temperature range	- 65 to + 175	$^\circ\text{C}$	
$T_j$	Maximum operating junction temperature	175	$^\circ\text{C}$	

**Table 3. Thermal resistance**

Symbol	Parameter	Maximum	Unit
$R_{th(j-l)}$	Junction to lead	25	$^\circ\text{C/W}$

**Table 4. Static electrical characteristics**

Symbol	Parameter	Test conditions	Min.	Typ.	Max.	Unit
$I_R$	Reverse leakage current	$T_j = 25\text{ }^\circ\text{C}$	$V_R = V_{RRM}$		3	$\mu\text{A}$
		$T_j = 150\text{ }^\circ\text{C}$		15	100	
$V_F$	Forward voltage drop	$T_j = 25\text{ }^\circ\text{C}$	$I_F = 3\text{ A}$		1.7	V
		$T_j = 150\text{ }^\circ\text{C}$		1.0	1.25	

To evaluate the maximum conduction losses use the following equation:

$$P = 1.03 \times I_{F(AV)} + 0.09 I_{F(RMS)}^2$$

**Table 5. Dynamic electrical characteristics**

Symbol	Parameter	Test conditions	Min.	Typ.	Max.	Unit
$t_{rr}$	Reverse recovery time	$T_j = 25\text{ }^\circ\text{C}$	$I_F = 1\text{ A}, V_R = 30\text{ V}$ $di_F/dt = -50\text{ A}/\mu\text{s}$		35	ns
$t_{fr}$	Forward recovery time	$T_j = 25\text{ }^\circ\text{C}$	$I_F = 3\text{ A},$ $di_F/dt = 100\text{ A}/\mu\text{s}$ $V_{FR} = 1.1 \times V_{Fmax}$		100	ns
$V_{FP}$	Forward recovery voltage					10

Figure 1. Conduction losses versus average current

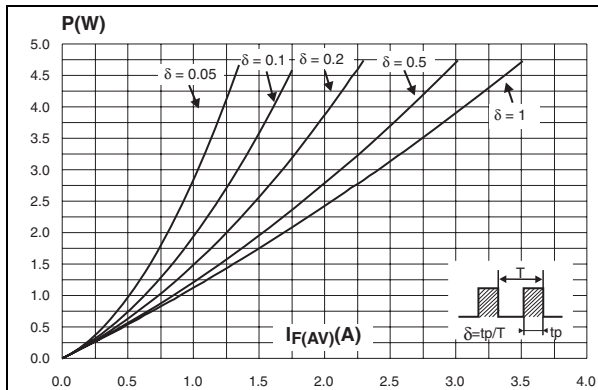

Figure 2. Forward voltage drop versus forward current

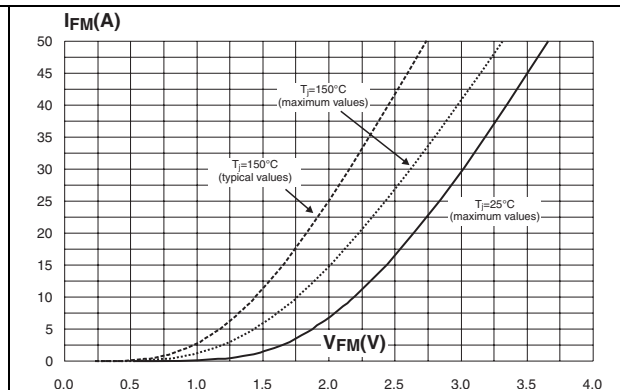

Figure 3. Relative variation of thermal impedance junction ambient versus pulse duration

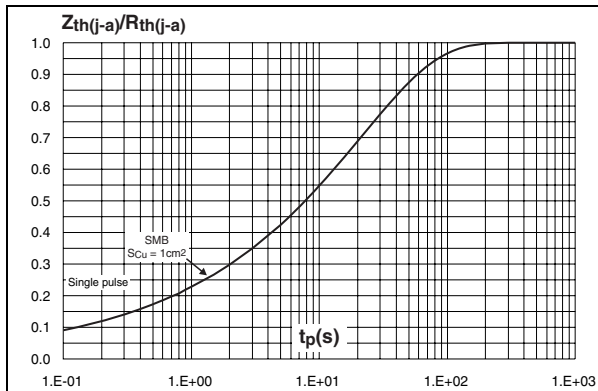

Figure 4. Peak reverse recovery current versus di\_F/dt (typical values)

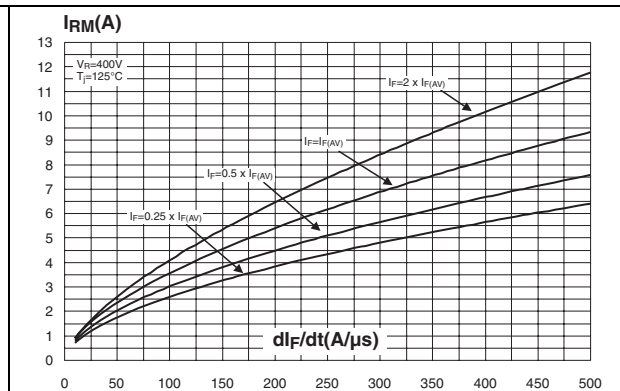

Figure 5. Reverse recovery time versus di\_F/dt (typical values)

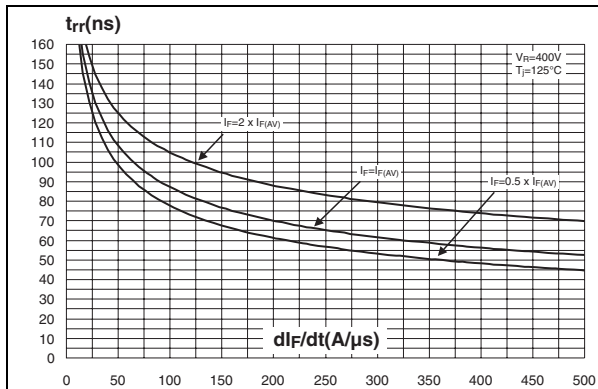

Figure 6. Reverse recovery charges versus di\_F/dt (typical values)

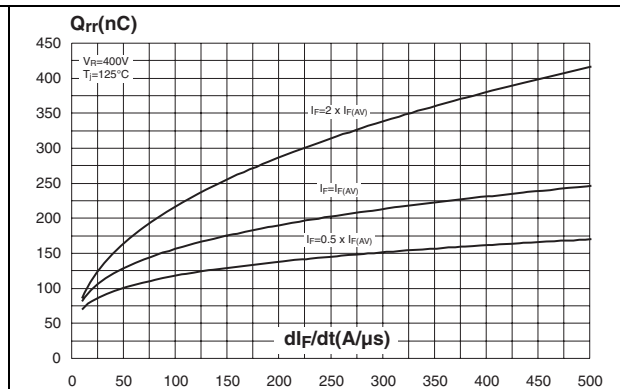

Figure 7. Softness factor versus  $dI_F/dt$  (typical values)

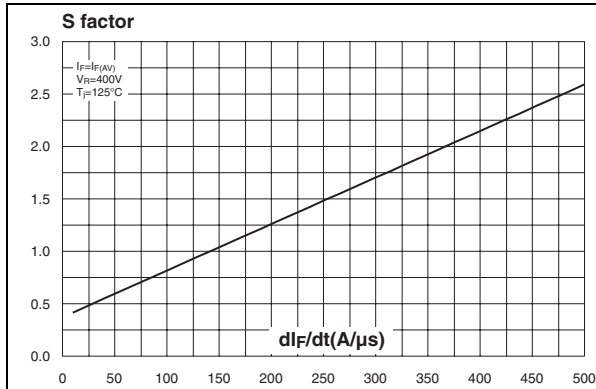

Figure 8. Relative variations of dynamic parameters versus junction temperature

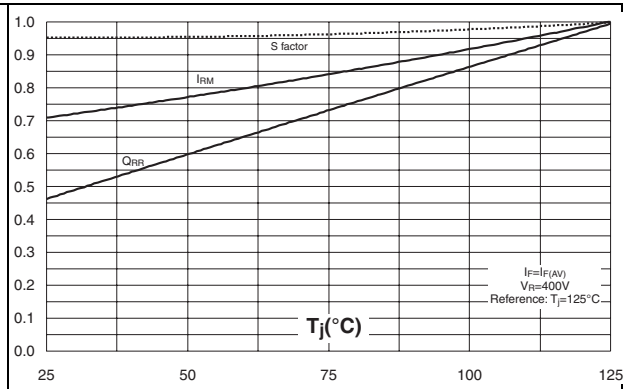

Figure 9. Transient peak forward voltage versus  $dI_F/dt$  (typical values)

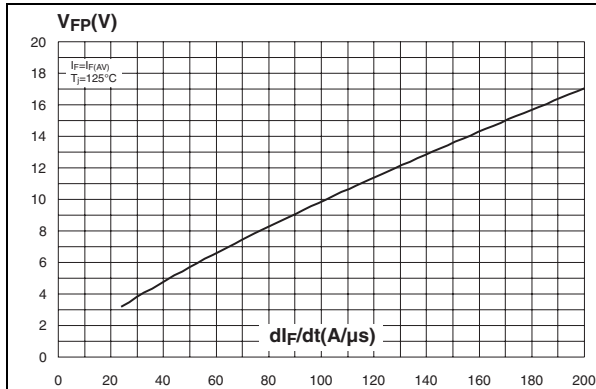

Figure 10. Forward recovery time versus  $dI_F/dt$  (typical values)

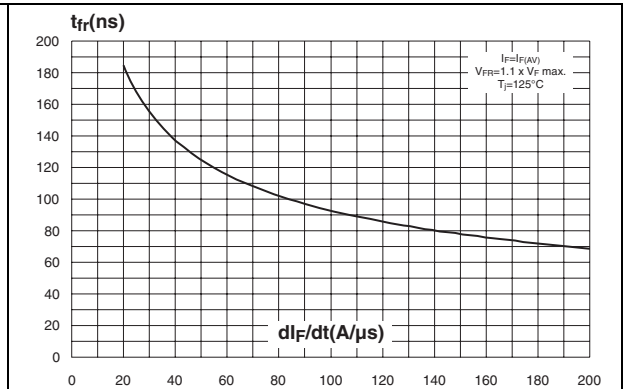

Figure 11. Junction capacitance versus reverse voltage applied (typical values)

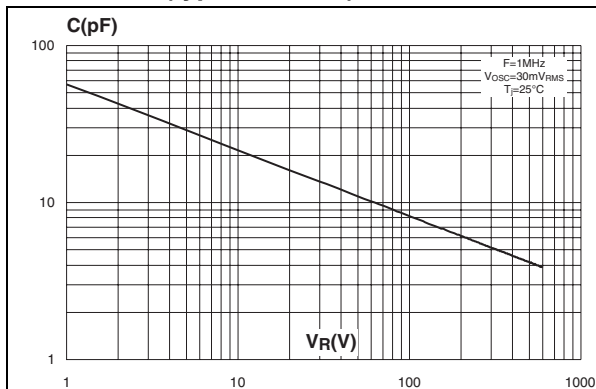
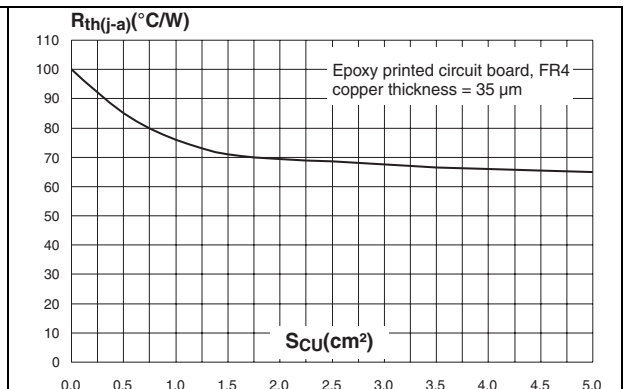
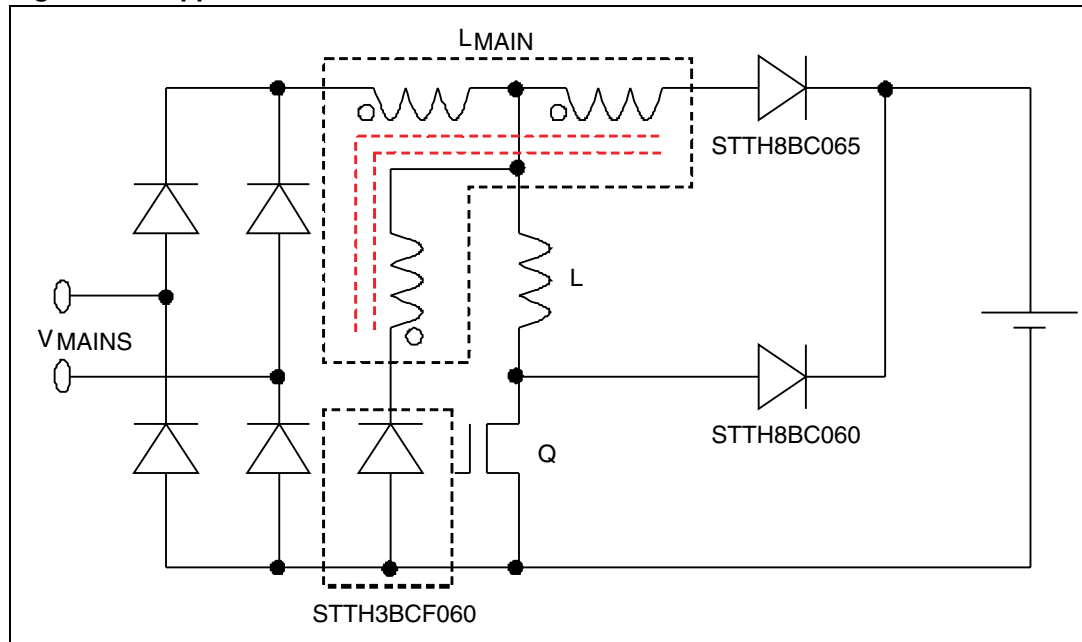

Figure 12. Thermal resistance junction to ambient versus copper surface under lead



## 2 Application information

Figure 13. Application schematic



### 2.1 BC<sup>2</sup> topology description (ST patent)

No hard switching occurs at turn-on with BC<sup>2</sup> topology. Inductor L in series with the power MOS Q configuration suppresses the switch-on losses. Added winding, coupled with the main boost inductor  $L_{main}$ , in series with the STTH3BCF060 freewheel diode brings back both recovery current from the STTH8BC065 and damping current towards the power circuit. Another added winding in series with STTH8BC065 boost diode discharges the nominal current stored in inductor L flowing through STTH8BC060 diode towards output bulk capacitor.

These two added phases compared with conventional continuous mode PFC, bring back the current corresponding to the usual switching losses in the circuit, hence BC<sup>2</sup> (back current circuit).

### 3 Package information

- Epoxy meets UL94, V0
- Lead-free packages

In order to meet environmental requirements, ST offers these devices in different grades of ECOPACK® packages, depending on their level of environmental compliance. ECOPACK® specifications, grade definitions and product status are available at: [www.st.com](http://www.st.com). ECOPACK® is an ST trademark.

**Table 6. SMB dimensions**

Ref.	Dimensions			
	Millimeters		Inches	
	Min.	Max.	Min.	Max.
A1	1.90	2.45	0.075	0.096
A2	0.05	0.20	0.002	0.008
b	1.95	2.20	0.077	0.087
c	0.15	0.40	0.006	0.016
D	3.30	3.95	0.130	0.156
E	5.10	5.60	0.201	0.220
E1	4.05	4.60	0.159	0.181
L	0.75	1.50	0.030	0.059

**Figure 14. Footprint (dimensions in mm)**

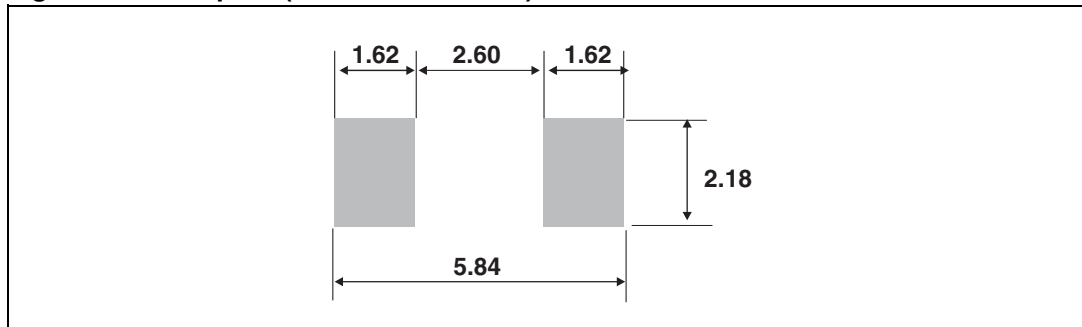

## 4 Ordering information

Table 7. Ordering information

Order code	Marking	Package	Weight	Base qty	Delivery mode
STTH3BCF060U	3BC6	SMB	0.11 g	2500	Tape and reel

## 5 Revision history

Table 8. Document revision history

Date	Revision	Changes
18-May-2010	1	First issue.
28-Oct-2010	2	Updated document title. Modified <a href="#">Section 2.1</a> .

**Please Read Carefully:**

Information in this document is provided solely in connection with ST products. STMicroelectronics NV and its subsidiaries ("ST") reserve the right to make changes, corrections, modifications or improvements, to this document, and the products and services described herein at any time, without notice.

All ST products are sold pursuant to ST's terms and conditions of sale.

Purchasers are solely responsible for the choice, selection and use of the ST products and services described herein, and ST assumes no liability whatsoever relating to the choice, selection or use of the ST products and services described herein.

No license, express or implied, by estoppel or otherwise, to any intellectual property rights is granted under this document. If any part of this document refers to any third party products or services it shall not be deemed a license grant by ST for the use of such third party products or services, or any intellectual property contained therein or considered as a warranty covering the use in any manner whatsoever of such third party products or services or any intellectual property contained therein.

**UNLESS OTHERWISE SET FORTH IN ST'S TERMS AND CONDITIONS OF SALE ST DISCLAIMS ANY EXPRESS OR IMPLIED WARRANTY WITH RESPECT TO THE USE AND/OR SALE OF ST PRODUCTS INCLUDING WITHOUT LIMITATION IMPLIED WARRANTIES OF MERCHANTABILITY, FITNESS FOR A PARTICULAR PURPOSE (AND THEIR EQUIVALENTS UNDER THE LAWS OF ANY JURISDICTION), OR INFRINGEMENT OF ANY PATENT, COPYRIGHT OR OTHER INTELLECTUAL PROPERTY RIGHT.**

**UNLESS EXPRESSLY APPROVED IN WRITING BY AN AUTHORIZED ST REPRESENTATIVE, ST PRODUCTS ARE NOT RECOMMENDED, AUTHORIZED OR WARRANTED FOR USE IN MILITARY, AIR CRAFT, SPACE, LIFE SAVING, OR LIFE SUSTAINING APPLICATIONS, NOR IN PRODUCTS OR SYSTEMS WHERE FAILURE OR MALFUNCTION MAY RESULT IN PERSONAL INJURY, DEATH, OR SEVERE PROPERTY OR ENVIRONMENTAL DAMAGE. ST PRODUCTS WHICH ARE NOT SPECIFIED AS "AUTOMOTIVE GRADE" MAY ONLY BE USED IN AUTOMOTIVE APPLICATIONS AT USER'S OWN RISK.**

Resale of ST products with provisions different from the statements and/or technical features set forth in this document shall immediately void any warranty granted by ST for the ST product or service described herein and shall not create or extend in any manner whatsoever, any liability of ST.

ST and the ST logo are trademarks or registered trademarks of ST in various countries.

Information in this document supersedes and replaces all information previously supplied.

The ST logo is a registered trademark of STMicroelectronics. All other names are the property of their respective owners.

© 2010 STMicroelectronics - All rights reserved

STMicroelectronics group of companies

Australia - Belgium - Brazil - Canada - China - Czech Republic - Finland - France - Germany - Hong Kong - India - Israel - Italy - Japan - Malaysia - Malta - Morocco - Philippines - Singapore - Spain - Sweden - Switzerland - United Kingdom - United States of America

[www.st.com](http://www.st.com)



## Данный компонент на территории Российской Федерации

### Вы можете приобрести в компании MosChip.

Для оперативного оформления запроса Вам необходимо перейти по данной ссылке:

<http://moschip.ru/get-element>

Вы можете разместить у нас заказ для любого Вашего проекта, будь то серийное производство или разработка единичного прибора.

В нашем ассортименте представлены ведущие мировые производители активных и пассивных электронных компонентов.

Нашей специализацией является поставка электронной компонентной базы двойного назначения, продукции таких производителей как XILINX, Intel (ex.ALTERA), Vicor, Microchip, Texas Instruments, Analog Devices, Mini-Circuits, Amphenol, Glenair.

Сотрудничество с глобальными дистрибьюторами электронных компонентов, предоставляет возможность заказывать и получать с международных складов практически любой перечень компонентов в оптимальные для Вас сроки.

На всех этапах разработки и производства наши партнеры могут получить квалифицированную поддержку опытных инженеров.

Система менеджмента качества компании отвечает требованиям в соответствии с ГОСТ Р ИСО 9001, ГОСТ РВ 0015-002 и ЭС РД 009

### Офис по работе с юридическими лицами:

105318, г.Москва, ул.Щербаковская д.3, офис 1107, 1118, ДЦ «Щербаковский»

Телефон: +7 495 668-12-70 (многоканальный)

Факс: +7 495 668-12-70 (доб.304)

E-mail: [info@moschip.ru](mailto:info@moschip.ru)

Skype отдела продаж:

moschip.ru

moschip.ru\_4

moschip.ru\_6

moschip.ru\_9