

MMS / MMT / MMCX / MML series

R209 / R210 / R110 / R302

RADIALL 
The next connexion

Pages

MMS/MMT

Introduction 2-4 to 2-5

Characteristics 2-6 to 2-7

Plugs 2-8

Cable assemblies 2-9

Receptacles 2-9

Accessories and adapters 2-10 to 2-11

Receptacle packaging 2-12

Assembly instructions 2-13

MMCX

Introduction 2-14

Interface 2-14

Characteristics 2-15

Plugs 2-16

Receptacles 2-16 to 2-17

Receptacle packaging and panel drilling 2-18

Assembly instructions 2-19

MML

Introduction 2-20

Characteristics 2-20

Receptacles 2-21

Pigtails 2-21

Cable assemblies 2-21 to 2-22

Adapters 2-22

Tools 2-22

INTRODUCTION

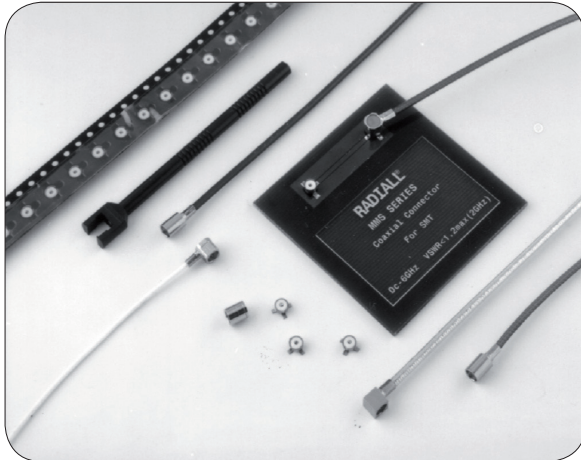

	MMS	MMT
50Ω	DC - 6 GHz	DC - 8 GHz
75Ω	DC - 1 GHz	

GENERAL

- Low profile coaxial connectors
- Surface-mount receptacle (SMT)
- Fully compatible with automated pick and place machines
- Snap-on mating
- High RF performance
- 360° cable rotation

APPLICATIONS

- Wireless base stations
- Satellite reception terminals (GPS...)
- Instrumentation
- Wireless datacom networks
- Automated payment systems
- Videocommunications
- Other general electronics

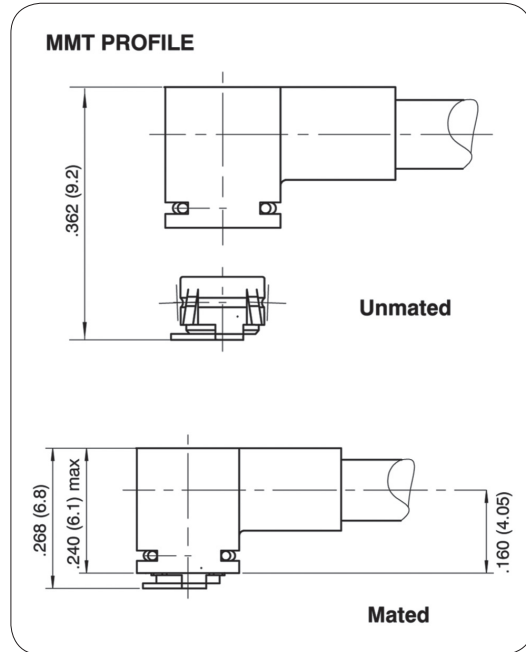
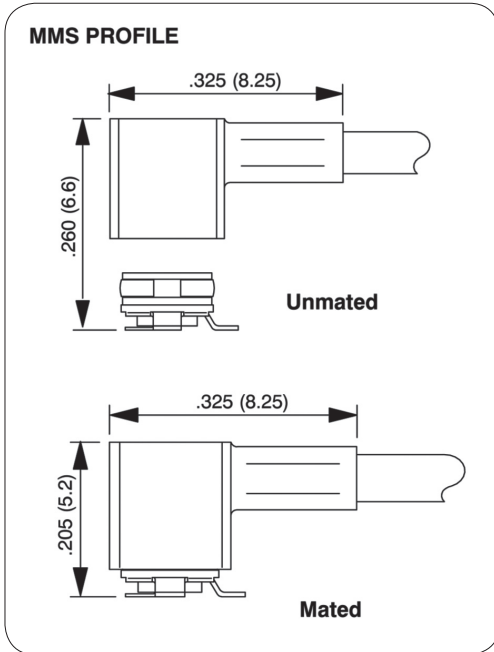

RADIALl has designed a complete range of microminiature coaxial connectors, dedicated to **Surface Technology (SMT)**.

Better than a simple SMT version of standard connector, **MMS** and **MMT** series were the first coaxial designed for SMT applications. Due to its optimized design, **MMS** and **MMT** range benefit from the following advantages:

- **Design adapted to automatic placement**

The assymetric footprint of the **MMS** and **MMT** connectors allows video micro-positionning using the shadow to analyse its placement.

MMS and **MMT** connectors stand on three pliable legs. This design guarantees the receptacle stability placement. It allows it to absorb by elastic bending of the legs, the pressure of the positioning mechanism.

- **A geometry suited to automated picking**

The plain upper surface of **MMS** and **MMT** receptacle facilitates vacuum picking of the component automated distribution system. The geometry allows the use of numerous pneumatic nozzles with various diameters.

- **Optimization of soldering procedure**

MMS and **MMT** connectors materials used resist, without damage, the rapid elevation of temperature during the short time of the solder reflow in an infra-red oven.

- **Packaging**

The **MMS** and **MMT** connectors are packaged on tape and reels containing either 100, 500 or 3 000 The unit cavity geometry is designed for a perfect presentation of the component. The bottom of the cavity This hole facilitates the suction of the component, avoiding the adherence effect and allows the use of for a push rod.

- **360° cable rotation**

The **MMS** and **MMT** snap-on mating system ensures a correct positive connection each time and all connectors (plugs + receptacles) have a design which allows a 360° rotation of the pair when mated.

- **MMS vs MMT**

MMS and **MMT** connectors are dedicated to similar application.

Nevertheless the choice between these to standard will be driven by the following characteristics:

	MMS	MMT	Comment
Durability (mating cycle)	50	500	It is the main difference between these two series. MMS is dedicated to application wich requires only few mating/unmating cycles. MMT provide stronger retention force while allowing more manipulation.
Frequency range	50Ω DC-6 GHz 75Ω DC-1 GHz	50Ω DC-8 GHz 75Ω DC-1 GHz	Both series are fully optimized for either wireless phone frequency range or mobile computing such as bluetooth, Wifi and Wimax.
Mated height	5.2 mm	6.8 mm	

CHARACTERISTICS

	Test standard	Values/remarks
--	---------------	----------------

ELECTRICAL CHARACTERISTICS

		50Ω	75Ω
Impedance		DC - 6 GHz	DC - 1 GHz
Frequency range			
Typical V.S.W.R. (mated pair)	IEC 1169-1	1.05 at 1 GHz 1.15 at 2.5 GHz 1.35 at 6 GHz	
Insertion loss	IEC 1169-1	0.2 dB at 2 GHz	
RF leakage (mated pair)	MIL STD 1344 method 3008	-50 dB at 500 MHz -45 dB at 1 GHz -40 dB at 2 GHz	
Outer contact resistance	NF-C 93050 (I = 40 mA peak)	5 MΩ max	
Center contact resistance	NF-C 93050 (I = 40 mA peak)	15 MΩ max	
Insulation resistance	IEC 1169-1	500 MΩ min (under 250 V RMS)	
Working voltage		50 V RMS	
Testing voltage (V RMS)	IEC 1169-1	Ø 1 mm: 250 ; Ø 2 mm: 500	
Maximum admissible power		40 W at 1 GHz / 20°C / V.S.W.R. = 1	

MECHANICAL CHARACTERISTICS

Durability	IEC 1169-1	50 matings
Force to engage	IEC 1169-1	7 N avg
Force to disengage	IEC 1169-1	5.5 N avg
Shocks (drop test)	IEC 68-2-27	50 g/11 ms ; 3 shocks/axis/way
Random vibrations	General Motors spec.	Sine waves 5 to 1000 Hz 3 to 30g - 1 H/axis
Bumps (mechanical shocks)	IEC 68-2-29	25 g/6 ms 1000 bumps/axis/way
Cable retention force	IEC 1169-1	Ø 1 mm: 20 N ; Ø 2 mm: 35 N
Solderability	IEC 68-2-54	Passed

ENVIRONMENTAL CHARACTERISTICS

Temperature range		-40°C/+90°C
Climatic cycles	GAM T 13	48 H at 70°C - 24 H at 40°C/93% -36 H at -25°C

MATERIALS

Bodies plugs/in-series adapters		Die cast zinc/brass
Bodies receptacles		Phosphor bronze
Center contact	male female	Brass Beryllium copper
Insulator		PTFE

PLATING

Bodies plugs/in series adapters		Nickel
Bodies receptacles		Gold
Center contact	male female	Nickel Gold

RF LEAKAGE AND V.S.W.R

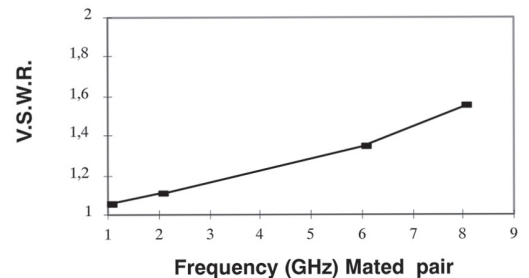
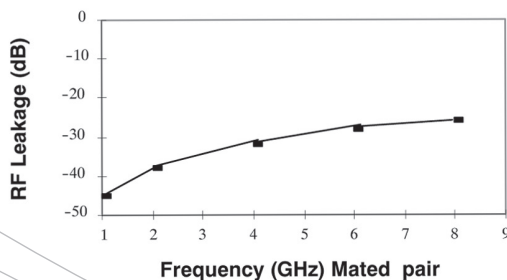

	Test standard	Values/remarks
--	---------------	----------------

ELECTRICAL CHARACTERISTICS

		50Ω	75Ω
Impedance		DC - 8 GHz	DC - 1 GHz
Frequency range			
Typical V.S.W.R. (mated pair)	IEC 1169-1	1.05 at 1 GHz 1.10 at 2.5 GHz 1.15 at 6 GHz	
Insertion loss	IEC 1169-1	≤ 0.2 V F (GHz)	
RF leakage (mated pair)	IEC 1726	-42 dB at 500 MHz -38 dB at 1 GHz -30 dB at 3 GHz	
Outer contact resistance	IEC 1169-1 (I=40 mA eff.)	Initial: 2.5 mΩ max	Final: 12.5 mΩ max
Center contact resistance	IEC 1169-1 (I=40 mA eff.)	Initial: 5 mΩ max	Final: 15 mΩ max
Insulation resistance	IEC 1169-1	≥ 5000 MΩ under 500 Vcc	
Working voltage		170 V eff.	
Testing voltage	IEC 1169-1	500 V eff.	
Maximum admissible power		23 W at 1.8 GHz / 40°C / V.S.W.R. = 1.1	

MECHANICAL CHARACTERISTICS

Durability	IEC 1169-1	500 matings
Force to engage/disengage	IEC 1169-1	Ins ≤ 18 N Ext > 7 N
Shocks	IEC 68-2-27	passed
Vibrations	IEC 68-2-6	passed
Bumps	IEC 68-2-29	passed
Cable retention force	IEC 1169-1	Ø 2 mm: 20 N ; Ø 2.6 mm: 60 N
Solderability	IEC 68-2-29	Passed

ENVIRONMENTAL CHARACTERISTICS

Temperature range		55°C / 100°C
Damp heat	IEC 68-23	Passed
Thermal shocks	IEC 68-2-14 / Test NA	Passed

MATERIALS

Plugs body/in-series adaptor	Brass
Receptacles body	CuSn9p
Plugs center contact	Cube2
Receptacles center contact	Brass
Insulators	PTFE

PLATING

Bodies plugs/in series adapters	Nickel/BBR
Bodies receptacles	Gold
Plugs center contact	Gold
Receptacles center contact	Gold

RF LEAKAGE AND V.S.W.R

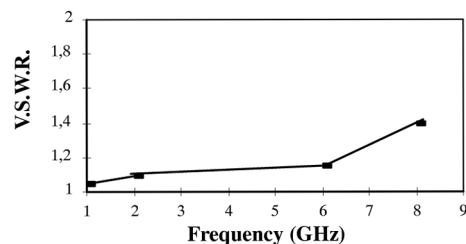
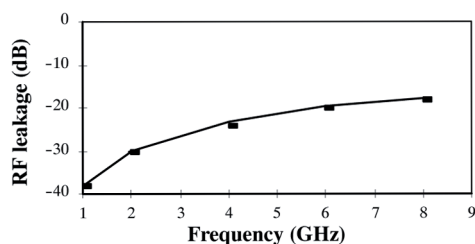

All dimensions are given in mm.

PLUGS AND PIGTAILS

STRAIGHT PLUGS CRIMP TYPE FOR FLEXIBLE CABLES

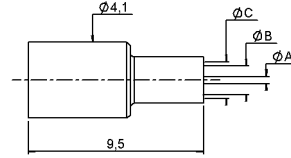
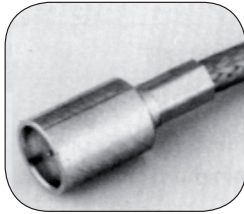

Fig. 1

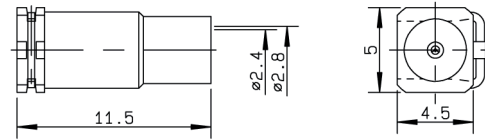

Fig. 2

Series	Cable group	Cable group dia.	Part number	Fig.	Imp. (Ω)	Dimensions (mm)			Captive center contact	Finish
						A	B	C		
MMS	RG178/RG196	2/50/S	R209 080 000	1	50	0.60	1.80	2.25	yes	nickel
MMT	RG174/RG316	2.6/50/S	R210 087 000	2	50				yes	nickel

RIGHT ANGLE PLUGS CRIMP TYPE FOR FLEXIBLE CABLES

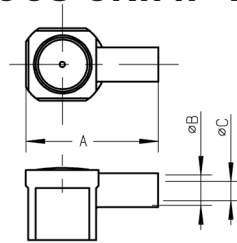

Fig. 1

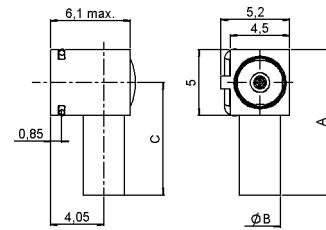

Fig. 2

Series	Cable group	Cable group dia.	Part number	Fig.	Imp. (Ω)	Dimensions (mm)			Captive center contact	Finish
						A	B	C		
MMS		1/50/S	R209 351 020	1	50	7.15	1.28	0.65	yes	nickel
	RG178/RG196	2/50/S	R209 353 000			8.25	2	1.1		
MMT		2/50/S	R210 160 020	2	50	11	3.15	8.5	yes	nickel
	RG174/RG316	2.6/50/S	R210 157 010			10	3.95	7.5		

PIGTAILS

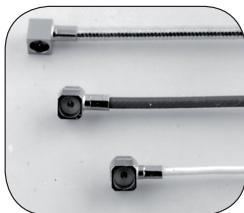

Fig. 1

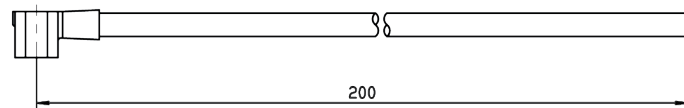
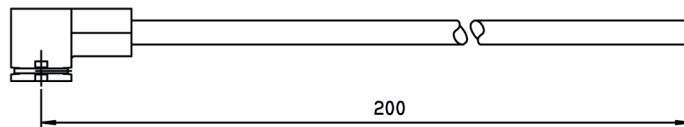

Fig. 2



Series	Cable group	Cable group dia.	Part number	Fig.	Composition
MMS		1/50/S	R285 001 001	1	R209 351 020 + C291 050 066
	RG178/RG196	2/50/S	R285 001 021		R209 353 000 + C291 145 007
MMT		2/50/S	R284 008 001	2	R210 160 020 + C291 145 007
	RG174/RG316	2.6/50/S	R284 008 004		R210 157 010 + C291 150 000

To download data sheets and assembly instructions, visit www.radiall.com & enter the part number in the Search box. **Bold** part numbers represent products typically in stock & available for immediate shipment. See page 8 and 9 for packaging information.

CABLE ASSEMBLIES



Fig. 1

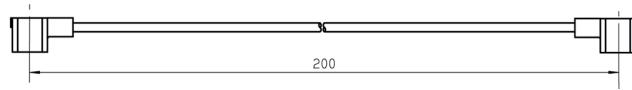
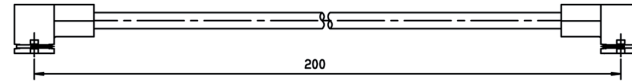
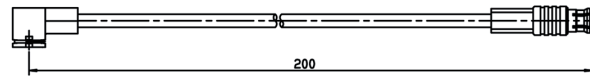
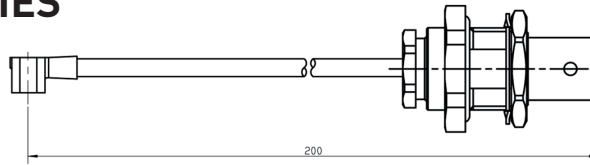
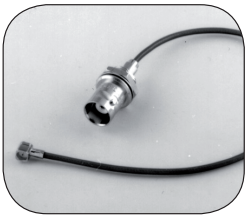

Fig. 2



Series	Cable group	Cable group dia.	Part number	Fig.	Composition
MMS		1/50/S	R285 004 001	1	R209 351 020 + C291 050 066 + R209 351 020
	RG178/RG196	2/50/S	R285 004 221	1	R209 353 000 + C291 145 007 + R209 353 000
MMT	RG178/RG196	2/50/S	R285 011 221	2	R210 160 020 + C291 145 007 + R210 160 020

CUSTOM CABLE ASSEMBLIES



Contact us for all your cable assembly needs.

SMT RECEPTACLES

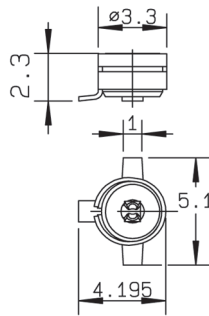
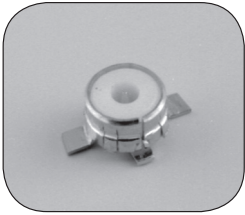

Fig. 1

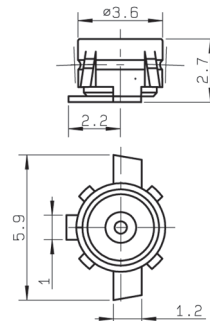

Fig. 2

Series	Part number	Fig.	Imp. (Ω)	Center contact finish	Finish	Packaging	Reel dia.	Assembly instructions
MMS	R209 408 012	1	50	gold	gold	reel 100 pieces	180	M01
	R209 408 052					reel 500 pieces	180	
	R209 408 302					reel 3000 pieces	330	
MMT	R210 408 012	2	50	gold	gold	reel 100 pieces	180	
	R210 408 052					reel 500 pieces	180	
	R210 408 302					reel 3000 pieces	330	

To download data sheets and assembly instructions, visit www.radiall.com & enter the part number in the Search box. **Bold part numbers** represent products typically in stock & available for immediate shipment. See page 8 and 9 for packaging information.

TEST BOARD AND ADAPTERS

BETWEEN SERIES ADAPTERS

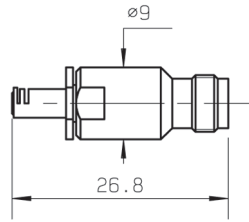
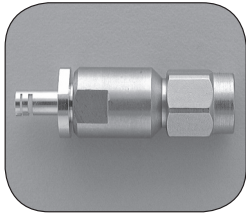

Fig. 1

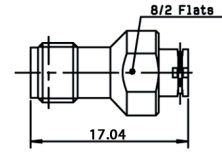

Fig. 2

Series	Part number	Fig.	Type	Finish
MMS	R191 975 791	1	MMS female/SMA female	passivated stainless steel
MMT	R191 394 027	2	MMT female/SMA female	BBR

TEST BOARDS

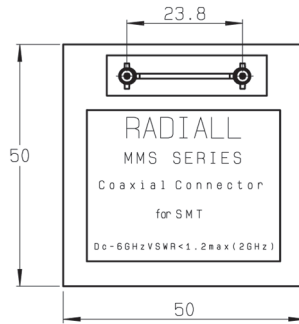
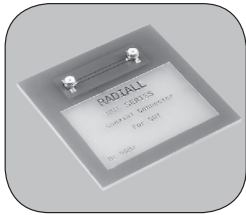

Fig. 1

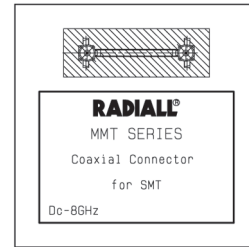

Fig. 2

Series	Part number	Fig.
MMS	R209 900 500	1
MMT	R210 900 500	2

Connected to a network analyzer by 2 cable assemblies, this board allows to measure the V.S.W.R. of a complete link.

IN SERIES ADAPTERS FOR PCB TO PCB LINK

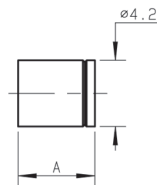

Fig. 1

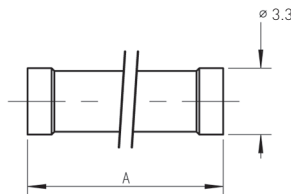

Fig. 2

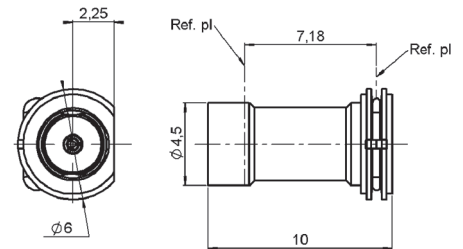
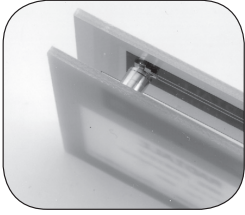

Fig. 3

Series	Part number	Fig.	Dimension A (mm)	Finish	Packaging
MMS	R209 307 000	1	4.9	nickel	100 pieces
	R209 703 070	2	8.01		
MMT	R210 703 507	3		BBR	100 pieces

To download data sheets and assembly instructions, visit www.radiall.com & enter the part number in the Search box. **Bold** part numbers represent products typically in stock & available for immediate shipment. See page 8 and 9 for packaging information.



To ease PCB linking, this adapter is designed to remain mated to one designated PCB. Therefore, the slit interface is slide-on, the other is snap-on. This adapter can also be developed upon request with other lengths, in order to adjust space between PCB (minimum distance: 6.4 mm). Please consult us.

MEASUREMENT CABLE ASSEMBLIES

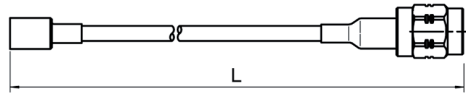

Fig. 1

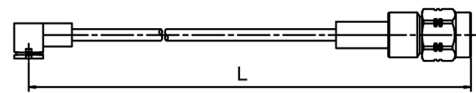
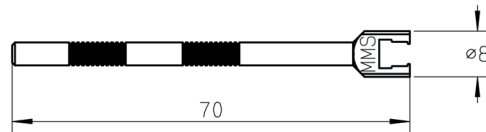
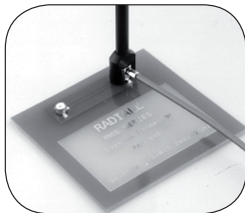

Fig. 2

Series	Cable group	Cable group dia.	Part number	Fig.	Composition	Length L (mm)
MMS ⁽¹⁾	RG178/RG196	2/50/S	R284 007 013	1	R209 080 500 + C291 145 007 + R124 069 120	150
MMT	RD316	2.6/50/D	R285 024 071	2	R210 158 010 + C291 185 067 + R124 072 220	200

⁽¹⁾ Both cable assemblies are equipped with a straight MMS plug with a sliding interface to allow 500 matings and a SMA connector.

EXTRACTION TOOL



Materials and finish: black anodized aluminium
The anodization allows the electric insulation and protects from the oxidization.

Series	Part number
MMS	R282 868 100
MMT	R282 868 030

To download data sheets and assembly instructions, visit www.radiall.com & enter the part number in the Search box.
Bold part numbers represent products typically in stock & available for immediate shipment.
 See page 8 and 9 for packaging information.

RECEPTACLE PACKAGING

ACCORDING TO IEC 286-3 STANDARD

MATERIALS

Reel: polyester

Carrier tape: antistatic PETG (polyester)

Cover tape: polyester

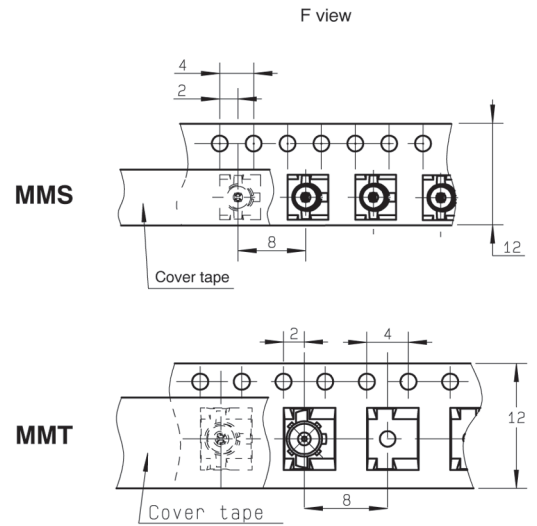
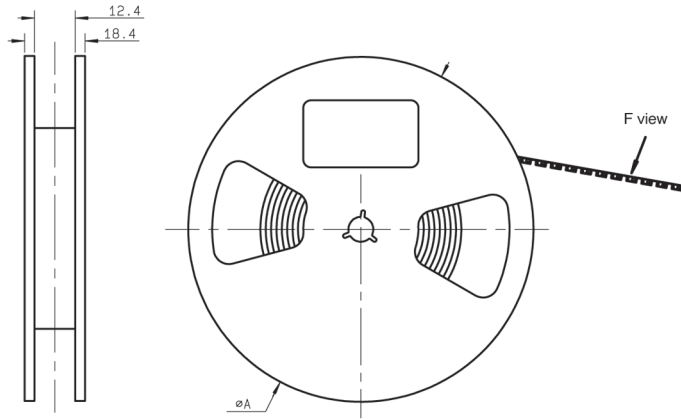

Packaging	Dia. A
100 & 500	180
3000	330

PRECAUTION FOR USE

Automated pick and place machines use standard tooling to peel the antistatic film off. Sometimes the "a" dimension of this tool is shorter than the overall "b" width between the two legs of the receptacle. There is thus a risk for the two legs being deformed while they pass through the tool during the suction operation. The user must then widen the "a" dimension of the peeling tool.

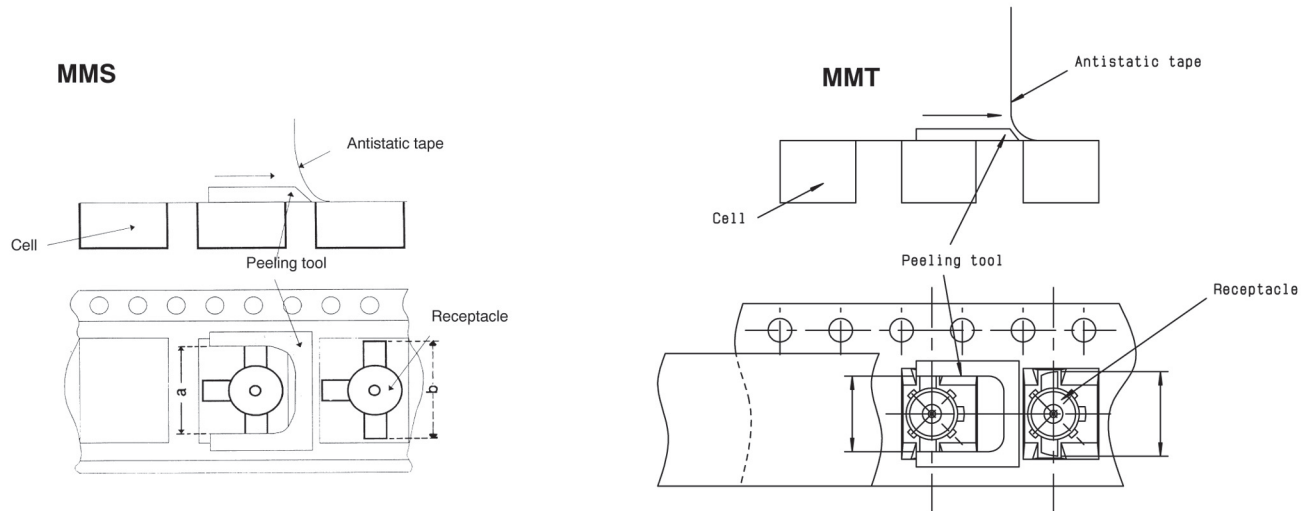

M01

VIDEO SHADOW AND SOLDERING PATTERN OF THE RECEPTACLE

MMS

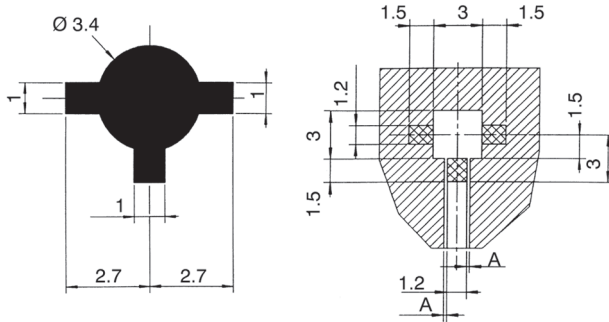

MMT

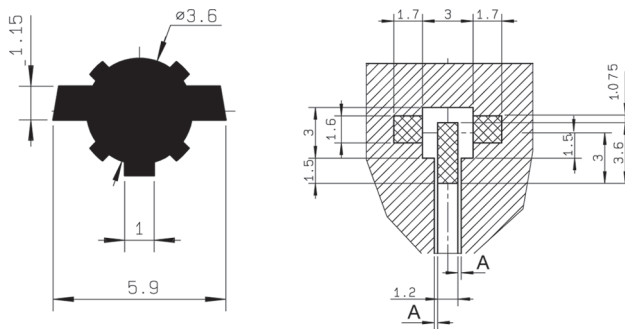

Coplanar circuit on PCB

PCB material: glass epoxy composite ($\epsilon r = 4.6$)
Ground and signal are on the same side.

PCB thickness (mm)	Coplanar line A (mm)
0.8	0.183
1.0	0.190
1.2	0.195
1.6	0.2

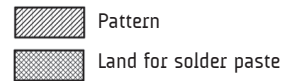

SUCTION PROCEDURE FOR RECEPTACLE

MMS

\emptyset OF NOZZLE > 1.2 mm
Suction with the central contact hole.

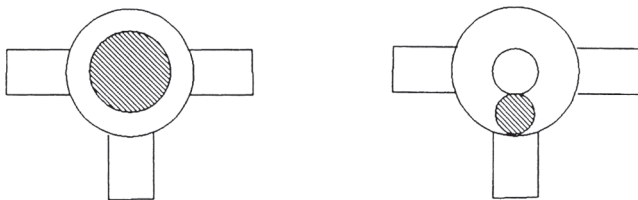

MMT

\emptyset OF NOZZLE < 1.2 mm
Suction with insulator.

ASPIRATION AREA

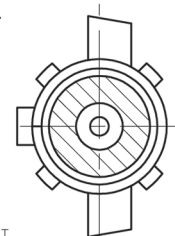

EXAMPLES OF PNEUMATIC NOZZLES

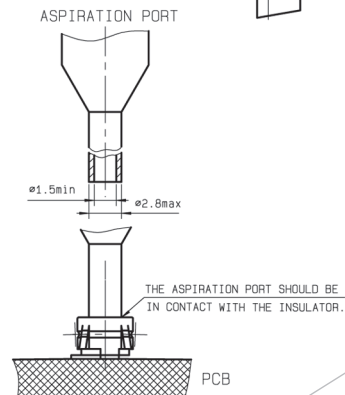
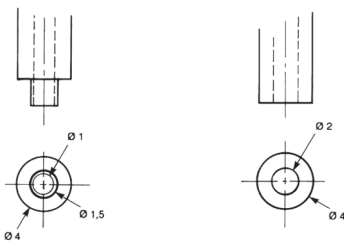

INTRODUCTION

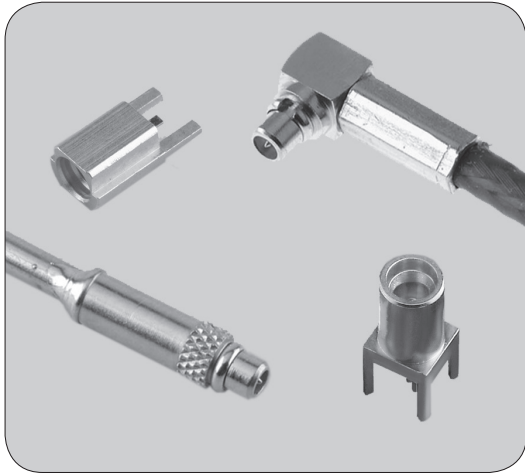

50 Ω	DC - 6 GHz
------	------------

GENERAL

- Subminiature coaxial connectors
- Push-pull" snap-on mating
- Complies with specification CECC 22000

APPLICATIONS

- Wireless LANs
- PCMCIA cards
- RF test ports
- Base stations

MMCX series from Radiall combine intermatability with CECC 22000 compliant suppliers and high manufacturing quality. MMCX series is especially dedicated to wire to PCB connection where low space above the PCB is available (less than 2.1 mm). Due to Radiall manufacturing quality standard, our MMCX provide positive tactile feedback. MMCX series are adapted to high volume applications and Pick & Place manufacturing process.

INTERFACE

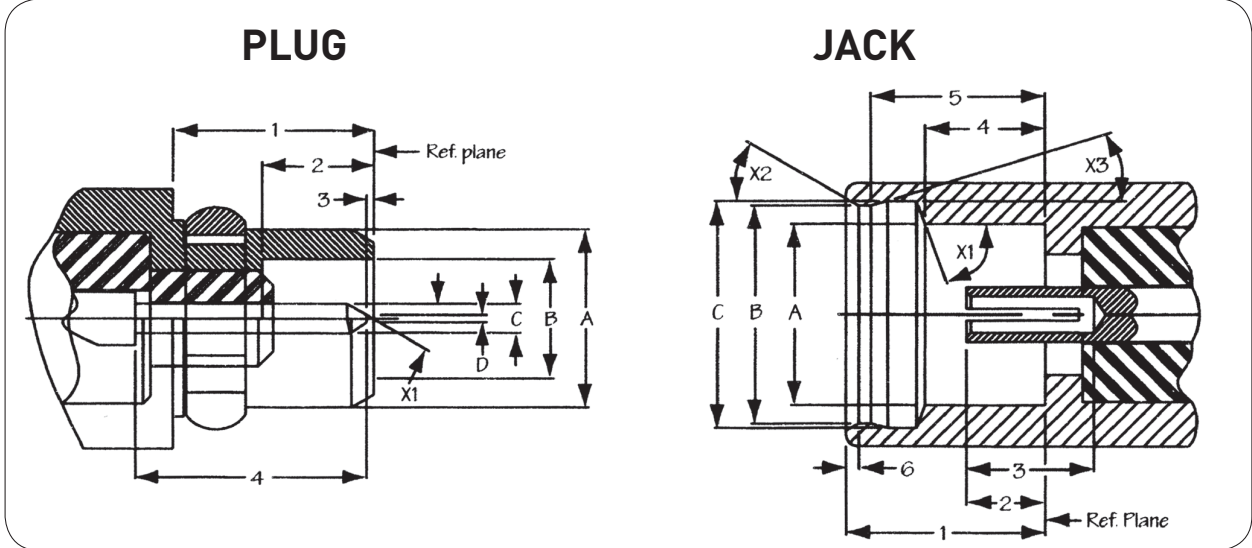

Letter	mm		inch	
	min.	max.	min.	max.
1	2.70		.106	
2	1.45		.057	
3	0	0.25		.010
4		3.15		.124
A	2.40		.095	
B	1.58	1.62	.062	.064
C	0.38	0.42	.015	.017
D		0.20		.008
X1	29°	31°		

Letter	mm		inch	
	min.	max.	min.	max.
1	2.60		.102	
2	0.90	1.20	.035	.047
3	1.40		.055	
4	1.57	1.63	.062	.064
5	2.30	2.34	.091	.092
6		0.23		.009
A	2.41		.095	
B	2.88	2.90	.113	.114
C	3.00	3.04	.118	.120
X1	68°	72°		
X2	28°	32°		
X3	13°	17°		

	Test standard	Values/remarks
--	---------------	----------------

ELECTRICAL CHARACTERISTICS

Impedance		50Ω
Frequency range		DC - 6 GHz
V.S.W.R.	CECC 22000 4.4.1	Edge card SMT: 1.40 max Cabled: 1.35 max
Dielectric withstanding voltage (at sea level)	CECC 22000 4.4.5	500 V RMS 50 Hz
Insulation resistance	CECC 22000 4.4.4	1000 MΩ min

MECHANICAL CHARACTERISTICS

Engagement force	CECC 22000 4.5.4	3.5 lbs max
Disengagement force	CECC 22000 4.5.4	14 lbs to 3.4 lbs max
Contact captivation	CECC 22000 4.5.2	2.3 lbs min
Durability (mating)	CECC 22000 4.7.1	500 cycles min

ENVIRONMENTAL CHARACTERISTICS

Temperature range		-55°C / +155°C
Temperature shock	CECC 22000 4.6.7	compliant
Vibration	CECC 22000 4.6.3	compliant

MATERIALS AND PLATING

	Materials	Platings
Bodies	Brass	Gold
Center contact male female	Brass Beryllium copper	Gold
Insulator	PTFE	

These characteristics are typical and may not apply to all connectors.

CHARACTERISTICS Eco MMCX

ELECTRICAL AND MECHANICAL CHARACTERISTICS

Impedance		50Ω
Frequency range		DC - 3 GHz
Typical VSWR		1.35 at 3 GHz
Temperature range		- 40°C / + 85°C
Mating cycles		100 mating cycles

MATERIALS AND PLATING

	Materials	Platings
Connector body	Brass	Gold
Insulator	PTFE / Polypropylene	
Female center contact	Beryllium copper	Gold
Outer contact	Brass	

PACKAGING

Packaging / MOQ ⁽¹⁾	100 pieces bulk / MOQ 1000 pieces 500 pieces reel / MOQ 1000 pieces 1500 pieces reel / MOQ 1500 pieces Unit packaging / MOQ 100 pieces
--------------------------------	---

⁽¹⁾ MOQ = Minimum Order Quantity

PLUGS AND RECEPTACLES

STRAIGHT PLUGS FULL CRIMP TYPE FOR FLEXIBLE CABLE

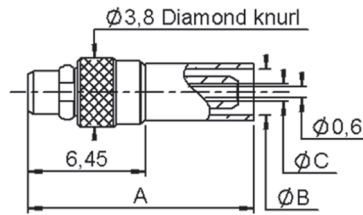

Cable group	Cable group dia.	Part number	Dimensions (mm)			Packaging
			A	B	C	
RG178/RG196	2/50/S	R110 081 020	12.45	2.55	0.97	100
RG174/RG176	2.6/50/S	R110 083 120	13.35	2.95	1.61	

RIGHT ANGLE PLUGS

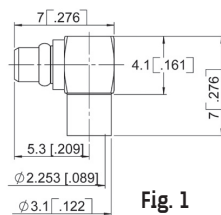
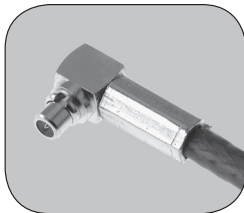

Fig. 1

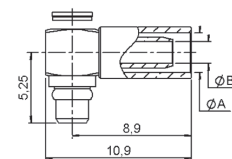

Fig. 2

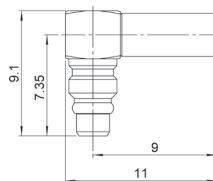

Fig. 3

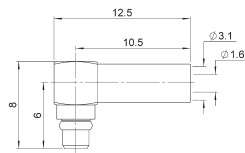

Fig. 4

Cable group	Cable group dia.	Part number	Fig.	Dimensions (mm)		Packaging	Note
				A	B		
RG405	.085"	R110 153 000	1			100	
RG178/RG196	2/50/S	R110 170 100	2	0.97	2.55		ECO version
		R110A 170 100	3				
RG174/RG316	2.6/50/S	R110 172 100	2	1.63	2.95		
		R110A 172 100	4			ECO version	

PCB EDGE CARD RECEPTACLES

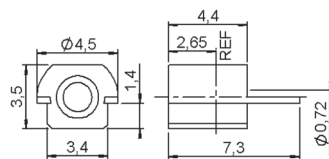

Fig. 1

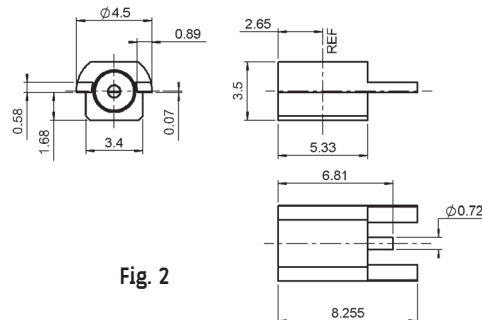

Fig. 2

Part number	Fig.	Gende	Assembly instructions	Packaging	Note
R110 422 100	1	Jack	M04	100	SMT
R110 422 200	2		M05		SMT/offset
R110A 422 830	1		M04	reel of 1500 pieces	ECO version

STRAIGHT PCB RECEPTACLES

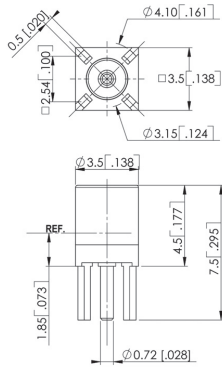

Fig. 1

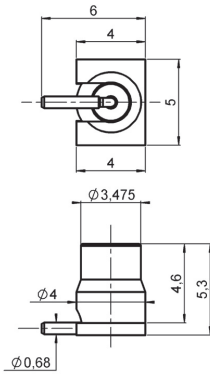

Fig. 2

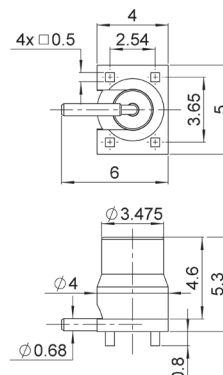

Fig. 3

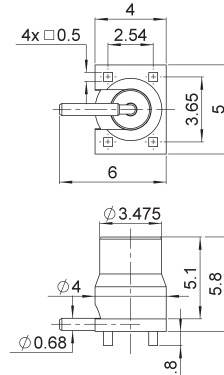
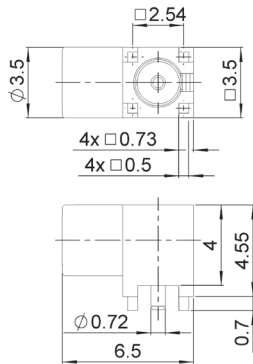

Fig. 4

Part number	Fig.	Gender	Panel drilling	Assembly instructions	Packaging	Note
R110 426 000	1	Jack	P01		100	solder legs
R110A 426 000	1					ECO version
R110 426 097	1					Non magnetic
R110 427 820	2		M02		reel of 500 pieces	SMT
R110 427 830	3					
R110A 427 830	4					ECO version

RIGHT ANGLE FEMALE RECEPTACLE



Part number	Panel drilling	Packaging
R110 665 860	P02	500

RECEPTACLE PACKAGING

ACCORDING TO IEC 286-3 STANDARD

MATERIALS

Reel: polyester

Carrier tape: antistatic PETG (polyester)

Cover tape: polyester

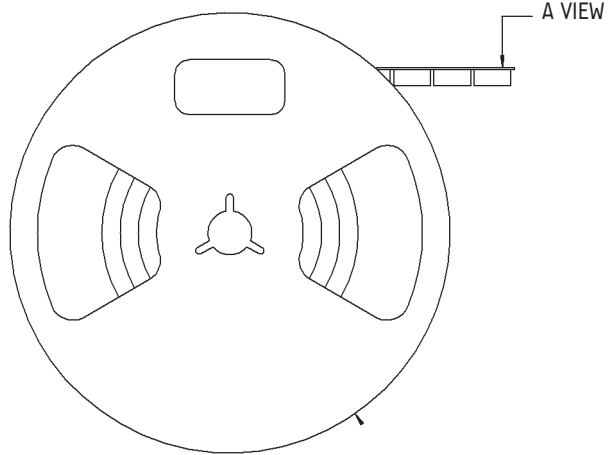

PRECAUTION FOR USE

Automated pick and place machines use standard tooling to peel the antistatic film off. Sometimes the "a" dimension of this tool is shorter than the overall "b" width between the two legs of the receptacle. There is thus a risk for the two legs being deformed while they pass through the tool during the suction operation. The user must then widen the "a" dimension of the peeling tool.

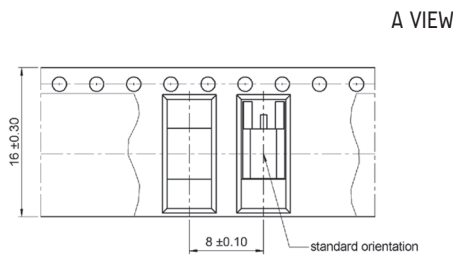

Part number
R110 422 200

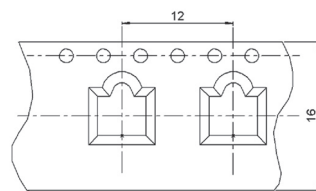

Part number
R110 427 820

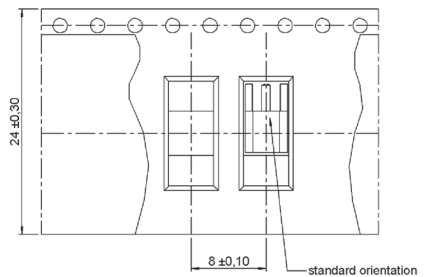

Part number
R110 422 100
R110 422 830

PANEL DRILLING

P01

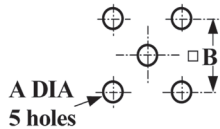

	mm		inch	
	max.	min.	max.	min.
A	0.85	0.75	.033	.030
B	2.56	2.52	.101	.099

P02

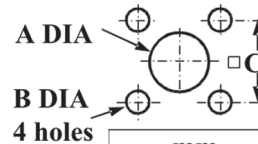

	mm	
	Maxi	mini
A	1.05	0.95
B	0.9	0.8
C	2.56	2.52

M02 SOLDERING PATTERN

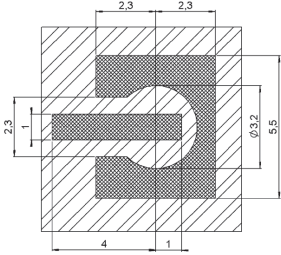

Part number
R110 427 820

- Ground + varnish
- Lands for solder paste

VIDEO SHADOWS

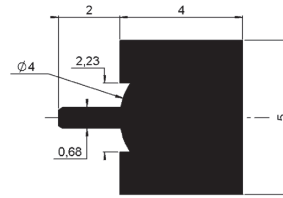

M03 SOLDERING PATTERN

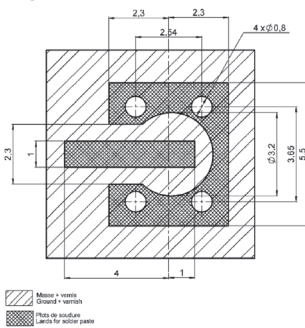

Part number
R110 427 830
R110A 427 830

- Mask + vents
- Ground + vents
- Hole in substrate
- Lands for solder paste

VIDEO SHADOWS

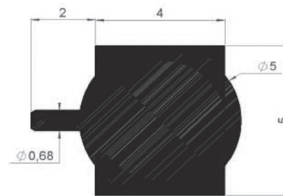

M04 SOLDERING PATTERN

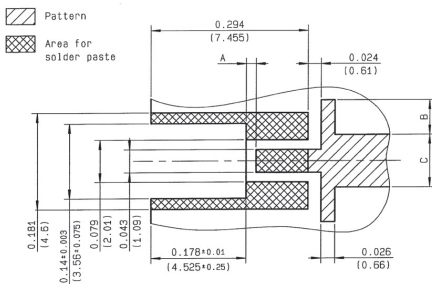

Part number
R110 422 100
R110 422 830

PCB THICKNESS	A	B	C
0.031 (0.79)	0.039 (0.99)	-	0.055 (1.4)
0.039 (0.99)	0.035 (0.89)	0.012 (0.3)	0.071 (1.8)
0.063 (1.6)	0.016 (0.41)	0.063 (1.6)	0.11 (2.79)

VIDEO SHADOWS

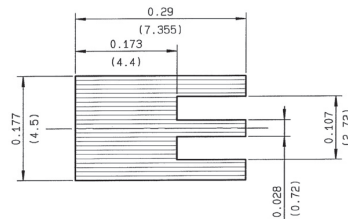

M05 SOLDERING PATTERN

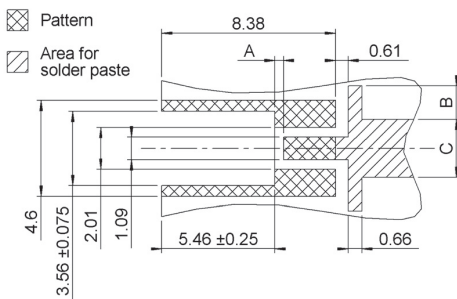

Part number
R110 422 200

PCB THICKNESS	A	B	C
0.79	0.99	-	1.4
0.99	0.89	0.3	1.8
1.6	0.41	1.6	2.79

VIDEO SHADOWS

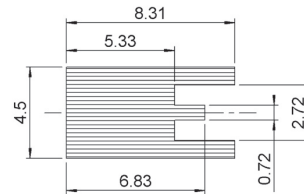

INTRODUCTION

RADIALL has developed a new MML series to address the market demand for smaller microminiature coaxial connectors for applications such as cell relay, WiFi access points, GPS and other mobile terminals. There are three types of plugs with mated heights of, H2.5, H2.0 and H1.5, as well as two types of vertical PCB receptacles with good electrical performance up to 6 GHz.

FEATURES

- Two vertical PCB receptacles
 - MML H2.5 and MML H2.0
 - MML H1.5
- Space saving
 - Three mated heights 2.5 mm, 2.0 mm, 1.5 mm
 - PCB patterns 3.08 mm x 3 mm for H2.5 and H2.0, 2 mm x 2 mm for H1.5
- DC - 6GHz, typical VSWR 1.35 max
- Cable assemblies are offered with three high performance cables: 1.33 mm for MML H2.5, 1.13 mm for MML H2.0, 0.81 mm for MML H1.5

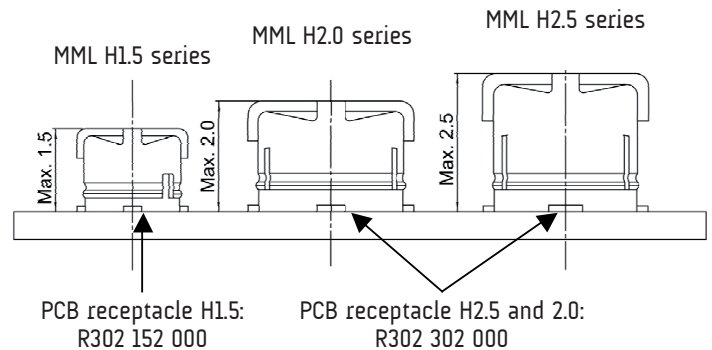

APPLICATIONS

- Handhelds/GPS/WLAN
- GSM/CDMA/WCDMA/TD-SCDMA cards

CHARACTERISTICS

Values/remarks

ELECTRICAL CHARACTERISTICS

Nominal impedance	50 Ω
Frequency range	DC - 6 GHz
Typical VSWR	1.35 max
Contact resistance Center contact Outer contact	25 M Ω 15 M Ω
Insulation resistance	500 M Ω min
Voltage rating H2.5 and H2 H1.5	200 V _{rms} 150 V _{rms}
Withstanding voltage H2.5 and H2 H1.5	300 V _{rms} 200 V _{rms}
Mechanical durability	30 cycles
Center contact axial force	0.15 N
RoHS	Compliant
Temperature range	-40 / +90°C
Humidity	96 hours at temperature of 40°C and humidity of 95%
Corrosion (salt spray)	5% salt water solution, 48 hours

MATERIALS AND PLATING

	Materials	Platings
Connector bodies	Phosphor Bronze	Gold
Female center contact	Phosphor Bronze	Gold
Male center contact	Brass	Gold

SMT RECEPTACLES

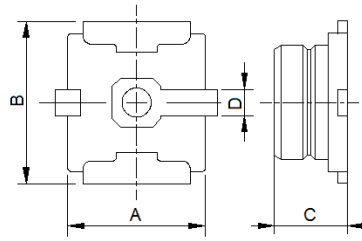

MML type	Part number	Dimensions (mm)				Packaging
		A	B	C	D	
H2.5 & H2.0	R302 302 000	2.6	2.6	1.3	0.6	1000 piece/reel
H1.5	R302 152 000	1.7	1.7	0.85	0.3	2000 piece/reel

MML PIGTAILS

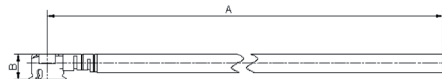

Fig. 1



Fig. 2

Cable group dia.	MML type	Part number	Fig.	Dimensions (mm)		Packaging
				A	B	
1.33/50/S	H2.5	R302 255 003	1	200	1.95	100
1.13/50/S	H2.0	R302 205 001	2		1.44	
0.81/50/S	H1.5	R302 155 000		100	1.2	

MML to MML CABLE ASSEMBLIES

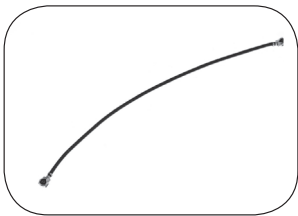

Cable group dia.	MML type	Part number	Dimensions (mm)		Packaging
			A	B	
1.33/50/S	H2.5	R302 000 000	100	1.95	100
1.13/50/S	H2.0	R302 205 000		1.44	
0.81/50/S	H1.5	R302 155 001		1.2	

MML to SMA PLUG CABLE ASSEMBLIES

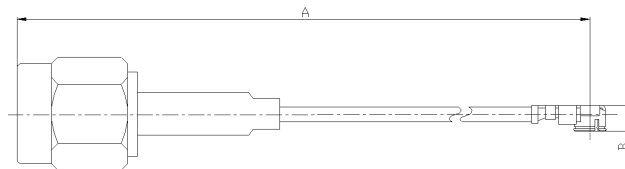

Cable group dia.	MML type	Part number	Dimensions (mm)		Packaging
			A	B	
1.33/50/S	H2.5	R302 255 002	100	1.95	100
1.13/50/S	H2.0	R302 205 002		1.44	

To download data sheets and assembly instructions, visit www.radiall.com & enter the part number in the Search box.

Bold part numbers represent products typically in stock & available for immediate shipment.

See page 8 and 9 for packaging information.

MML to SMA BULKHEAD JACK CABLE ASSEMBLIES

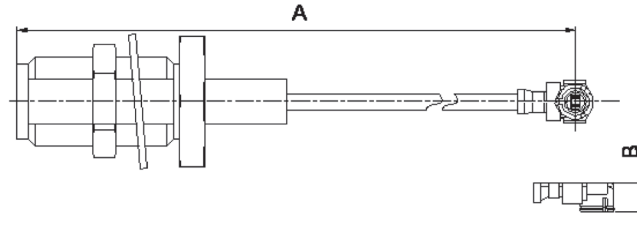
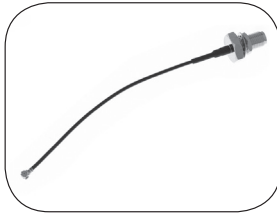

Cable group dia.	MML type	Part number	Dimensions (mm)		Packaging	Note
			A	B		
1.33/50/S	H2.5	R302 255 000	100	1.95	100	Panel sealed SMA
1.33/50/S	H2.5	R302 255 001		1.95		
1.13/50/S	H2.0	R302 205 003		1.44		

ADAPTERS

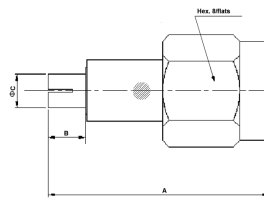
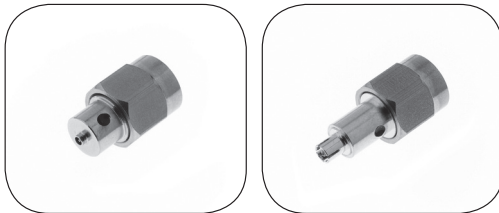

Fig. 1

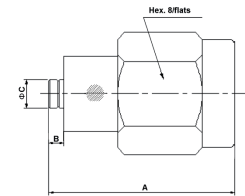

Fig. 2

MML type	Part number	Fig	Dimensions (mm)			Packaging	Note
			A	B	C		
H2.5 & H2.0	R302 303 001	1	17.2	2.9	2.6	unit	MML plug - SMA plug
	R302 303 000	2	13.2	1.05	1.98		MML jack - SMA plug
H1.5	R302 153 000	1	17.2	2.9	2.1		MML plug - SMA plug
	R302 153 001	2	12.9	0.78	1.4		MML jack - SMA plug

EXTRACTION TOOLS



Part number	To disconnect	Packaging
R302 309 000	H2.5 & H2.0	unit
R302 159 000	H1.5	

CABLE CHARACTERISTICS (typical)

Cable	Impedance (Ω)	Cable Dimension mm (inch)					Insertion Loss dB/m (dB/ft)			
		Core type	Core Dia.	Insulator Dia.	Screen	Outer	1 GHz	2 GHz	3 GHz	6 GHz
1.33/50/S	50	7*.102 (7*.004)	.305 (.012) SPC	.88 (.035) FEP	1.13 (.044) TPC	1.33 (.052) FEP	1.61 (0.49)	2.33 (0.71)	2.92 (0.89)	4.31 (1.31)
1.13/50/S	50	7*.08 (7*.003)	.24 (.009) SPC	.70 (.028) FEP	.95 (.037) TPC	1.13 (.044) FEP	2.00 (0.61)	2.90 (0.88)	3.70 (1.13)	5.30 (1.62)
0.81/50/S	50	7*.05 (7*.002)	.15 (.006) SPC	.41 (.016) PFA	.65 (.026) TPC	.81 (.032) PFA	3.00 (0.91)	4.40 (1.34)	5.50 (1.68)	8.30 (2.53)

SPC = Silver Plated Copper TPC = Tin Plated Copper FEP = Fluorinated Ethylene Propylene PFA = Perfluoroalkoxy

To download data sheets and assembly instructions, visit www.radiall.com & enter the part number in the Search box. **Bold** part numbers represent products typically in stock & available for immediate shipment. See page 8 and 9 for packaging information.



AEROSPACE



AUTOMOTIVE



DEFENSE



INDUSTRIAL



INSTRUMENTATION



MEDICAL



SPACE



TELECOM

EUROPE

France - RADIALL S.A.

101, Rue Ph. Hoffmann
93116 ROSNY sous BOIS (Paris)
Tel.: +33 1 49 35 35 35 - Fax: +33 1 48 54 63 63
E-Mail: info@radiall.com

Finland - RADIALL SF

P.O. Box 202 - 90101 OULU
Tel.: +358 407 522 412
E-Mail: infofi@radiall.com

Germany - RADIALL GmbH

Carl-Zeiss Str. 10 Postfach 200143
D63307 - RÖDERMARK (Frankfurt)
Tel.: +49 60 74 91 07 0 - Fax: +49 60 74 91 07 70
E-Mail: infode@radiall.com

Italy - RADIALL Elettronica S.R.L.

Via Concordia, 5 - 20090 ASSAGO MILANO
Tel.: +39 02 48 85 121 - Fax: +39 02 48 84 30 18
E-Mail: infoit@radiall.com
Regional office: Roma

Netherlands - RADIALL B.V.

Hogebrinkerweg 15b - 3871 KM HOEVELAKEN
Tel.: +31 33 253 40 09 - Fax: +31 33 253 45 12
E-Mail: infofl@radiall.com

Sweden - RADIALL A.B.

Sjöängsvägen 2 - SE-192 72 SOLLENTUNA (Stockholm)
Tel.: +46 844 434 10 - Fax: +46 875 449 16
E-Mail: infose@radiall.com

U.K. - RADIALL Ltd.

Ground Floor, 6 The Grand Union Office Park,
Packet Boat Lane
UXBRIDGE Middlesex UB8 2GH (London)
Tel.: +44 1895 425 000 - Fax: +44 1895 425 010
E-Mail: infouk@radiall.com

NORTH AMERICA

USA - RADIALL USA, Inc.

6825 West Galveston Street
CHANDLER, Arizona 85226
Tel.: +1 480 682 9400 - Fax: +1 480 682 9403
E-Mail: infousa@radiall.com

ASIA

China - SHANGHAI RADIALL Electronic Co., Ltd.

N° 390 Yong He Road 200072 - SHANGHAI
Tel.: +86 21 66 52 37 88 - Fax: +86 21 66 52 11 77
E-Mail: infosh@radiall.com

Japan - NIHON RADIALL

Shibuya-ku Ebisu 1-5-2, Kougetsu Bldg 405
TOKYO 150-0013
Tel.: +81 3 3440 6241 - Fax: +81 3 3440 6242
E-Mail: infojp@radiall.com

Hong Kong - RADIALL Electronics Ltd.

Flat D, 6/F, Ford Glory Plaza,
37-39 Wing Hong Street
Cheung Sha Wan
KOWLOON HONG KONG
Tel: +852-2959-3833 - Fax: +852-2959-2636
E-Mail: infohk@radiall.com

India - RADIALL India Pvt. Ltd.

25 D, II Phase, Peenya Industrial Area
BANGALORE 560058
Tel.: +91 80 83 95 271 - Fax: +91 80 83 97 228
E-Mail: infoin@radiall.com

ALSO REPRESENTED IN

Australia	Hungary	Poland
Austria	Indonesia	Russia
Belgium	Israel	Singapore
Brazil	Korea	Spain
Czech Republic	Latvia	Switzerland
Denmark	Lithuania	Taiwan
Estonia	Malaysia	Thailand
Greece	Norway	Vietnam
	Philippines	South Africa

For the above countries, please contact the local agent or RADIALL at info@radiall.com

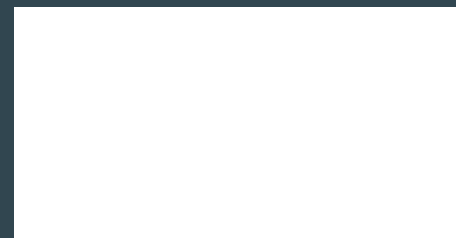

Данный компонент на территории Российской Федерации

Вы можете приобрести в компании MosChip.

Для оперативного оформления запроса Вам необходимо перейти по данной ссылке:

<http://moschip.ru/get-element>

Вы можете разместить у нас заказ для любого Вашего проекта, будь то серийное производство или разработка единичного прибора.

В нашем ассортименте представлены ведущие мировые производители активных и пассивных электронных компонентов.

Нашей специализацией является поставка электронной компонентной базы двойного назначения, продукции таких производителей как XILINX, Intel (ex.ALTERA), Vicor, Microchip, Texas Instruments, Analog Devices, Mini-Circuits, Amphenol, Glenair.

Сотрудничество с глобальными дистрибьюторами электронных компонентов, предоставляет возможность заказывать и получать с международных складов практически любой перечень компонентов в оптимальные для Вас сроки.

На всех этапах разработки и производства наши партнеры могут получить квалифицированную поддержку опытных инженеров.

Система менеджмента качества компании отвечает требованиям в соответствии с ГОСТ Р ИСО 9001, ГОСТ РВ 0015-002 и ЭС РД 009

Офис по работе с юридическими лицами:

105318, г.Москва, ул.Щербаковская д.3, офис 1107, 1118, ДЦ «Щербаковский»

Телефон: +7 495 668-12-70 (многоканальный)

Факс: +7 495 668-12-70 (доб.304)

E-mail: info@moschip.ru

Skype отдела продаж:

moschip.ru

moschip.ru_4

moschip.ru_6

moschip.ru_9