

GENERAL SPECIFICATIONS

Electrical Capacity

Resistive Load: 15A & ½ HP @ 125 or 250V AC for high capacity models
Lamp Load: 5A @ 125V AC

Other Ratings

Contact Resistance: 15 milliohms maximum
Insulation Resistance: 100 megohms minimum @ 500V DC
Dielectric Strength: 1,000V AC minimum between contacts for 1 minute minimum;
 1,500V AC minimum between contacts & case for 1 minute minimum
Mechanical Life: 1,000,000 operations minimum
Electrical Life: 50,000 operations minimum
Travel: Pretravel .047" (1.19mm); Overtravel .040" (1.01mm); Differential .011" (0.27mm)
Operating Temp Range: -40°C through +85°C (-40°F through +185°F)

Materials & Finishes

Caps & Shrouds: Polycarbonate with glossy finish or PBT
Plunger: Polyacetal or brass with nickel plating
Bushing: Steel with zinc plating or glass fiber reinforced polyamide
Case: Polyester
Movable & Stationary Contacts: Silver alloy
Terminals: Brass with silver plating

Standards & Certifications

UL: Internal snap switch is UL recognized.
CSA: Internal snap switch is CSA certified.

TYPICAL SWITCH ORDERING EXAMPLE

SCB **2** **5** **P** **15** **A** — **4** **CA**

Poles	
1	SPDT
2	DPDT

Circuits		
5	ON	(ON)
6	ON	ON
() = Momentary		

Bushings	
P	Plastic (with momentary only)
S	Steel

Rating	
15	15A

Terminals	
A	.187" (4.75mm) Quick Connect
* B	.250" (6.35mm) Quick Connect
Note: Contact factory for availability of screw lug and solder lug models.	
* Available in Americas only	

Caps & Shrouds	
For Momentary	
3	.520" (13.2mm) Diameter Cap
For Momentary & Alternate Action	
4	Round Cap & Shroud (AT454 & AT455)
5	Rectangular Cap & Shroud (AT452 & AT453)

Colors		
	Caps	Shrouds
A	Black	A
B	White	B
C	Red	-
F	Green	-
G	Blue	-
H	Gray	H

DESCRIPTION FOR TYPICAL ORDERING EXAMPLE

SCB25P15A-4CA

Round Red Cap with Black Shroud
 Plastic Bushing
 DPDT ON-(ON) Circuit
 15A Rating
 .187" (4.75mm) Quick Connect Terminals

Note: Standard hardware is provided with caps. See Bushing detail for more information.

Toggles

Rockers

Pushbuttons

Illuminated PB

Keylocks

Rotaries

Slides

Tactiles

Tilt





Touch

Indicators

Accessories

Supplement

POLES & CIRCUITS

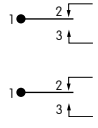
		Plunger Position () = Momentary		Connected Terminals		Throw & Schematics
Pole	Model	Normal  Keyway	Down 	Normal  Keyway	Down 	Note: Terminal numbers are actually on the switch.
SP	SCB15 SCB16	ON ON	(ON) ON	1-2	1-3	
DP	SCB25 SCB26	ON ON	(ON) ON	1-2 1-2	1-3 1-3	SP with 2 switches 

BUSHINGS

P Plastic
(for Momentary only)

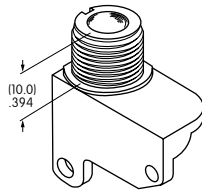

S Steel

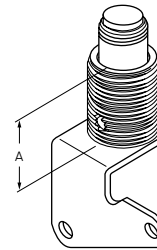

"A" =
11.2mm
Momentary
15.5mm
Alternate Action

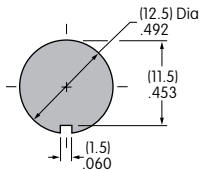

Maximum Effective Panel Thickness:
.165" (4.2mm) without Shroud
.157" (4.0mm) with Shroud

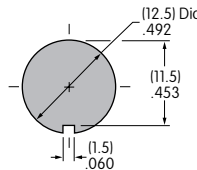

Maximum Effective Panel Thickness:
Momentary: .177" (4.5mm) without Shroud
.157" (4.0mm) with Shroud
Alternate Action: .354" (9.0mm)

Standard Hardware Provided with Caps

Cap Option 3: AT504M Knurled Face Nut, AT508 Lockwasher, AT527M Hex Mounting Nut

Cap Options 4 & 5: AT508 Lockwasher & AT527M Hex Mounting Nut

TERMINALS

A .187" (4.75mm)
Quick Connect

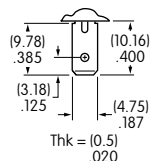

B .250" (6.35mm)
Quick Connect

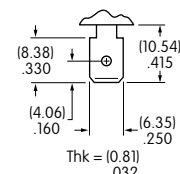

TYPICAL SWITCH DIMENSIONS

.520" (13.2mm) Dia. Cap • .187" (4.75mm) Quick Connect

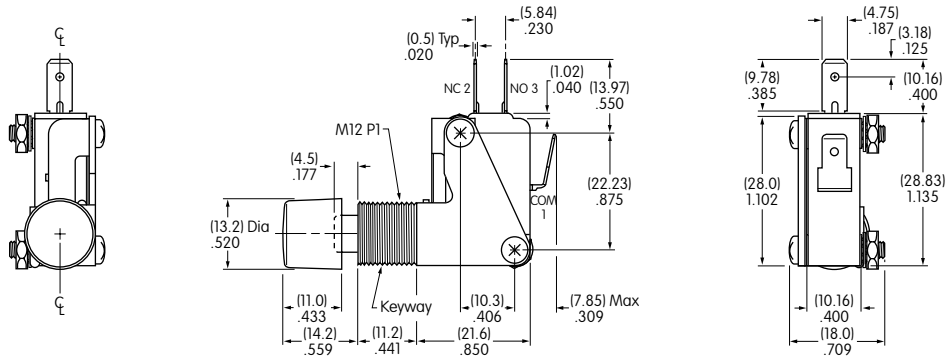

SCB15S15A-3C

Round Cap & Shroud • .187" (4.75mm) Quick Connect

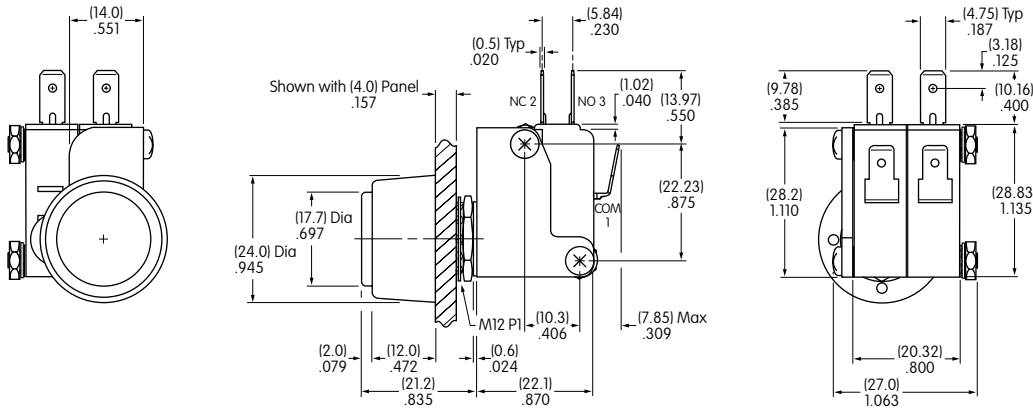

SCB25P15A-4CA

Rectangular Cap & Shroud • .250" (6.35mm) Quick Connect

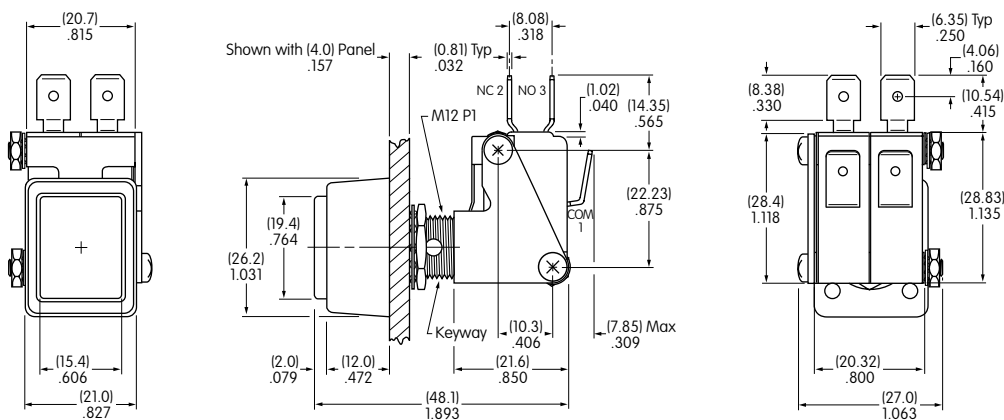

SCB26S15B-5CA

Данный компонент на территории Российской Федерации

Вы можете приобрести в компании MosChip.

Для оперативного оформления запроса Вам необходимо перейти по данной ссылке:

<http://moschip.ru/get-element>

Вы можете разместить у нас заказ для любого Вашего проекта, будь то серийное производство или разработка единичного прибора.

В нашем ассортименте представлены ведущие мировые производители активных и пассивных электронных компонентов.

Нашей специализацией является поставка электронной компонентной базы двойного назначения, продукции таких производителей как XILINX, Intel (ex.ALTERA), Vicor, Microchip, Texas Instruments, Analog Devices, Mini-Circuits, Amphenol, Glenair.

Сотрудничество с глобальными дистрибьюторами электронных компонентов, предоставляет возможность заказывать и получать с международных складов практически любой перечень компонентов в оптимальные для Вас сроки.

На всех этапах разработки и производства наши партнеры могут получить квалифицированную поддержку опытных инженеров.

Система менеджмента качества компании отвечает требованиям в соответствии с ГОСТ Р ИСО 9001, ГОСТ РВ 0015-002 и ЭС РД 009

Офис по работе с юридическими лицами:

105318, г.Москва, ул.Щербаковская д.3, офис 1107, 1118, ДЦ «Щербаковский»

Телефон: +7 495 668-12-70 (многоканальный)

Факс: +7 495 668-12-70 (доб.304)

E-mail: info@moschip.ru

Skype отдела продаж:

moschip.ru

moschip.ru_4

moschip.ru_6

moschip.ru_9