

## GENERAL SPECIFICATIONS

### Electrical Capacity

**Resistive Load:** 15A & ½ HP @ 125 or 250V AC for high capacity models  
**Lamp Load:** 5A @ 125V AC

### Other Ratings

**Contact Resistance:** 15 milliohms maximum  
**Insulation Resistance:** 100 megohms minimum @ 500V DC  
**Dielectric Strength:** 1,000V AC minimum between contacts for 1 minute minimum;  
 1,500V AC minimum between contacts & case for 1 minute minimum  
**Mechanical Life:** 1,000,000 operations minimum  
**Electrical Life:** 50,000 operations minimum  
**Travel:** Pretravel .047" (1.19mm); Overtravel .040" (1.01mm); Differential .011" (0.27mm)  
**Operating Temp Range:** -40°C through +85°C (-40°F through +185°F)

### Materials & Finishes

**Caps & Shrouds:** Polycarbonate with glossy finish or PBT  
**Plunger:** Polyacetal or brass with nickel plating  
**Bushing:** Steel with zinc plating or glass fiber reinforced polyamide  
**Case:** Polyester  
**Movable & Stationary Contacts:** Silver alloy  
**Terminals:** Brass with silver plating

### Standards & Certifications

**UL:** Internal snap switch is UL recognized.  
**CSA:** Internal snap switch is CSA certified.

## TYPICAL SWITCH ORDERING EXAMPLE

SCB

2

5

P

15

A

—

4

CA

**Poles**

1	SPDT
2	DPDT

**Circuits**

5	ON	(ON)
6	ON	ON

( ) = Momentary

**Bushings**

P	Plastic (with momentary only)
S	Steel

**Rating**

15	15A
----	-----

**Terminals**

A	.187" (4.75mm) Quick Connect
* B	.250" (6.35mm) Quick Connect

Note: Contact factory for availability of screw lug and solder lug models.  
 \* Available in Americas only

**Caps & Shrouds**

**For Momentary**

3	.520" (13.2mm) Diameter Cap
---	-----------------------------

**For Momentary & Alternate Action**

4	Round Cap & Shroud (AT454 & AT455)
5	Rectangular Cap & Shroud (AT452 & AT453)

**DESCRIPTION FOR TYPICAL ORDERING EXAMPLE**

SCB25P15A-4CA

DPDT ON-(ON) Circuit

15A Rating

Round Red Cap with Black Shroud

Plastic Bushing

.187" (4.75mm) Quick Connect Terminals

**Colors**

Caps		Shrouds	
A	Black	A	
B	White	B	
C	Red	-	
F	Green	-	
G	Blue	-	
H	Gray	H	

Note: Standard hardware is provided with caps. See Bushing detail for more information.

Toggles

Rockers

Pushbuttons

Illuminated PB

Keylocks

Rotaries

Slides

Tactiles

Tilt





Touch

Indicators

Accessories

Supplement

## POLES & CIRCUITS

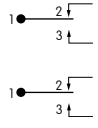
		Plunger Position ( ) = Momentary		Connected Terminals		Throw & Schematics
Pole	Model	Normal  Keyway	Down 	Normal  Keyway	Down 	Note: Terminal numbers are actually on the switch.
SP	SCB15 SCB16	ON ON	(ON) ON	1-2	1-3	SPDT 
DP	SCB25 SCB26	ON ON	(ON) ON	1-2 1-2	1-3 1-3	SP with 2 switches 

## BUSHINGS

**P** Plastic  
(for Momentary only)

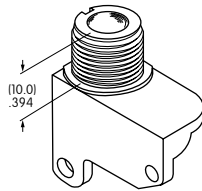

**S** Steel

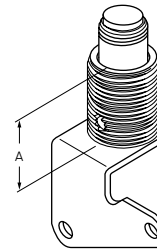

"A" =  
11.2mm  
Momentary  
15.5mm  
Alternate Action

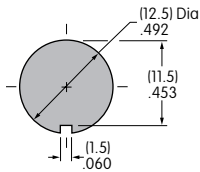

Maximum Effective Panel Thickness:  
.165" (4.2mm) without Shroud  
.157" (4.0mm) with Shroud

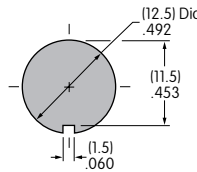

Maximum Effective Panel Thickness:  
Momentary: .177" (4.5mm) without Shroud  
.157" (4.0mm) with Shroud  
Alternate Action: .354" (9.0mm)

### Standard Hardware Provided with Caps

Cap Option 3: AT504M Knurled Face Nut, AT508 Lockwasher, AT527M Hex Mounting Nut

Cap Options 4 & 5: AT508 Lockwasher & AT527M Hex Mounting Nut

## TERMINALS

**A** .187" (4.75mm)  
Quick Connect

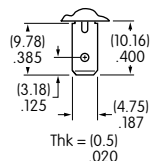

**B** .250" (6.35mm)  
Quick Connect

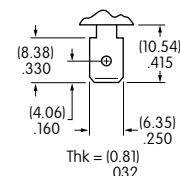

## TYPICAL SWITCH DIMENSIONS

**.520" (13.2mm) Dia. Cap • .187" (4.75mm) Quick Connect**

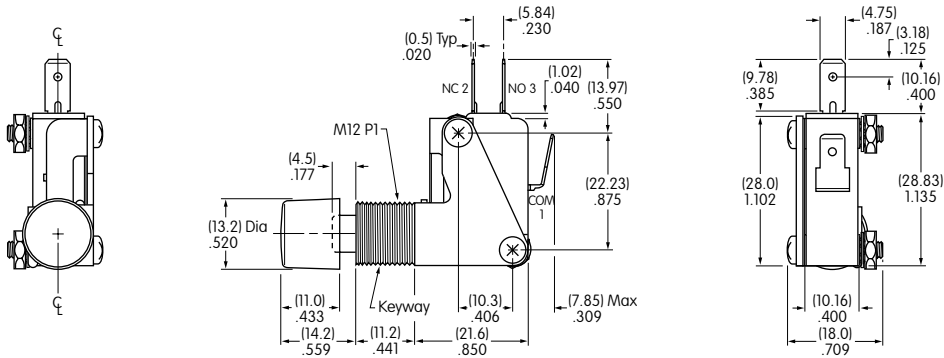

**SCB15S15A-3C**

**Round Cap & Shroud • .187" (4.75mm) Quick Connect**

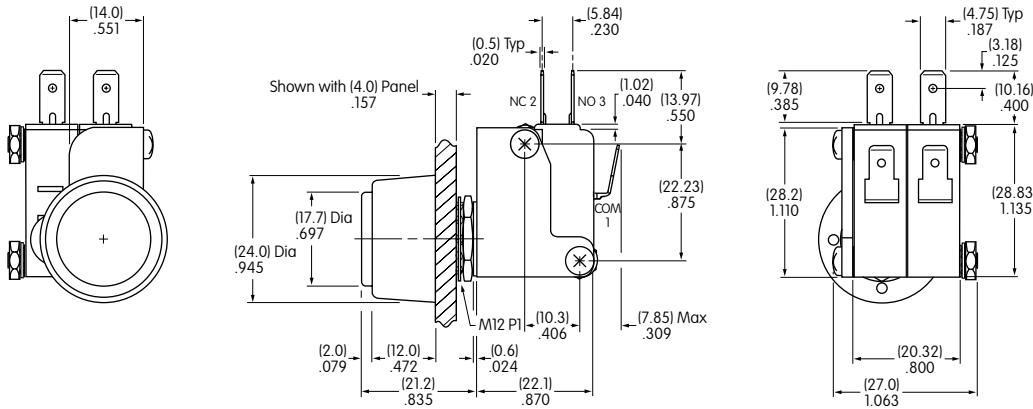

**SCB25P15A-4CA**

**Rectangular Cap & Shroud • .250" (6.35mm) Quick Connect**

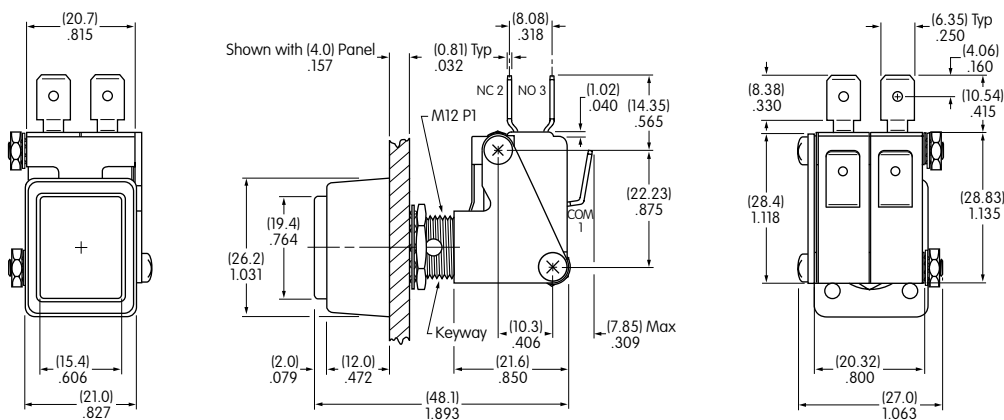

**SCB26S15B-5CA**

## Данный компонент на территории Российской Федерации

### Вы можете приобрести в компании MosChip.

Для оперативного оформления запроса Вам необходимо перейти по данной ссылке:

<http://moschip.ru/get-element>

Вы можете разместить у нас заказ для любого Вашего проекта, будь то серийное производство или разработка единичного прибора.

В нашем ассортименте представлены ведущие мировые производители активных и пассивных электронных компонентов.

Нашей специализацией является поставка электронной компонентной базы двойного назначения, продукции таких производителей как XILINX, Intel (ex.ALTERA), Vicor, Microchip, Texas Instruments, Analog Devices, Mini-Circuits, Amphenol, Glenair.

Сотрудничество с глобальными дистрибьюторами электронных компонентов, предоставляет возможность заказывать и получать с международных складов практически любой перечень компонентов в оптимальные для Вас сроки.

На всех этапах разработки и производства наши партнеры могут получить квалифицированную поддержку опытных инженеров.

Система менеджмента качества компании отвечает требованиям в соответствии с ГОСТ Р ИСО 9001, ГОСТ РВ 0015-002 и ЭС РД 009

### Офис по работе с юридическими лицами:

105318, г.Москва, ул.Щербаковская д.3, офис 1107, 1118, ДЦ «Щербаковский»

Телефон: +7 495 668-12-70 (многоканальный)

Факс: +7 495 668-12-70 (доб.304)

E-mail: [info@moschip.ru](mailto:info@moschip.ru)

Skype отдела продаж:

moschip.ru

moschip.ru\_4

moschip.ru\_6

moschip.ru\_9