

General Specifications

Toggles

Rockers

Pushbuttons

Illuminated PB

Programmable

Keylocks

Rotaries

Slides

Tactiles

Tilt

Touch

Indicators

Accessories

Supplement

Electrical Capacity (Resistive Load)

Power Level (silver): 5A @ 125/250V AC or 5A @ 30V DC
Logic Level (gold): 0.4VA maximum @ 28V AC/DC maximum
 (Applicable Range 0.1mA ~ 0.1A @ 20mV ~ 28V)
 Note: Find additional explanation of operating range in Supplement section.

Other Ratings

Contact Resistance: 50 milliohms maximum for silver; 100 milliohms maximum for gold
Insulation Resistance: 200 megohms minimum @ 500V DC
Dielectric Strength: 1,000V AC minimum between contacts for 1 minute minimum;
 1,500V AC minimum between contacts & case for 1 minute minimum

Mechanical Life: 1,000,000 operations minimum for momentary;
 200,000 operations minimum for alternate action

Electrical Life: 10,000 operations minimum for silver;
 200,000 operations minimum for gold

Nominal Operating Force: Single Pole: 1.90N
 Double Pole: 2.55N

Contact Timing: Break before make
Travel: Pretravel .067" (1.7mm); Overtravel .024" (0.6mm); Total Travel .091" (2.3mm)

Materials & Finishes

Housing/Bezel: Glass fiber reinforced polyamide (UL94V-0)
Snap-in Frame: Stainless steel
Movable Contact: Phosphor bronze
Movable Contacts: Silver alloy or copper with gold plating
Stationary Contacts: Silver alloy or copper with gold plating
Switch Terminals: Phosphor bronze with silver or gold plating
Lamp Terminals: Brass with tin plating
Base: Glass fiber reinforced liquid crystal polymer (UL94V-0)

Environmental Data

Operating Temperature Range: -25°C through +50°C (-13°F through +122°F) for Illuminated
 -25°C through +70°C (-13°F through +158°F) for Nonilluminated
Humidity: 90 ~ 95% humidity for 240 hours @ 40°C (104°F)
Vibration: 10 ~ 55Hz with peak-to-peak amplitude of 1.5mm traversing the frequency range & returning in 1 minute; 3 right angled directions for 2 hours
Shock: 50G (490m/s²) acceleration (tested in 6 right angled directions, with 5 shocks in each direction)

Installation

Cap Installation Force: 15.0N maximum downward force on cap

Processing

Soldering: Wave Soldering (PC version): See Profile A in Supplement section.
 Manual Soldering: See Profile A in Supplement section.
Cleaning: These devices are not process sealed. Hand clean locally using alcohol based solution.

Standards & Certifications

Flammability Standards: UL94V-0 housing/bezel & base
UL: File No. E44145 - Recognized only when ordered with marking on switch.
 Add "/U" or "/CUL" before dash in part number to order UL recognized switch.
 UL recognized only when ordered switch body with cap assembled.
 All single & double pole models recognized at 5A @ 125/250V AC or 0.014A @ 28V DC.

Distinctive Characteristics

Wide selection of illumination effects is achieved with single and bicolor, 1- or 6-element LEDs in flat, beveled, or sculptured caps.

Alternating legends (patent pending) in choice of sculptured or flat caps, combined with super bright bicolor LED.

Combination of PCB mountability and short body allows use in compact applications.

Small behind panel dimension for snap-in mounting in tight spaces.

Snap-acting contact mechanism provides sensitive actuation with audible feedback; quick-make, quick-break characteristic limits arcing and prolongs electrical life.

Latchdown mechanism, independent of switching mechanism, gives outstanding stability and reliability plus visible and tactile indication of circuit status.

Terminals are epoxy sealed to lock out flux, solvents, and other contaminants.

Momentary and alternate action circuits available in the same space-saving body size.

Matching indicators available.



Actual Size



- Toggles
- Rockers
- Pushbuttons
- D Illuminated PB**
- Programmable
- Keylocks
- Rotaries
- Slides
- Tactiles
- Tilt
- Touch
- Indicators
- Accessories
- Supplement

TYPICAL SWITCH

ORDERING EXAMPLE



IMPORTANT:





Switches are supplied without UL & cULus marking unless specified. **UL & cULus recognized only when ordered with marking on switch.** Specific models, ratings, & ordering instructions are noted on the General Specifications page.

DESCRIPTION FOR TYPICAL ORDERING EXAMPLE

UB215SKG035C-1JC



POLES & CIRCUITS

Pole	Model	Plunger Position () = Momentary		Connected Terminals		Throw & Switch/Lamp Schematics
		Normal	Down	Normal	Down	
SP	UB215 *UB216	ON ON	(ON) ON	1-3	1-2	Notes: Switch is marked with NC, NO, COM, L+ & L-. Lamp circuit is isolated and requires an external power source. SPDT  
DP	UB225 *UB226	ON ON	(ON) ON	1-3 4-6	1-2 4-5	DPDT  

* When in latchdown position for the alternate circuit, cap positions above the housing are:
.059" (1.5mm) for snap-in models & .276" (7.0mm) for PCB models.

MOUNTING TYPES & SHAPES

PCB Mounting



Square

SP, Single Color LED

DP, Single Color LED

SP, Bicolor LED

DP, Bicolor LED

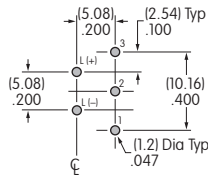
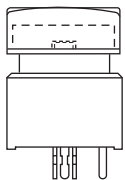

Snap-in Mounting (Solder Lug)



Square with Built-in Bezel

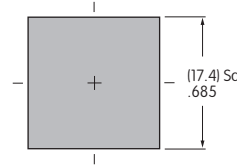
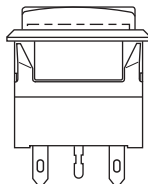

Panel Thickness:
.039 ~ .126"
(1.0 ~ 3.2mm)

CONTACT MATERIALS & RATINGS



Silver Contacts

Power Level

5A @ 125V AC & 250V AC



Gold Contacts

Logic Level

0.4VA maximum @ 28V AC/DC maximum

Complete explanation of operating range in Supplement section.

SWITCH & LAMP TERMINALS



Solder Lug

For Switch & Bright LED

For Super Bright & Bicolor LED



Straight PC

For Switch & Bright LED

For Super Bright & Bicolor LED

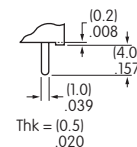
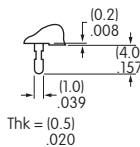
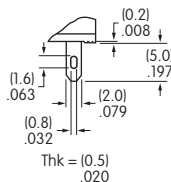

BRIGHT LED & CAPS

The electrical specifications shown are determined at a basic temperature of 25°C.
 LED circuit is isolated and requires an external power source. Polarity marks are on the bottom of the switch.
 If the source voltage exceeds the rated voltage, a ballast resistor is required.
 The resistor value can be calculated by using the formula in the Supplement section.

The LED is an integral part of the switch and not available separately.

Electrical Specifications for Bright LED

		5C	5D	5F	
	Color	Red	Amber	Green	Unit
Maximum Forward Current	I_{FM}	30	30	25	mA
Typical Forward Current	I_F	20	20	20	mA
Forward Voltage	V_F	1.85	2.0	2.1	V
Maximum Reverse Voltage	V_{RM}	5	5	5	V
Current Reduction Rate Above 25°C	ΔI_F	0.40	0.42	0.46	mA/°C
Ambient Temperature Range		-25° ~ +50°			°C

Bright Single Color LED with 1 element



Caps for Bright LED

1 AT3074 Sculptured

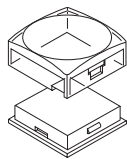

Clear Lens
 Translucent Colored Diffuser

2 AT3075 Beveled

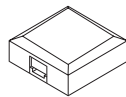

Translucent Colored Cap

3 AT3076 Flat

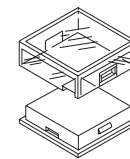
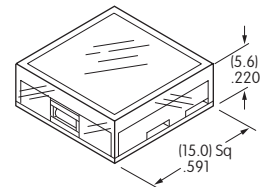

Clear Lens
 Translucent Colored Diffuser

Lens/Diffuser Colors Available:

- JB** Clear/White
- JC** Clear/Red
- JD** Clear/Amber
- JF** Clear/Green

Cap Colors Available:

- B** White
- C** Red
- D** Amber
- F** Green

Lens/Diffuser Colors Available:

- JB** Clear/White
- JC** Clear/Red
- JD** Clear/Amber
- JF** Clear/Green

Material: Polycarbonate

Finish: Glossy

SUPER BRIGHT LEDs & CAPS

The electrical specifications shown are determined at a basic temperature of 25°C.
LED circuit is isolated and requires an external power source. Polarity marks are on the bottom of the switch.

If the source voltage exceeds the rated voltage, a ballast resistor is required.
The resistor value can be calculated by using the formula in the Supplement section.

The LED is an integral part of the switch and not available separately.

Electrical Specifications for Super Bright LEDs

Super Bright LEDs are Electrostatic Sensitive	ATTENTION ELECTROSTATIC SENSITIVE DEVICES	Color	6B	6F	6G	Unit
			White	Green	Blue	
Maximum Forward Current		I_{FM}	20	30	30	mA
Typical Forward Current		I_F	15	20	20	mA
Forward Voltage		V_F	3.3	3.5	3.6	V
Maximum Reverse Voltage		V_{RM}	5	5	5	V
Current Reduction Rate Above 25°C		ΔI_F	0.25	0.50	0.50	mA/°C
Ambient Temperature Range			-20° ~ +50°			°C

Super Bright Single Color LED with 1 element

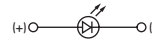

Caps for Super Bright LED

1JB AT3074JB Sculptured Clear Lens/White Diffuser



2B AT3075B Beveled White Cap

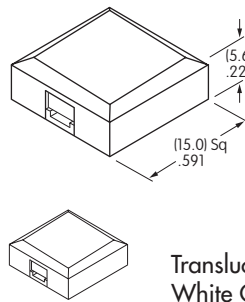

3JB AT3076JB Flat Clear Lens/White Diffuser



Material: Polycarbonate Finish: Glossy

SUPER BRIGHT BICOLOR LED & CAPS

Electrical Specifications for Super Bright Bicolor LED

The electrical specifications shown are determined at a basic temperature of 25°C. LED circuit is isolated and requires an external power source. Polarity marks are on bottom of switch. If the source voltage exceeds the rated voltage, a ballast resistor is required. The resistor value can be calculated by using the formula in Supplement Section. The LED is an integral part of the switch and not available separately.	Super Bright LEDs are Electrostatic Sensitive	ATTENTION ELECTROSTATIC SENSITIVE DEVICES	Color	6CF	Unit			
				Red/Green				
				Maximum Forward Current		I_{FM}	30/25 (25/22 for Amber)	mA
				Typical Forward Current		I_F	20/20	mA
				Forward Voltage		V_F	2.1/3.5	V
				Maximum Reverse Voltage		V_{RM}	4/4	V
				Current Reduction Rate Above 25°C		ΔI_F	0.40/0.33	mA/°C
Ambient Temperature Range		-25° ~ +50°	°C					

Super Bright Bicolor LED with 2 elements

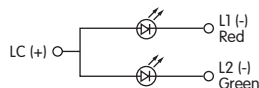

Amber color is achieved by lighting red and green simultaneously, but is not suitable for Alternating Legends.

Caps for Super Bright Bicolor LED

1JB AT3074JB Sculptured Clear Lens/White Diffuser



2B AT3075B Beveled White Cap



3JB AT3076JB Flat Clear Lens/White Diffuser



Material: Polycarbonate Finish: Glossy

Alternating Legend Caps for Super Bright Bicolor LED

4J AT3069J Sculptured Cap with Alternating Legend



5J AT3070J Flat Cap with Alternating Legend



Material: Polycarbonate Finish: Glossy

Standard Alternating Legend Pairs



Cap illumination is alternating green/red; legend text is black.
Contact factory for other Alternating Legends.

Legend illustrations are approximate representations of the actual characters on the filters.

No Code No Lamp

CAP TYPES & COLOR COMBINATIONS FOR NONILLUMINATED

4 AT3073 Sculptured

Lens/Insert Colors Available:

- JA** Clear/Black
- JB** Clear/White
- JC** Clear/Red
- JD** Clear/Amber
- JF** Clear/Green

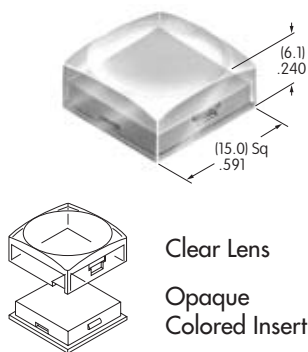

Material: Polycarbonate
Finish: Glossy

5 AT3077 Beveled

Cap Colors Available:

- A** Black
- B** White
- C** Red
- D** Amber
- F** Green

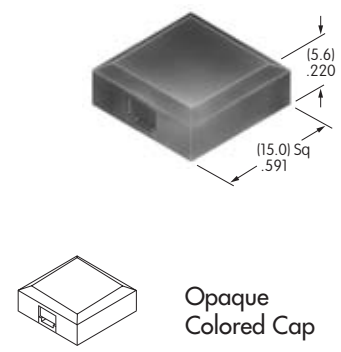

Material: Polycarbonate
Finish: Glossy

TYPICAL SWITCH DIMENSIONS

Bright & Super Bright LED Straight PC



UB215SKG035C-1JC

Bright Single Color LED

Super Bright Single Color LED

Single Pole

Double Pole

Bicolor LED Straight PC

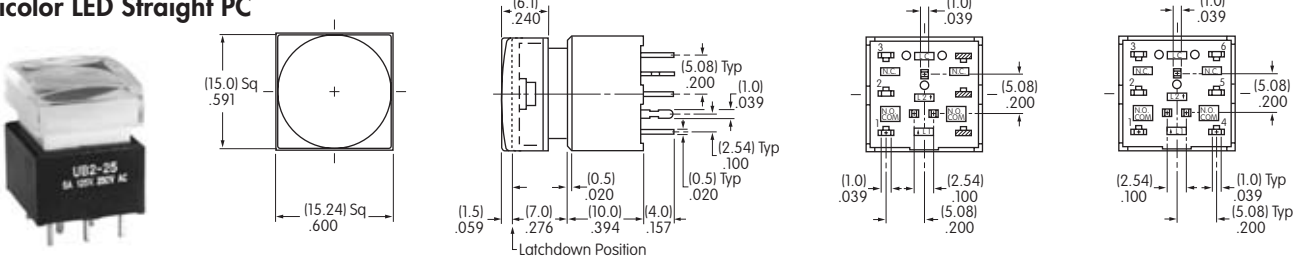

UB225SKG03CF-1JB

Bicolor LED Side View

Single Pole

Double Pole

Bright LED Solder Lug



UB216KKW015F-1JF

Single Color LED Side View

Single Pole

Double Pole

Super Bright LED Solder Lug

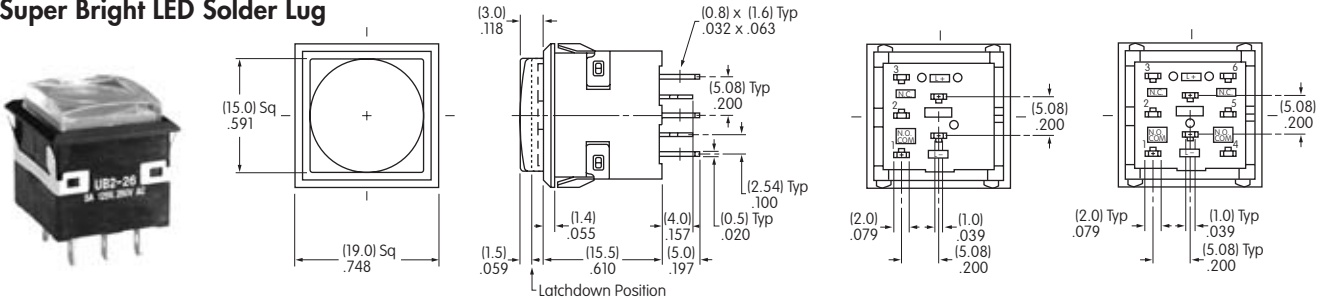

UB226KKW016F-1JF

Single Color LED Side View

Single Pole

Double Pole

Bicolor LED Solder Lug

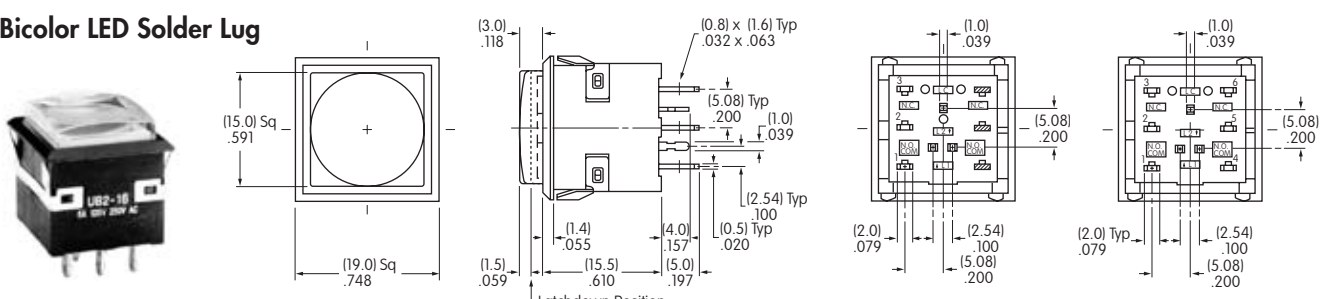

UB216KKW01CF-1JB

Bicolor LED Side View

Single Pole

Double Pole

Toggles

Rockers

Pushbuttons

Illuminated PB

Programmable

Keylocks

Rotaries

Slides

Tactiles

Tilt

Touch

Indicators

Accessories

Supplement

OPTIONAL ACCESSORIES

Protective Guard for Snap-in Model

AT4141

Opens 90°
Closes manually



Materials:

Cover: Clear Polycarbonate
Base: Black GFR Polyamide

Recommended Panel Thickness:

.039" ~ .106" (1.0mm ~ 2.7mm)

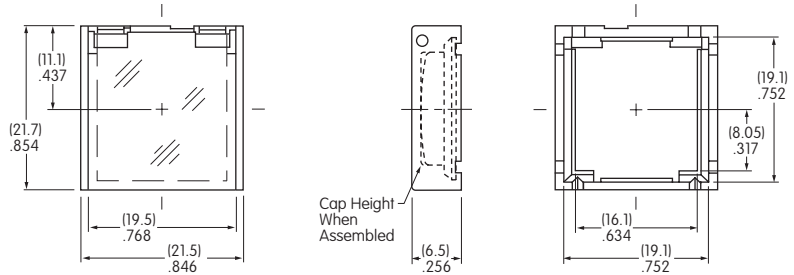

Spring Loaded Protective Guard for Snap-in Mounting of PCB Model

AT4170

Opens 180°
Closes automatically



Materials:

Cover: Clear Polycarbonate
Base: Black Polyamide
Coil Spring: Stainless Steel

Recommended Panel Thickness:

.039" ~ .126"
(1.0mm ~ 3.2mm)

Recommended Panel-to-PCB Range:

.531" ~ .622"
(13.5mm ~ 15.8mm)

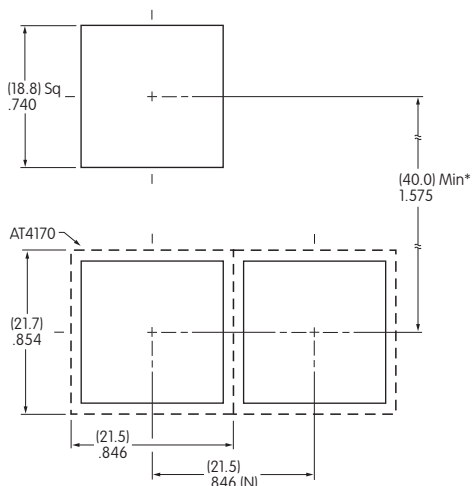
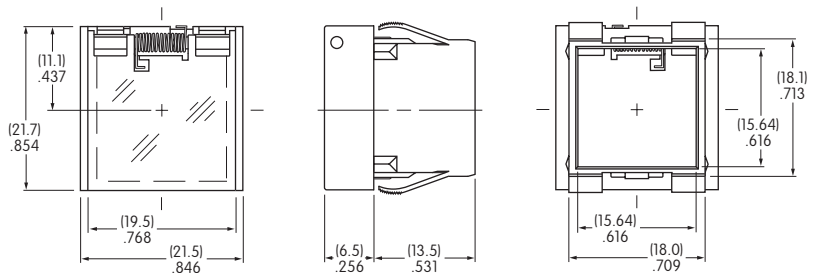

(N) = Number of switches

* Minimum dimension allows opening of cover to 180°

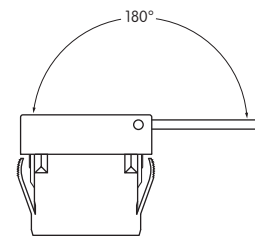
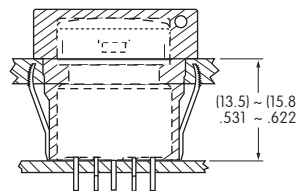

Installation

- 1 Install switch onto PC board.
- 2 Snap protective guard into panel.
- 3 Join the two assemblies.

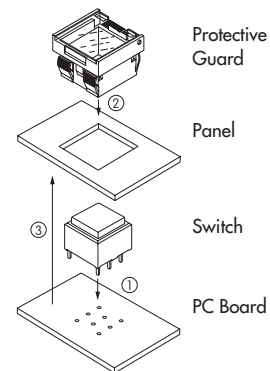

OPTIONAL ACCESSORIES

Spring Loaded Protective Guard for Snap-in Model

AT4142

Opens 180°
Closes automatically



Materials:

Cover: Clear Polycarbonate
Base: Black GFR Polyamide
Coil Spring: Stainless Steel

Recommended Panel Thickness:

.039" ~ .106" (1.0mm ~ 2.7mm)



Dust Cover

AT4145 Not for use with barriers.

Materials:

Lid: Clear PVC
Operating temperature range:
0°C ~ +70°C (32°F ~ 158°C).
Gasket: Polyethylene



Recommended Panel Thickness

.039" ~ .098" (1.0mm ~ 2.5mm)



Barriers for Snap-in Mount

AT4143 End

AT4144 Center



Cutouts for more than 1 Switch:

$$A = .799" (20.3\text{mm}) \times \text{Number of Switches} + .051" (1.3\text{mm})$$

Material: Polyamide

LEGENDS

NKK Switches can provide custom legends for caps. Contact factory for more information.

Suggested Printable Area for UB2 Lens, Film Insert or Diffuser

Recommended Methods: Laser Etch on clear lens, Screen Print or Pad Print on lens;
Laser Print on film insert.

Shaded areas are printable areas.

Beveled Cap



Flat Cap

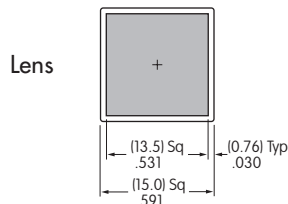

Film Insert or Diffuser

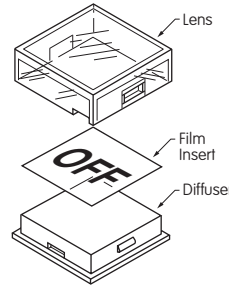

Sculptured Cap

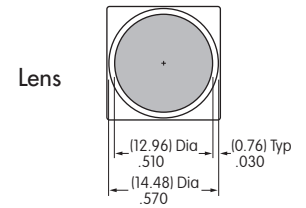

Film Insert or Diffuser

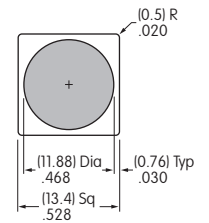

Film Insert: Clear Polyester 4 mil maximum thickness

Toggles

Rockers

Pushbuttons

Illuminated PB

Programmable

Keylocks

Rotaries

Slides

Tactiles

Tilt

Touch

Indicators

Accessories

Supplement

Данный компонент на территории Российской Федерации

Вы можете приобрести в компании MosChip.

Для оперативного оформления запроса Вам необходимо перейти по данной ссылке:

<http://moschip.ru/get-element>

Вы можете разместить у нас заказ для любого Вашего проекта, будь то серийное производство или разработка единичного прибора.

В нашем ассортименте представлены ведущие мировые производители активных и пассивных электронных компонентов.

Нашей специализацией является поставка электронной компонентной базы двойного назначения, продукции таких производителей как XILINX, Intel (ex.ALTERA), Vicor, Microchip, Texas Instruments, Analog Devices, Mini-Circuits, Amphenol, Glenair.

Сотрудничество с глобальными дистрибьюторами электронных компонентов, предоставляет возможность заказывать и получать с международных складов практически любой перечень компонентов в оптимальные для Вас сроки.

На всех этапах разработки и производства наши партнеры могут получить квалифицированную поддержку опытных инженеров.

Система менеджмента качества компании отвечает требованиям в соответствии с ГОСТ Р ИСО 9001, ГОСТ РВ 0015-002 и ЭС РД 009

Офис по работе с юридическими лицами:

105318, г.Москва, ул.Щербаковская д.3, офис 1107, 1118, ДЦ «Щербаковский»

Телефон: +7 495 668-12-70 (многоканальный)

Факс: +7 495 668-12-70 (доб.304)

E-mail: info@moschip.ru

Skype отдела продаж:

moschip.ru

moschip.ru_4

moschip.ru_6

moschip.ru_9