

# General Specifications

## Electrical Capacity (Resistive Load)

**Power Level (silver):** 5A @ 125/250V AC or 5A @ 30V DC  
**Logic Level (gold):** 0.4VA maximum @ 28V AC/DC maximum  
 (Applicable Range 0.1mA ~ 0.1A @ 20mV ~ 28V)  
 Note: Find additional explanation of operating range in Supplement section.

## Other Ratings

**Contact Resistance:** 50 milliohms maximum for silver; 100 milliohms maximum for gold  
**Insulation Resistance:** 200 megohms minimum @ 500V DC  
**Dielectric Strength:** 1,000V AC minimum between contacts for 1 minute minimum;  
 1,500V AC minimum between contacts & case for 1 minute minimum

**Mechanical Life:** 1,000,000 operations minimum for momentary;  
 200,000 operations minimum for alternate action

**Electrical Life:** 10,000 operations minimum for silver;  
 200,000 operations minimum for gold

**Nominal Operating Force:** Single Pole: 1.90N  
 Double Pole: 2.55N

**Contact Timing:** Break before make  
**Travel:** Pretravel .067" (1.7mm); Overtravel .024" (0.6mm); Total Travel .091" (2.3mm)

## Materials & Finishes

**Housing/Bezel:** Glass fiber reinforced polyamide (UL94V-0)  
**Snap-in Frame:** Stainless steel  
**Movable Contactor:** Phosphor bronze  
**Movable Contacts:** Silver alloy or copper with gold plating  
**Stationary Contacts:** Silver alloy or copper with gold plating  
**Switch Terminals:** Phosphor bronze with silver or gold plating  
**Lamp Terminals:** Brass with tin plating  
**Base:** Glass fiber reinforced liquid crystal polymer (UL94V-0)

## Environmental Data

**Operating Temperature Range:** -25°C through +50°C (-13°F through +122°F) for Illuminated  
 -25°C through +70°C (-13°F through +158°F) for Nonilluminated  
**Humidity:** 90 ~ 95% humidity for 240 hours @ 40°C (104°F)  
**Vibration:** 10 ~ 55Hz with peak-to-peak amplitude of 1.5mm traversing the frequency range & returning in 1 minute; 3 right angled directions for 2 hours  
**Shock:** 50G (490m/s<sup>2</sup>) acceleration (tested in 6 right angled directions, with 5 shocks in each direction)

## Installation

**Cap Installation Force:** 15.0N maximum downward force on cap

## Processing

**Soldering:** Wave Soldering (PC version): See Profile A in Supplement section.  
 Manual Soldering: See Profile A in Supplement section.  
**Cleaning:** These devices are not process sealed. Hand clean locally using alcohol based solution.

## Standards & Certifications

**Flammability Standards:** UL94V-0 housing/bezel & base  
**UL:** **File No. E44145 - Recognized only when ordered with marking on switch.**  
 Add "/U" or "/CUL" before dash in part number to order UL recognized switch.  
 UL recognized only when ordered switch body with cap assembled.  
 All single & double pole models recognized at 5A @ 125/250V AC or 0.014A @ 28V DC.

# Distinctive Characteristics

Wide selection of illumination effects is achieved with single and bicolor, 1- or 6-element LEDs in flat, beveled, or sculptured caps.

Alternating legends (patent pending) in choice of sculptured or flat caps, combined with super bright bicolor LED.

Combination of PCB mountability and short body allows use in compact applications.

Small behind panel dimension for snap-in mounting in tight spaces.

Snap-acting contact mechanism provides sensitive actuation with audible feedback; quick-make, quick-break characteristic limits arcing and prolongs electrical life.

Latchdown mechanism, independent of switching mechanism, gives outstanding stability and reliability plus visible and tactile indication of circuit status.

Terminals are epoxy sealed to lock out flux, solvents, and other contaminants.

Momentary and alternate action circuits available in the same space-saving body size.

Matching indicators available.



Actual Size

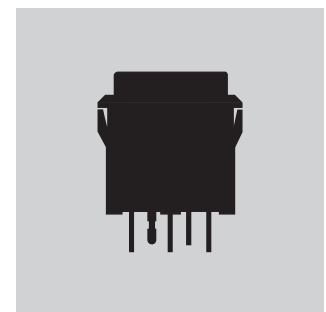

- Toggles
- Rockers
- Pushbuttons
- D Illuminated PB**
- Programmable
- Keylocks
- Rotaries
- Slides
- Tactiles
- Tilt
- Touch
- Indicators
- Accessories
- Supplement

### TYPICAL SWITCH

### ORDERING EXAMPLE



### IMPORTANT:





Switches are supplied without UL & cULus marking unless specified. **UL & cULus recognized only when ordered with marking on switch.** Specific models, ratings, & ordering instructions are noted on the General Specifications page.

### DESCRIPTION FOR TYPICAL ORDERING EXAMPLE

**UB215SKG035C-1JC**



## POLES & CIRCUITS

Pole	Model	Plunger Position ( ) = Momentary		Connected Terminals		Throw & Switch/Lamp Schematics
		Normal	Down	Normal	Down	
SP	UB215 *UB216	ON ON	(ON) ON	1-3	1-2	Notes: Switch is marked with NC, NO, COM, L+ & L-. Lamp circuit is isolated and requires an external power source. SPDT  
DP	UB225 *UB226	ON ON	(ON) ON	1-3 4-6	1-2 4-5	DPDT  

\* When in latchdown position for the alternate circuit, cap positions above the housing are: .059" (1.5mm) for snap-in models & .276" (7.0mm) for PCB models.

## MOUNTING TYPES & SHAPES

### PCB Mounting



**Square**

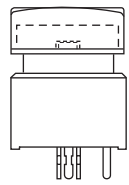

SP, Single Color LED

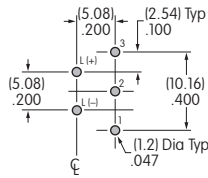

DP, Single Color LED

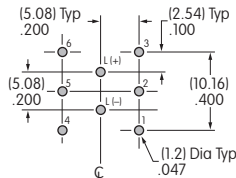

SP, Bicolor LED

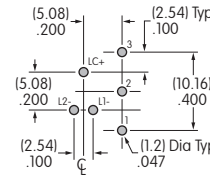

DP, Bicolor LED

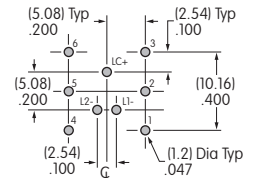

### Snap-in Mounting (Solder Lug)



**Square with Built-in Bezel**

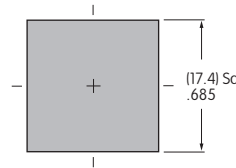
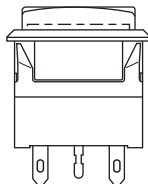

Panel Thickness:  
.039 ~ .126"  
(1.0 ~ 3.2mm)

## CONTACT MATERIALS & RATINGS



**Silver Contacts**

**Power Level**

**5A @ 125V AC & 250V AC**



**Gold Contacts**

**Logic Level**

**0.4VA maximum @ 28V AC/DC maximum**

Complete explanation of operating range in Supplement section.

## SWITCH & LAMP TERMINALS



**Solder Lug**

For Switch & Bright LED

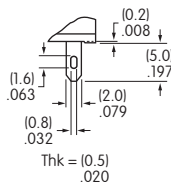

For Super Bright & Bicolor LED

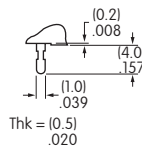

**Straight PC**

For Switch & Bright LED

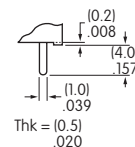

For Super Bright & Bicolor LED

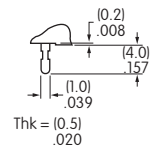

## BRIGHT LED & CAPS

The electrical specifications shown are determined at a basic temperature of 25°C.  
 LED circuit is isolated and requires an external power source. Polarity marks are on the bottom of the switch.  
 If the source voltage exceeds the rated voltage, a ballast resistor is required.  
 The resistor value can be calculated by using the formula in the Supplement section.

The LED is an integral part of the switch and not available separately.

### Electrical Specifications for Bright LED

		<b>5C</b>	<b>5D</b>	<b>5F</b>	
	Color	Red	Amber	Green	Unit
Maximum Forward Current	$I_{FM}$	30	30	25	mA
Typical Forward Current	$I_F$	20	20	20	mA
Forward Voltage	$V_F$	1.85	2.0	2.1	V
Maximum Reverse Voltage	$V_{RM}$	5	5	5	V
Current Reduction Rate Above 25°C	$\Delta I_F$	0.40	0.42	0.46	mA/°C
Ambient Temperature Range		-25° ~ +50°			°C

Bright Single Color LED with 1 element



### Caps for Bright LED

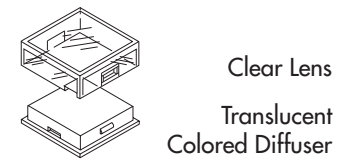
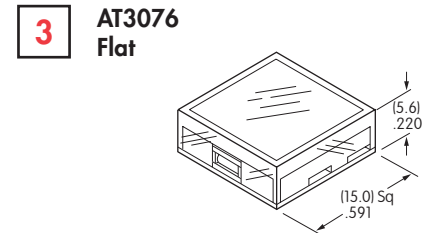
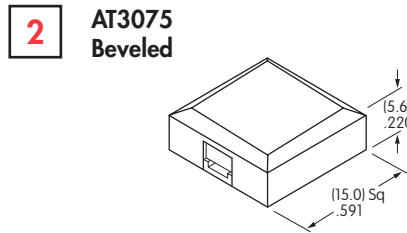
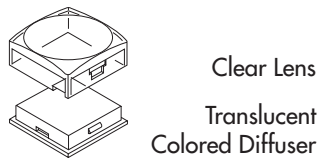
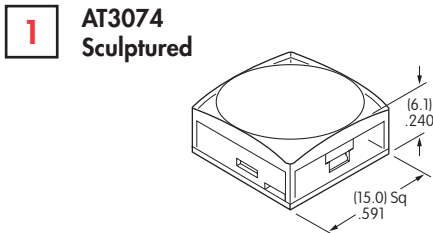

#### Lens/Diffuser Colors Available:

- JB** Clear/White
- JC** Clear/Red
- JD** Clear/Amber
- JF** Clear/Green

#### Cap Colors Available:

- B** White
- C** Red
- D** Amber
- F** Green

#### Lens/Diffuser Colors Available:

- JB** Clear/White
- JC** Clear/Red
- JD** Clear/Amber
- JF** Clear/Green

Material: Polycarbonate

Finish: Glossy

## SUPER BRIGHT LEDs & CAPS

The electrical specifications shown are determined at a basic temperature of 25°C.  
LED circuit is isolated and requires an external power source. Polarity marks are on the bottom of the switch.

If the source voltage exceeds the rated voltage, a ballast resistor is required.  
The resistor value can be calculated by using the formula in the Supplement section.

The LED is an integral part of the switch and not available separately.

### Electrical Specifications for Super Bright LEDs

Super Bright LEDs are Electrostatic Sensitive	ATTENTION ELECTROSTATIC SENSITIVE DEVICES	Color	6B	6F	6G	Unit
			White	Green	Blue	
Maximum Forward Current		$I_{FM}$	20	30	30	mA
Typical Forward Current		$I_F$	15	20	20	mA
Forward Voltage		$V_F$	3.3	3.5	3.6	V
Maximum Reverse Voltage		$V_{RM}$	5	5	5	V
Current Reduction Rate Above 25°C		$\Delta I_F$	0.25	0.50	0.50	mA/°C
Ambient Temperature Range			-20° ~ +50°			°C

Super Bright Single Color LED with 1 element

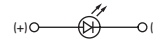

### Caps for Super Bright LED

**1JB** AT3074JB Sculptured Clear Lens/White Diffuser



**2B** AT3075B Beveled White Cap

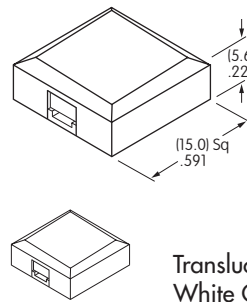

**3JB** AT3076JB Flat Clear Lens/White Diffuser

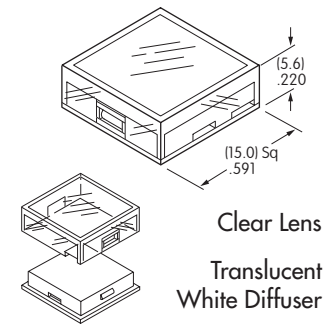

Material: Polycarbonate Finish: Glossy

## SUPER BRIGHT BICOLOR LED & CAPS

### Electrical Specifications for Super Bright Bicolor LED

The electrical specifications shown are determined at a basic temperature of 25°C. LED circuit is isolated and requires an external power source. Polarity marks are on bottom of switch. If the source voltage exceeds the rated voltage, a ballast resistor is required. The resistor value can be calculated by using the formula in Supplement Section. The LED is an integral part of the switch and not available separately.	Super Bright LEDs are Electrostatic Sensitive	ATTENTION ELECTROSTATIC SENSITIVE DEVICES	Color	6CF	Unit			
				Red/Green				
				Maximum Forward Current		$I_{FM}$	30/25 (25/22 for Amber)	mA
				Typical Forward Current		$I_F$	20/20	mA
				Forward Voltage		$V_F$	2.1/3.5	V
				Maximum Reverse Voltage		$V_{RM}$	4/4	V
				Current Reduction Rate Above 25°C		$\Delta I_F$	0.40/0.33	mA/°C
Ambient Temperature Range		-25° ~ +50°	°C					

Super Bright Bicolor LED with 2 elements

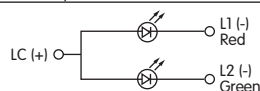

Amber color is achieved by lighting red and green simultaneously, but is not suitable for Alternating Legends.

Caps for Super Bright Bicolor LED

1JB

AT3074JB Sculptured Clear Lens/White Diffuser



2B

AT3075B Beveled White Cap

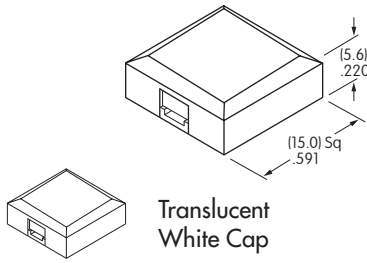

3JB

AT3076JB Flat Clear Lens/White Diffuser

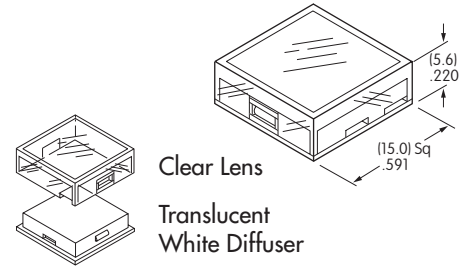

Material: Polycarbonate Finish: Glossy

Alternating Legend Caps for Super Bright Bicolor LED

4J

AT3069J Sculptured Cap with Alternating Legend

Clear Lens Alternating Legend Filter



5J

AT3070J Flat Cap with Alternating Legend

Clear Lens Alternating Legend Filter



Material: Polycarbonate Finish: Glossy

Standard Alternating Legend Pairs

01

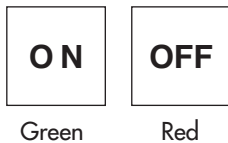

02

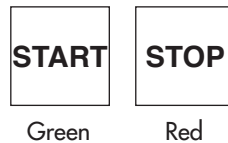

04

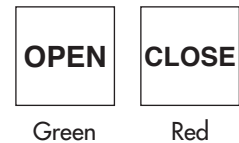

Cap illumination is alternating green/red; legend text is black.  
Contact factory for other Alternating Legends.

Legend illustrations are approximate representations of the actual characters on the filters.

No Code

No Lamp

CAP TYPES & COLOR COMBINATIONS FOR NONILLUMINATED

4

AT3073 Sculptured

Lens/Insert Colors Available:

JA

Clear/Black

JB

Clear/White

JC

Clear/Red

JD

Clear/Amber

JF

Clear/Green

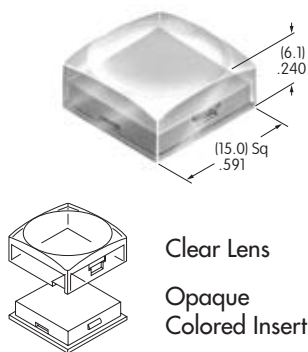

Material: Polycarbonate Finish: Glossy

5

AT3077 Beveled

Cap Colors Available:

A

Black

B

White

C

Red

D

Amber

F

Green

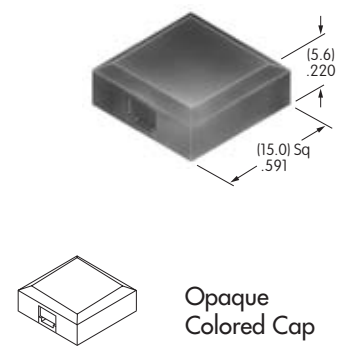

Material: Polycarbonate Finish: Glossy

Toggles  
Rockers  
Pushbuttons  
Illuminated PB  
Programmable  
Keylocks  
Rotaries  
Slides  
Tactiles  
Tilt  
Touch  
Indicators  
Accessories  
Supplement

## TYPICAL SWITCH DIMENSIONS

### Bright & Super Bright LED Straight PC



**UB215SKG035C-1JC**

Bright Single Color LED

Super Bright Single Color LED

Single Pole

Double Pole

### Bicolor LED Straight PC

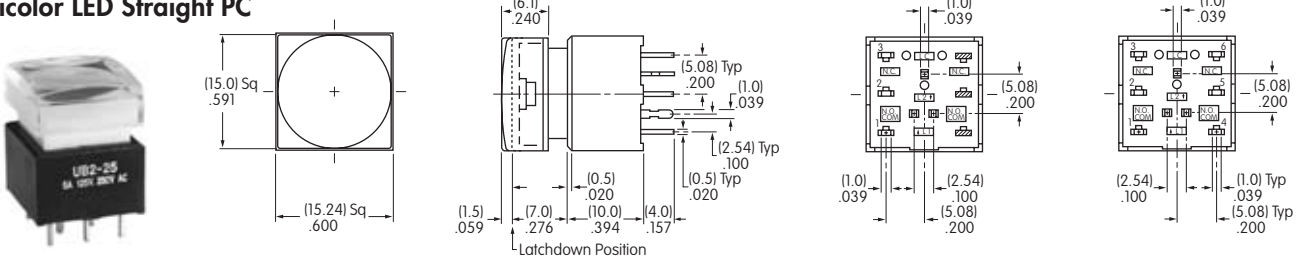

**UB225SKG03CF-1JB**

Bicolor LED Side View

Single Pole

Double Pole

### Bright LED Solder Lug



**UB216KKW015F-1JF**

Single Color LED Side View

Single Pole

Double Pole

### Super Bright LED Solder Lug

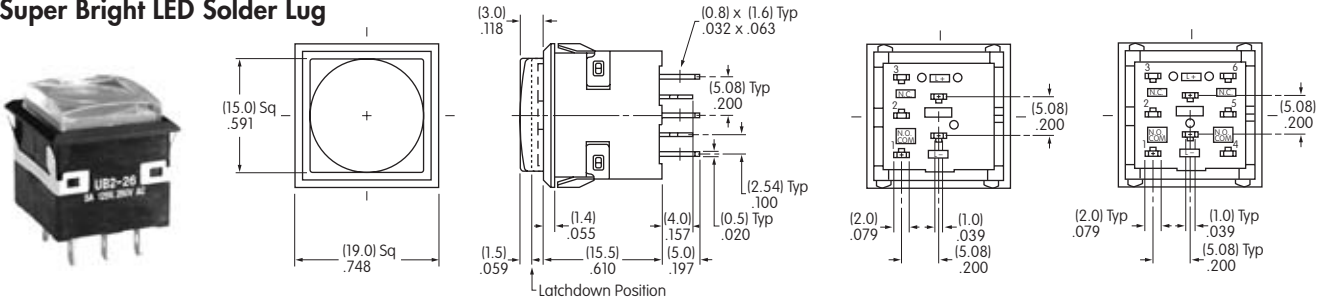

**UB226KKW016F-1JF**

Single Color LED Side View

Single Pole

Double Pole

### Bicolor LED Solder Lug

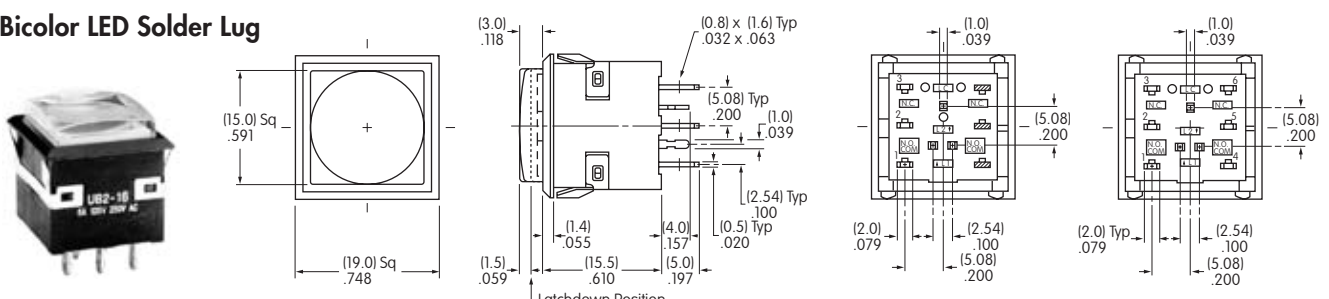

**UB216KKW01CF-1JB**

Bicolor LED Side View

Single Pole

Double Pole

Toggles

Rockers

Pushbuttons

Illuminated PB

Programmable

Keylocks

Rotaries

Slides

Tactiles

Tilt

Touch

Indicators

Accessories

Supplement



## OPTIONAL ACCESSORIES

### Protective Guard for Snap-in Model

#### AT4141

Opens 90°  
Closes manually



#### Materials:

Cover: Clear Polycarbonate  
Base: Black GFR Polyamide

**Recommended Panel Thickness:**  
.039" ~ .106" (1.0mm ~ 2.7mm)

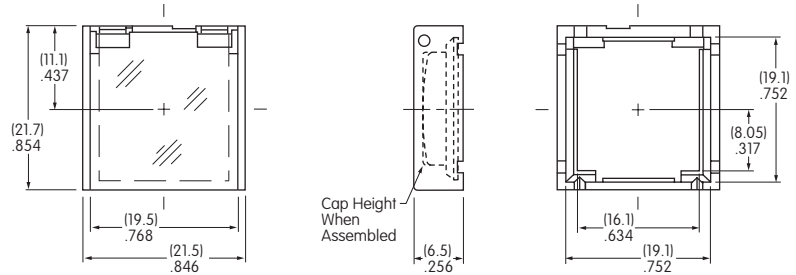

### Spring Loaded Protective Guard for Snap-in Mounting of PCB Model

#### AT4170

Opens 180°  
Closes automatically



#### Materials:

Cover: Clear Polycarbonate  
Base: Black Polyamide  
Coil Spring: Stainless Steel

**Recommended Panel Thickness:**  
.039" ~ .126"  
(1.0mm ~ 3.2mm)

**Recommended Panel-to-PCB Range:**  
.531" ~ .622"  
(13.5mm ~ 15.8mm)

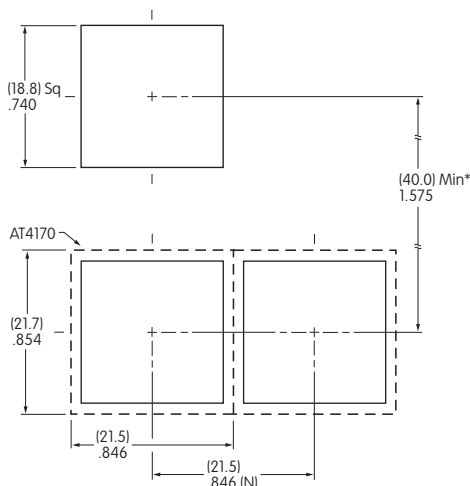
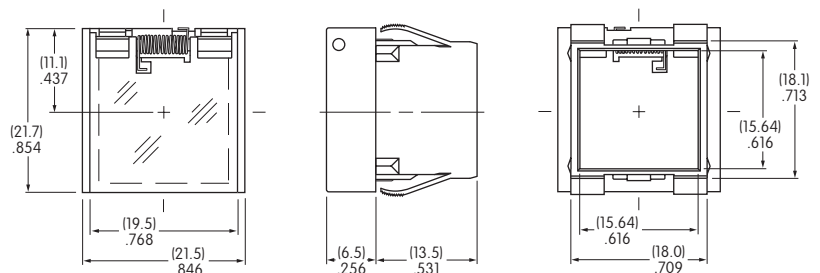

(N) = Number of switches

\* Minimum dimension allows opening of cover to 180°



#### Installation

- ① Install switch onto PC board.
- ② Snap protective guard into panel.
- ③ Join the two assemblies.

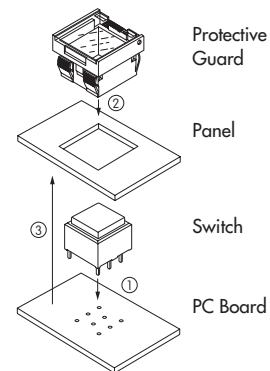

## OPTIONAL ACCESSORIES

### Spring Loaded Protective Guard for Snap-in Model

#### AT4142

Opens 180°  
Closes automatically



#### Materials:

Cover: Clear Polycarbonate  
Base: Black GFR Polyamide  
Coil Spring: Stainless Steel

#### Recommended Panel Thickness:

.039" ~ .106" (1.0mm ~ 2.7mm)

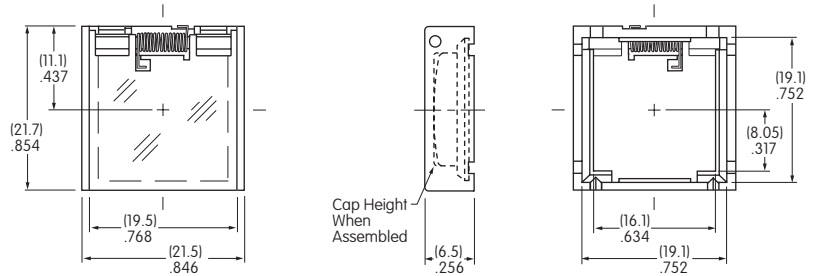

### Dust Cover

AT4145 Not for use with barriers.

#### Materials:

Lid: Clear PVC  
Operating temperature range:  
0°C ~ +70°C (32°F ~ 158°C).  
Gasket: Polyethylene



#### Recommended Panel Thickness

.039" ~ .098" (1.0mm ~ 2.5mm)

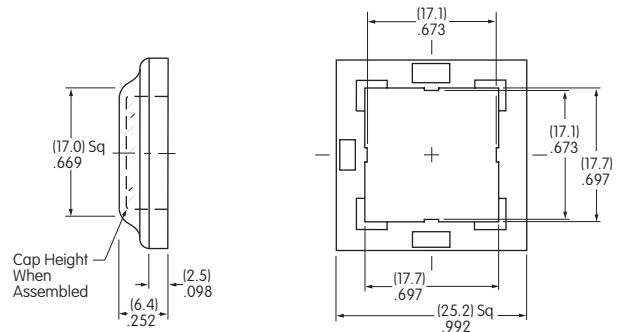

### Barriers for Snap-in Mount

#### AT4143 End

#### AT4144 Center



Cutouts for more than 1 Switch:

$$A = .799" (20.3\text{mm}) \times \text{Number of Switches} + .051" (1.3\text{mm})$$

Material: Polyamide

LEGENDS

NKK Switches can provide custom legends for caps. Contact factory for more information.

Suggested Printable Area for UB2 Lens, Film Insert or Diffuser

Recommended Methods: Laser Etch on clear lens, Screen Print or Pad Print on lens;  
Laser Print on film insert.

Shaded areas are printable areas.

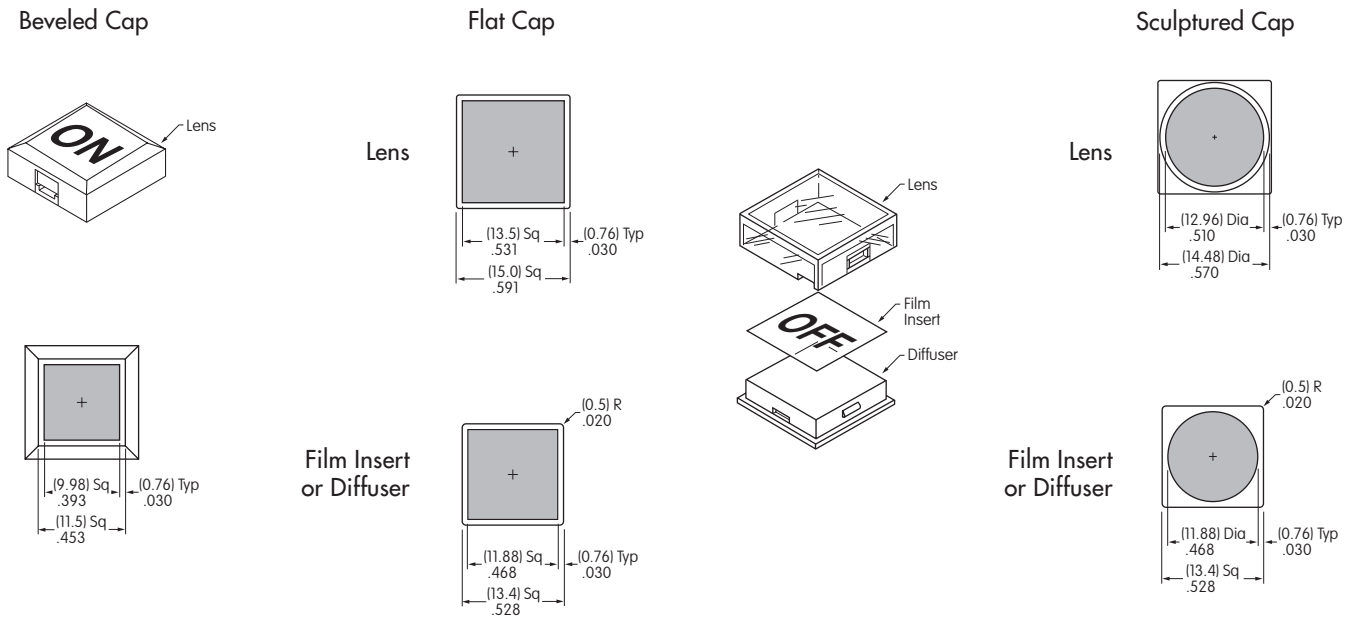

Film Insert: Clear Polyester 4 mil maximum thickness

Toggles  
Rocker  
Pushbuttons  
Illuminated PB  
Programmable  
Keylocks  
Rotaries  
Slides  
Tactiles  
Tilt  
Touch  
Indicators  
Accessories  
Supplement

## Данный компонент на территории Российской Федерации

### Вы можете приобрести в компании MosChip.

Для оперативного оформления запроса Вам необходимо перейти по данной ссылке:

<http://moschip.ru/get-element>

Вы можете разместить у нас заказ для любого Вашего проекта, будь то серийное производство или разработка единичного прибора.

В нашем ассортименте представлены ведущие мировые производители активных и пассивных электронных компонентов.

Нашей специализацией является поставка электронной компонентной базы двойного назначения, продукции таких производителей как XILINX, Intel (ex.ALTERA), Vicor, Microchip, Texas Instruments, Analog Devices, Mini-Circuits, Amphenol, Glenair.

Сотрудничество с глобальными дистрибьюторами электронных компонентов, предоставляет возможность заказывать и получать с международных складов практически любой перечень компонентов в оптимальные для Вас сроки.

На всех этапах разработки и производства наши партнеры могут получить квалифицированную поддержку опытных инженеров.

Система менеджмента качества компании отвечает требованиям в соответствии с ГОСТ Р ИСО 9001, ГОСТ РВ 0015-002 и ЭС РД 009

### Офис по работе с юридическими лицами:

105318, г.Москва, ул.Щербаковская д.3, офис 1107, 1118, ДЦ «Щербаковский»

Телефон: +7 495 668-12-70 (многоканальный)

Факс: +7 495 668-12-70 (доб.304)

E-mail: [info@moschip.ru](mailto:info@moschip.ru)

Skype отдела продаж:

moschip.ru

moschip.ru\_4

moschip.ru\_6

moschip.ru\_9