



The Future of Analog IC Technology™

PRELIMINARY RELEASE – SPECIFICATIONS SUBJECT TO CHANGE

MP1430

3A, 28V, 385KHz
Step-Down Converter

DESCRIPTION

The MP1430 is a step-down regulator with an internal Power MOSFET. It achieves 3A continuous output current over a wide input supply range with excellent load and line regulation.

Current mode operation provides fast transient response and eases loop stabilization.

Fault condition protection includes cycle-by-cycle current limiting and thermal shutdown. Adjustable soft-start reduces the stress on the input source at turn-on. In shutdown mode the regulator draws 20µA of supply current.

The MP1430 requires a minimum number of readily available external components to complete a 3A step down DC to DC converter solution.

EVALUATION BOARD REFERENCE

Board Number	Dimensions
EV1430DN-00A	2.1"X x 1.3"Y x 0.4"Z

FEATURES

- 3A Output Current
- Programmable Soft-Start
- 110mΩ Internal Power MOSFET Switch
- Stable with Low ESR Output Ceramic Capacitors
- Up to 95% Efficiency
- 20µA Shutdown Mode
- Fixed 385KHz Frequency
- Thermal Shutdown
- Cycle-by-Cycle Over Current Protection
- Wide 6V to 28V Operating Input Range
- Output Adjustable from 1.22V
- Under Voltage Lockout
- Available in 8-Pin SOIC Package

APPLICATIONS

- Distributed Power Systems
- Battery Chargers
- Pre-Regulator for Linear Regulators
- Flat Panel TVs
- Set-Top Boxes
- Cigarette Lighter Powered Devices
- DVD/PVR Devices

MPS® and "The Future of Analog IC Technology" are Trademarks of Monolithic Power Systems, Inc.

TYPICAL APPLICATION

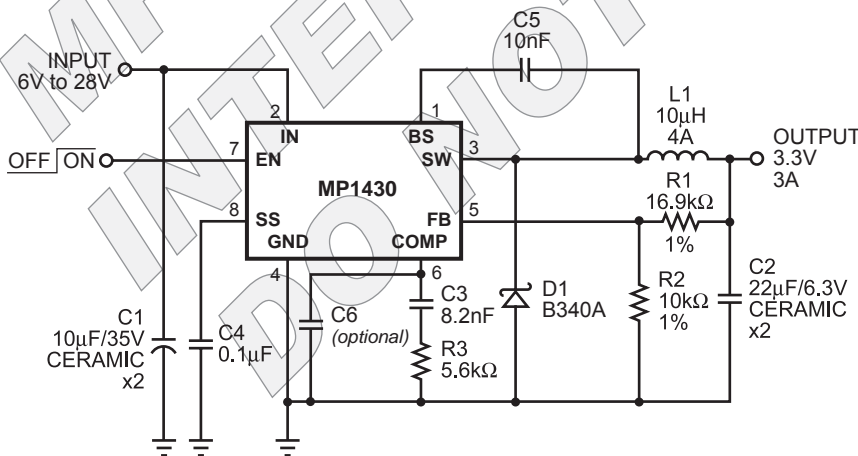

MP1430_TAC01

Efficiency vs Load Current

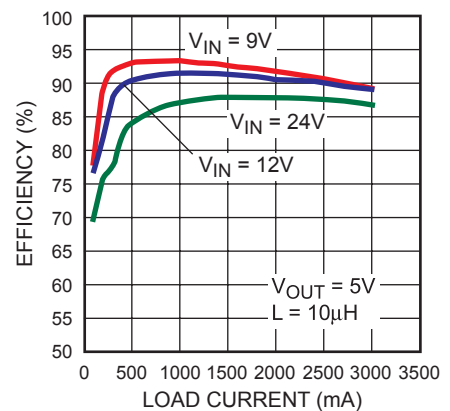

MP1430_TAC_EC01

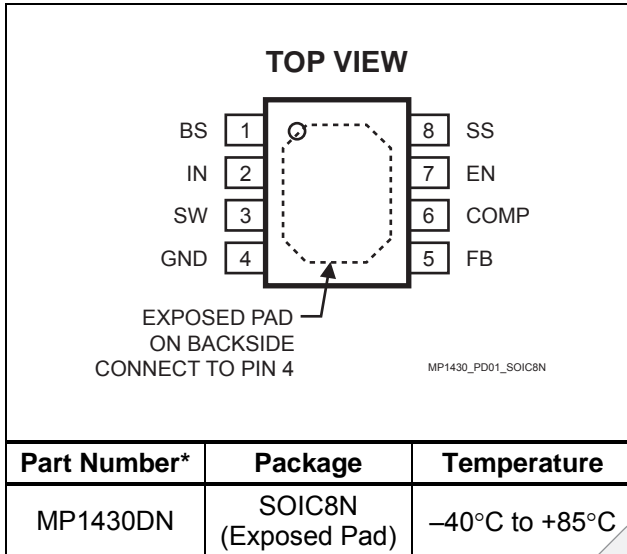
PACKAGE REFERENCE

* For Tape & Reel, add suffix -Z (eg. MP1430DN-Z)
 For Lead Free, add suffix -LF (eg. MP1430DN-LF-Z)

ABSOLUTE MAXIMUM RATINGS ⁽¹⁾

Supply Voltage V_{IN} -0.3V to 30V
 Switch Voltage V_{SW} -0.5V to $V_{IN} + 0.3V$
 Boost Voltage V_{BS} $V_{SW} - 0.3V$ to $V_{SW} + 6V$
 All Other Pins..... -0.3V to +6V
 Junction Temperature..... 150°C
 Lead Temperature..... 260°C
 Storage Temperature..... -65°C to 150°C

Recommended Operating Conditions ⁽²⁾

Input Voltage V_{IN} 6V to 28V
 Ambient Operating Temp..... -40°C to +85°C

Thermal Resistance ⁽³⁾ θ_{JA} θ_{JC}
 SOIC8N (w/Exposed Pad)..... 50..... 10..... °C/W

Notes:

- 1) Exceeding these ratings may damage the device.
- 2) The device is not guaranteed to function outside of its operating conditions.
- 3) Measured on approximately 1" square of 1 oz copper.

ELECTRICAL CHARACTERISTICS

$V_{IN} = 12V$, $T_A = +25^\circ C$, unless otherwise noted.

Parameter	Symbol	Condition	Min	Typ	Max	Units
Shutdown Supply Current		$V_{EN} = 0V$		20	30	μA
Supply Current		$V_{EN} = 2.6V$, $V_{FB} = 1.4V$		1.0	1.2	mA
Feedback Voltage	V_{FB}	$6V \leq V_{IN} \leq 28V$ $V_{COMP} < 2V$	1.194	1.222	1.250	V
Error Amplifier Voltage Gain	A_{EA}			400		V/V
Error Amplifier Transconductance	G_{EA}	$\Delta I_{COMP} = \pm 10\mu A$	500	800	1120	$\mu A/V$
High Side Switch On Resistance	$R_{DS(ON)1}$			110		m Ω
Low Side Switch On Resistance	$R_{DS(ON)2}$			10		Ω
High Side Switch Leakage Current		$V_{EN} = 0V$, $V_{SW} = 0V$		0	10	μA
Current Limit			3.3	4.5		A
Current Sense to COMP Transconductance	G_{CS}			6.2		A/V
Oscillation Frequency	f_{OSC1}		335	385	435	KHz
Short Circuit Oscillation Frequency	f_{OSC2}	$V_{FB} = 0V$	25	45	60	KHz
Maximum Duty Cycle	D_{MAX}	$V_{FB} = 1.0V$		90		%
Minimum Duty Cycle	D_{MIN}	$V_{FB} = 1.5V$			0	%

ELECTRICAL CHARACTERISTICS (continued)
 $V_{IN} = 12V, T_A = +25^{\circ}C$, unless otherwise noted.

Parameter	Symbol	Condition	Min	Typ	Max	Units
EN Threshold Voltage			0.9	1.2	1.5	V
Enable Pull Up Current		$V_{EN} = 0V$	1.0	1.7	2.5	μA
Under Voltage Lockout Threshold		V_{IN} Rising	2.3	2.6	2.9	V
Under Voltage Lockout Threshold Hysteresis				210		mV
Soft Start Period		$C_{SS} = 0.1\mu F$		10		ms
Thermal Shutdown				160		$^{\circ}C$

TYPICAL PERFORMANCE CHARACTERISTICS

Refer to Typical Application Schematic on Page 1

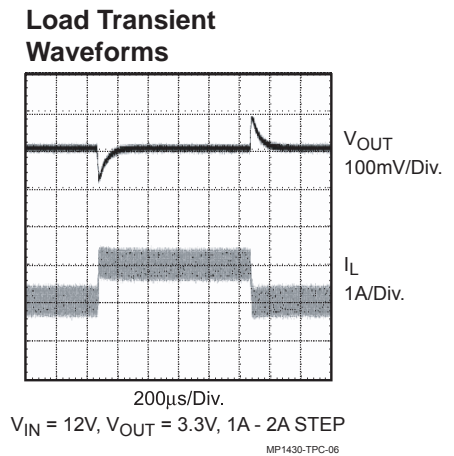
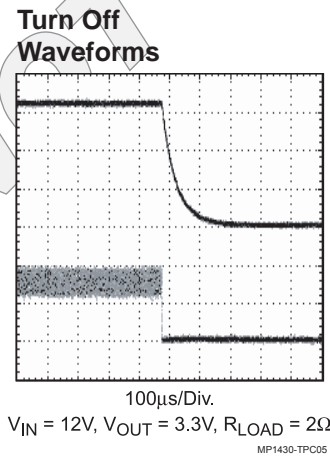
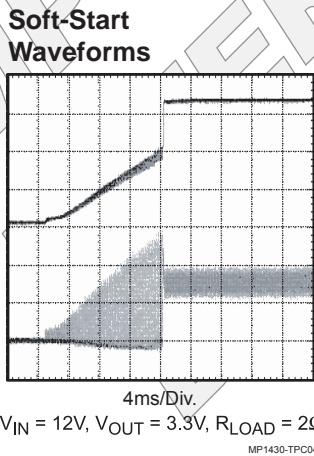
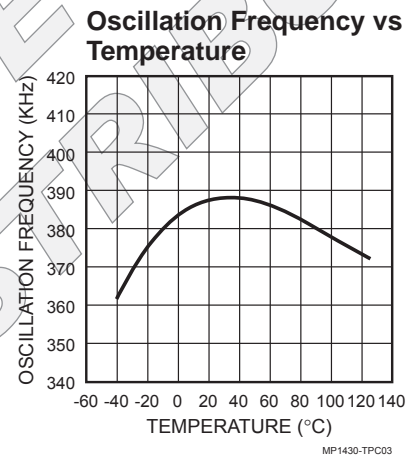
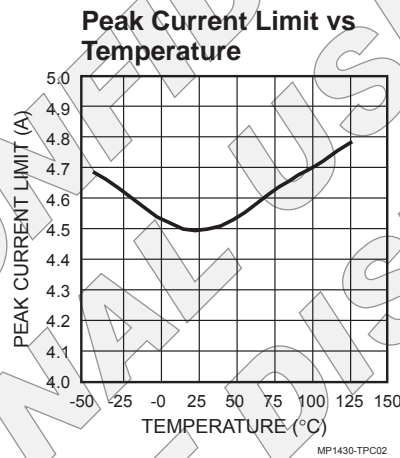
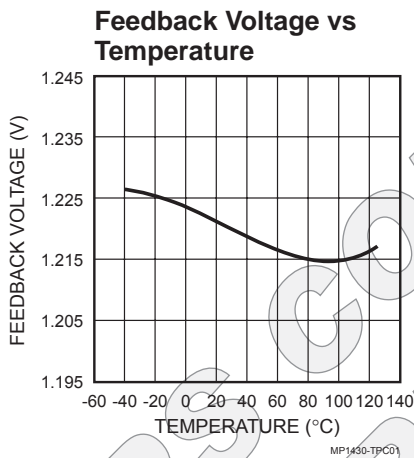

TYPICAL PERFORMANCE CHARACTERISTICS (continued)

Refer to Typical Application Schematic on Page 1

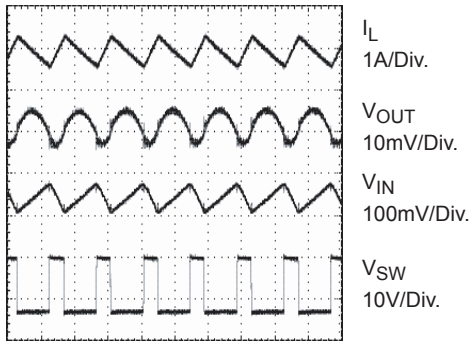
Switching Waveforms

 2 μ s/Div.

 $V_{IN} = 12V$, $V_{OUT} = 3.3V$, $R_{LOAD} = 2\Omega$

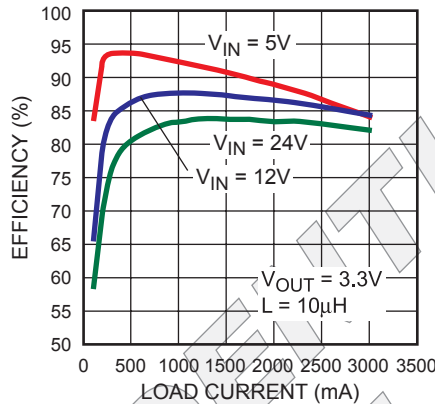
MP1430-TPC07

Efficiency vs Load Current

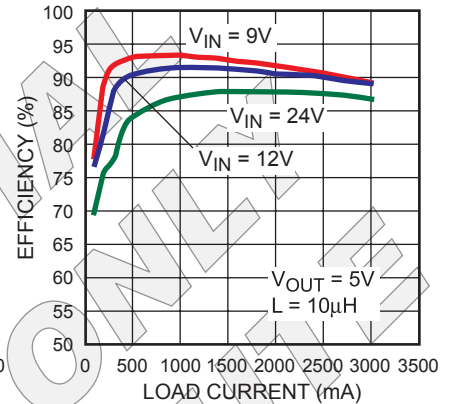
MP1430_TPC08

Efficiency vs Load Current

MP1430_TPC09

PIN FUNCTIONS

Pin #	Name	Description
1	BS	High-Side Gate Drive Boost Input. BS supplies the drive for the high-side N-Channel MOSFET switch. Connect a 10nF or greater capacitor from SW to BS to power the high side switch.
2	IN	Power Input. IN supplies the power to the IC, as well as the step-down converter switches. Drive IN with a 6V to 28V power source. Bypass IN to GND with a suitably large capacitor to eliminate noise on the input to the IC. See <i>Input Capacitor section</i> .
3	SW	Power Switching Output. SW is the switching node that supplies power to the output. Connect the output LC filter from SW to the output load. Note that a capacitor is required from SW to BS to power the high-side switch.
4	GND	Ground. (Note: Connect the exposed pad on backside to Pin 4).
5	FB	Feedback Input. FB senses the output voltage to regulate that voltage. Drive FB with a resistive voltage divider from the output voltage. The feedback threshold is 1.222V. See <i>Setting the Output Voltage section</i> .
6	COMP	Compensation Node. COMP is used to compensate the regulation control loop. Connect a series RC network from COMP to GND to compensate the regulation control loop. In some cases, an additional capacitor from COMP to GND is required. See <i>Compensation section</i> .
7	EN	Enable Input. EN is a digital input that turns the regulator on or off. Drive EN high to turn on the regulator, drive EN low to turn it off. An Under Voltage Lockout (UVLO) function can be implemented by the addition of a resistor divider from V_{IN} to GND. For complete low current shutdown its needs to be less than 0.7V. For automatic startup, leave EN unconnected.
8	SS	Soft-Start Control Input. SS controls the soft-start period. Connect a capacitor from SS to GND to set the soft-start period. A 0.1 μ F capacitor sets the soft-start period to 10ms. To disable the soft-start feature, leave SS unconnected.

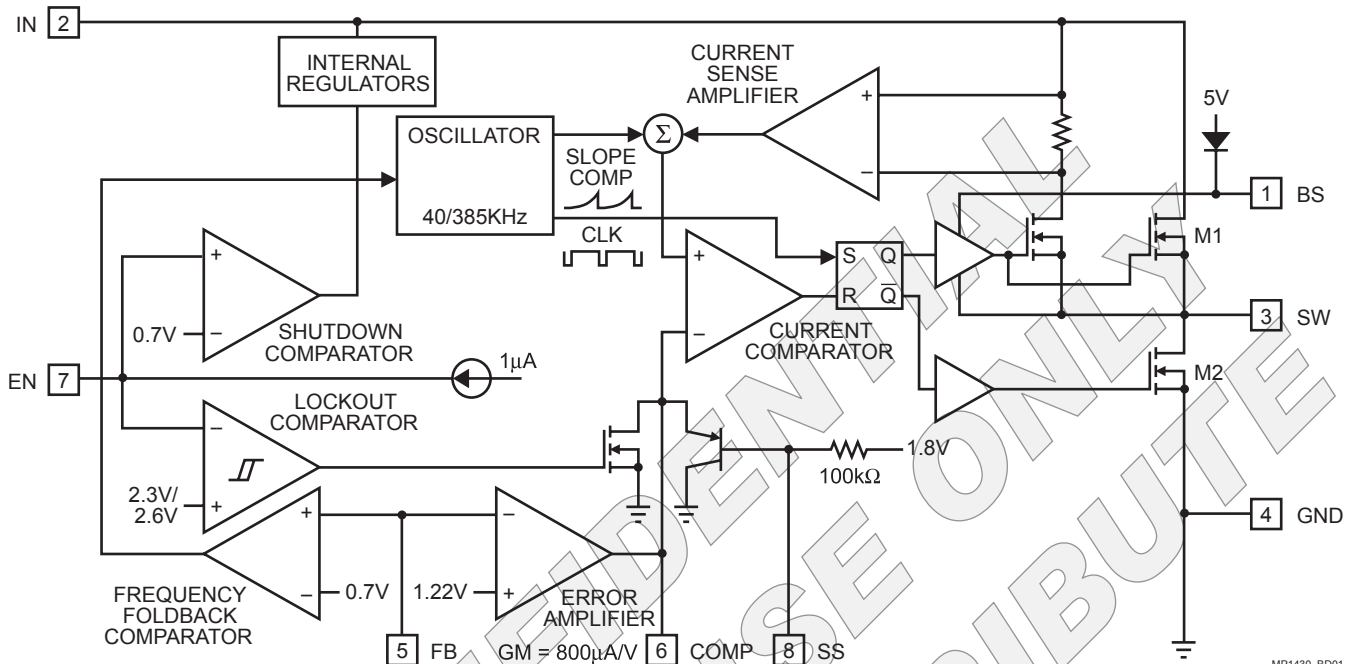
OPERATION

Figure 1—Functional Block Diagram

The MP1430 is a current-mode step-down regulator. It regulates input voltages from 6V to 28V down to an output voltage as low as 1.22V, and is able to supply up to 3A of load current.

The MP1430 uses current-mode control to regulate the output voltage. The output voltage is measured at FB through a resistive voltage divider and amplified through the internal error amplifier. The output current of the transconductance error amplifier is presented at COMP where a network compensates the regulation control system. The voltage at COMP is compared to the switch current measured internally to control the output voltage.

The converter uses an internal N-Channel MOSFET switch to step-down the input voltage to the regulated output voltage. Since the MOSFET requires a gate voltage greater than the input voltage, a boost capacitor connected between SW and BS drives the gate. The capacitor is internally charged while SW is low.

An internal 10Ω switch from SW to GND is used to insure that SW is pulled to GND when SW is low to fully charge the BS capacitor.

APPLICATION INFORMATION

COMPONENT SELECTION

Setting the Output Voltage

The output voltage is set using a resistive voltage divider from the output voltage to FB pin. The voltage divider divides the output voltage down to the feedback voltage by the ratio:

$$V_{FB} = V_{OUT} \frac{R2}{R1 + R2}$$

Where V_{FB} is the feedback voltage and V_{OUT} is the output voltage.

Thus the output voltage is:

$$V_{OUT} = 1.22 \times \frac{R1 + R2}{R2}$$

A typical value for R2 can be as high as 100k Ω , but a typical value is 10k Ω . Using that value, R1 is determined by:

$$R1 = 8.18 \times (V_{OUT} - 1.22)(k\Omega)$$

For example, for a 3.3V output voltage, R2 is 10k Ω , and R1 is 17k Ω .

Inductor

The inductor is required to supply constant current to the output load while being driven by the switched input voltage. A larger value inductor will result in less ripple current that will result in lower output ripple voltage. However, the larger value inductor will have a larger physical size, higher series resistance, and/or lower saturation current. A good rule for determining the inductance to use is to allow the peak-to-peak ripple current in the inductor to be approximately 30% of the maximum switch current limit. Also, make sure that the peak inductor current is below the maximum switch current limit. The inductance value can be calculated by:

$$L = \frac{V_{OUT}}{f_s \times \Delta I_L} \times \left(1 - \frac{V_{OUT}}{V_{IN}} \right)$$

Where V_{IN} is the input voltage, f_s is the 385KHz switching frequency, and ΔI_L is the peak-to-peak inductor ripple current.

Choose an inductor that will not saturate under the maximum inductor peak current. The peak inductor current can be calculated by:

$$I_{LP} = I_{LOAD} + \frac{V_{OUT}}{2 \times f_s \times L} \times \left(1 - \frac{V_{OUT}}{V_{IN}} \right)$$

Where I_{LOAD} is the load current.

Table 1 lists a number of suitable inductors from various manufacturers. The choice of which style inductor to use mainly depends on the price vs. size requirements and any EMI requirement.

Table 1—Inductor Selection Guide

Vendor/ Model	Core Type	Core Material	Package Dimensions (mm)		
			W	L	H
Sumida					
CR75	Open	Ferrite	7.0	7.8	5.5
CDH74	Open	Ferrite	7.3	8.0	5.2
CDRH5D28	Shielded	Ferrite	5.5	5.7	5.5
CDRH5D28	Shielded	Ferrite	5.5	5.7	5.5
CDRH6D28	Shielded	Ferrite	6.7	6.7	3.0
CDRH104R	Shielded	Ferrite	10.1	10.0	3.0
Toko					
D53LC Type A	Shielded	Ferrite	5.0	5.0	3.0
D75C	Shielded	Ferrite	7.6	7.6	5.1
D104C	Shielded	Ferrite	10.0	10.0	4.3
D10FL	Open	Ferrite	9.7	1.5	4.0
Coilcraft					
DO3308	Open	Ferrite	9.4	13.0	3.0
DO3316	Open	Ferrite	9.4	13.0	5.1

Output Rectifier Diode

The output rectifier diode supplies the current to the inductor when the high-side switch is off. To reduce losses due to the diode forward voltage and recovery times, use a Schottky diode.

Choose a diode whose maximum reverse voltage rating is greater than the maximum input voltage, and whose current rating is greater than the maximum load current. Table 2 lists example Schottky diodes and manufacturers.

Table 2—Diode Selection Guide

Diode	Voltage/Current Rating	Manufacturer
SK33	30V, 3A	Diodes Inc.
SK34	40V, 3A	Diodes Inc.
B330	30V, 3A	Diodes Inc.
B340	40V, 3A	Diodes Inc.
MBRS330	30V, 3A	On Semiconductor
MBRS340	40V, 3A	On Semiconductor

Input Capacitor

The input current to the step-down converter is discontinuous, therefore a capacitor is required to supply the AC current to the step-down converter while maintaining the DC input voltage. Use low ESR capacitors for the best performance. Ceramic capacitors are preferred, but tantalum or low-ESR electrolytic capacitors may also suffice.

Since the input capacitor absorbs the input switching current it requires an adequate ripple current rating. The RMS current in the input capacitor can be estimated by:

$$I_{CIN} = I_{LOAD} \times \sqrt{\frac{V_{OUT}}{V_{IN}} \times \left(1 - \frac{V_{OUT}}{V_{IN}}\right)}$$

The worst-case condition occurs at $V_{IN} = 2V_{OUT}$, where:

$$I_{CIN} = \frac{I_{LOAD}}{2}$$

For simplification, choose the input capacitor whose RMS current rating greater than half of the maximum load current.

The input capacitor can be electrolytic, tantalum or ceramic. When using electrolytic or tantalum capacitors, a small, high quality ceramic capacitor, i.e. 0.1 μ F, should be placed as close to the IC as possible. When using ceramic capacitors, make sure that they have enough capacitance to provide sufficient charge to prevent excessive voltage ripple at input. The input voltage ripple caused by capacitance can be estimated by:

$$\Delta V_{IN} = \frac{I_{LOAD}}{f_s \times C_{IN}} \times \frac{V_{OUT}}{V_{IN}} \times \left(1 - \frac{V_{OUT}}{V_{IN}}\right)$$

Where C_{IN} is the input capacitance value.

Output Capacitor

The output capacitor is required to maintain the DC output voltage. Ceramic, tantalum, or low ESR electrolytic capacitors are recommended.

Low ESR capacitors are preferred to keep the output voltage ripple low. The output voltage ripple can be estimated by:

$$\Delta V_{OUT} = \frac{V_{OUT}}{f_s \times L} \times \left(1 - \frac{V_{OUT}}{V_{IN}}\right) \times \left(R_{ESR} + \frac{1}{8 \times f_s \times C_O}\right)$$

Where L is the inductor value, C_O is the output capacitance value, and R_{ESR} is the equivalent series resistance (ESR) value of the output capacitor.

In the case of ceramic capacitors, the impedance at the switching frequency is dominated by the capacitance. The output voltage ripple is mainly caused by the capacitance. For simplification, the output voltage ripple can be estimated by:

$$\Delta V_{OUT} = \frac{V_{OUT}}{8 \times f_s^2 \times L \times C_O} \times \left(1 - \frac{V_{OUT}}{V_{IN}}\right)$$

In the case of tantalum or electrolytic capacitors, the ESR dominates the impedance at the switching frequency. For simplification, the output ripple can be approximated to:

$$\Delta V_{OUT} = \frac{V_{OUT}}{f_s \times L} \times \left(1 - \frac{V_{OUT}}{V_{IN}}\right) \times R_{ESR}$$

The characteristics of the output capacitor also affect the stability of the regulation system. The MP1430 can be optimized for a wide range of capacitance and ESR values.

Compensation Components

MP1430 employs current mode control for easy compensation and fast transient response. The system stability and transient response are controlled through the COMP pin. COMP pin is the output of the internal transconductance error amplifier. A series capacitor-resistor combination sets a pole-zero combination to control the characteristics of the control system.

The DC gain of the voltage feedback loop is given by:

$$A_{VDC} = R_{LOAD} \times G_{CS} \times A_{VEA} \times \frac{V_{FB}}{V_{OUT}}$$

Where A_{VEA} is the error amplifier voltage gain, 400V/V, G_{CS} is the current sense transconductance, 5.9A/V, and R_{LOAD} is the load resistor value.

The system has two poles of importance. One is due to the compensation capacitor (C3) and the output resistor of error amplifier, and the other is due to the output capacitor and the load resistor. These poles are located at:

$$f_{P1} = \frac{G_{EA}}{2\pi \times C3 \times A_{VEA}}$$

$$f_{P2} = \frac{1}{2\pi \times C_O \times R_{LOAD}}$$

Where G_{EA} is the error amplifier transconductance, 800 μ A/V.

The system has one zero of importance, due to the compensation capacitor (C3) and the compensation resistor (R3). This zero is located at:

$$f_{Z1} = \frac{1}{2\pi \times C3 \times R3}$$

The system may have another zero of importance, if the output capacitor has a large capacitance and/or a high ESR value. The zero, due to the ESR and capacitance of the output capacitor, is located at:

$$f_{ESR} = \frac{1}{2\pi \times C_O \times R_{ESR}}$$

In this case (as shown in Figure 3), a third pole set by the compensation capacitor (C6) and the compensation resistor (R3) is used to compensate the effect of the ESR zero on the loop gain. This pole is located at:

$$f_{P3} = \frac{1}{2\pi \times C6 \times R3}$$

The goal of compensation design is to shape the converter transfer function to get a desired loop gain. The system crossover frequency where the feedback loop has the unity gain is important.

Lower crossover frequencies result in slower line and load transient responses, while higher crossover frequencies could cause system unstable. A good rule of thumb is to set the crossover frequency to approximately one-tenth of the switching frequency. Switching frequency for the MP1430 is 385KHz, so the desired crossover frequency is around 38KHz.

Table 3 lists the typical values of compensation components for some standard output voltages with various output capacitors and inductors. The values of the compensation components have been optimized for fast transient responses and good stability at given conditions.

Table 3—Compensation Values for Typical Output Voltage/Capacitor Combinations

V _{OUT}	L	C _O	R3	C3	C6
1.8V	4.7μH	100μF Ceramic	5.6kΩ	3.3nF	None
2.5V	4.7-6.8μH	47μF Ceramic	3.9kΩ	5.6nF	None
3.3V	6.8-10μH	22μF×2 Ceramic	5.6kΩ	8.2nF	None
5V	10-15μH	22μF×2 Ceramic	7.5kΩ	10nF	None
12V	15-22μH	22μF×2 Ceramic	10kΩ	3.3nF	None
1.8	4.7μH	100μF SP-CAP	5.6kΩ	3.3nF	100pF
2.5V	4.7-6.8μH	47μF SP-CAP	4.7kΩ	5.6nF	None
3.3V	6.8-10μH	47μF SP-CAP	6.8kΩ	10nF	None
5V	10-15μH	47μF SP CAP	10kΩ	10nF	None
2.5V	4.7-6.8μH	560μF Al. 30mΩ ESR	10kΩ	5.6nF	1.5nF
3.3V	6.8-10μH	560μF Al 30mΩ ESR	10kΩ	8.2nF	1.5nF
5V	10-15μH	470μF Al. 30mΩ ESR	15kΩ	5.6nF	1nF
12V	15-22μH	220μF Al. 30mΩ ESR	15kΩ	4.7nF	390pF

To optimize the compensation components for conditions not listed in Table 3, the following procedure can be used.

1. Choose the compensation resistor (R3) to set the desired crossover frequency. Determine the R3 value by the following equation:

$$R3 = \frac{2\pi \times C_O \times f_C}{G_{EA} \times G_{CS}} \times \frac{V_{OUT}}{V_{FB}}$$

Where f_C is the desired crossover frequency (which typically has a value no higher than 38KHz).

2. Choose the compensation capacitor (C3) to achieve the desired phase margin. For applications with typical inductor values, setting the compensation zero, f_{Z1} , below one fourth of the crossover frequency provides sufficient phase margin.

Determine the C3 value by the following equation:

$$C3 > \frac{4}{2\pi \times R3 \times f_C}$$

Where, R3 is the compensation resistor value and f_C is the desired crossover frequency, 38KHz.

3. Determine if the second compensation capacitor (C6) is required. It is required if the ESR zero of the output capacitor is located at less than half of the 385KHz switching frequency, or the following relationship is valid:

$$\frac{1}{2\pi \times C_O \times R_{ESR}} < \frac{f_S}{2}$$

Where, C_O is the output capacitance value, R_{ESR} is the ESR value of the output capacitor, and f_S is the 385KHz switching frequency. If this is the case, then add the second compensation capacitor (C6) to set the pole f_{P3} at the location of the ESR zero. Determine the C6 value by the equation:

$$C6 = \frac{C_O \times R_{ESR}}{R3}$$

Where, C_O is the output capacitance value, R_{ESR} is the ESR value of the output capacitor, and R3 is the compensation resistor.

External Bootstrap Diode

It is recommended that an external bootstrap diode be added when the system has a 5V fixed input or the power supply generates a 5V output. This helps improve the efficiency of the regulator. The bootstrap diode can be a low cost one such as IN4148 or BAT54.

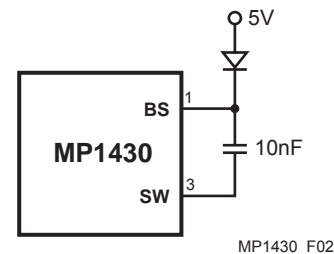
Figure 2—External Bootstrap Diode

This diode is also recommended for high duty cycle operation (when $\frac{V_{OUT}}{V_{IN}} > 65\%$) and high output voltage ($V_{OUT} > 12V$) applications.

TYPICAL APPLICATION CIRCUITS

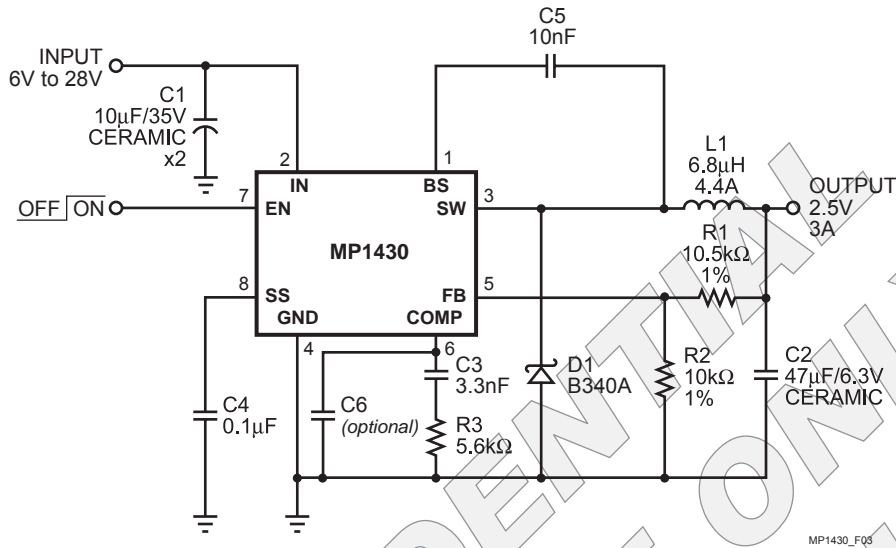

Figure 3—MP1430 with AVX 47µF, 6.3V Ceramic Output Capacitor

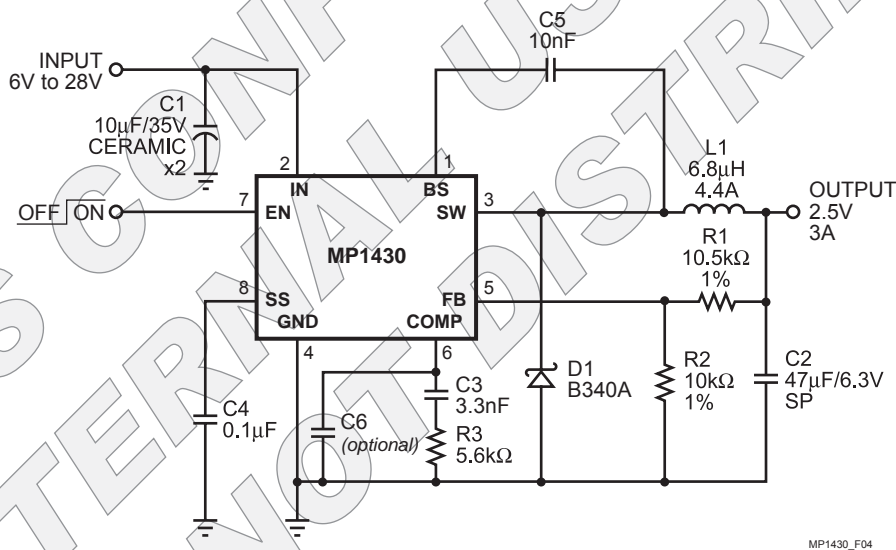
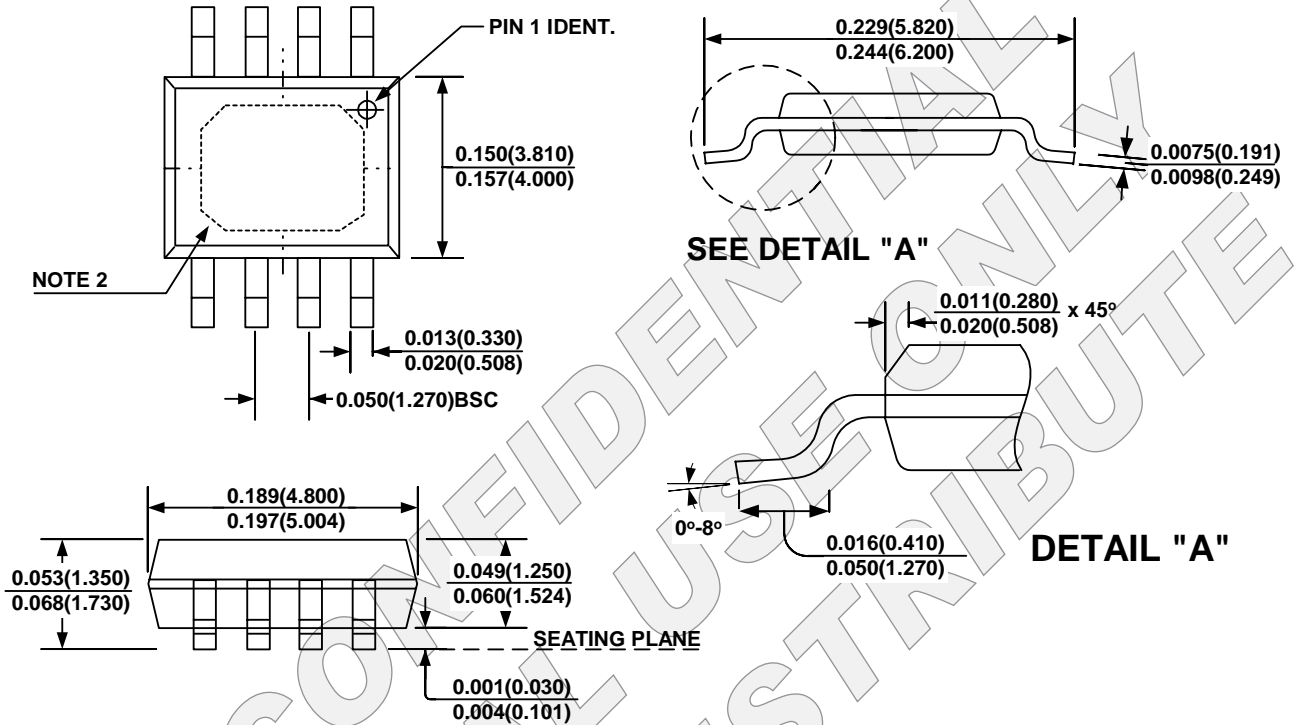

Figure 4—MP1430 with Panasonic 47µF, 6.3V Special Polymer Output Capacitor

PACKAGE INFORMATION

SOIC8N (EXPOSED PAD)



NOTE:

- 1) Control dimension is in inches. Dimension in bracket is millimeters.
- 2) Exposed Pad; 2.55 +/- 0.25mm x 3.38 +/- 0.44mm.
Recommended Solder Board Area: 2.80mm x 3.82mm = 10.7mm² (16.6mil²)

NOTICE: The information in this document is subject to change without notice. Please contact MPS for current specifications. Users should warrant and guarantee that third party Intellectual Property rights are not infringed upon when integrating MPS products into any application. MPS will not assume any legal responsibility for any said applications.

Данный компонент на территории Российской Федерации

Вы можете приобрести в компании MosChip.

Для оперативного оформления запроса Вам необходимо перейти по данной ссылке:

<http://moschip.ru/get-element>

Вы можете разместить у нас заказ для любого Вашего проекта, будь то серийное производство или разработка единичного прибора.

В нашем ассортименте представлены ведущие мировые производители активных и пассивных электронных компонентов.

Нашей специализацией является поставка электронной компонентной базы двойного назначения, продукции таких производителей как XILINX, Intel (ex.ALTERA), Vicor, Microchip, Texas Instruments, Analog Devices, Mini-Circuits, Amphenol, Glenair.

Сотрудничество с глобальными дистрибьюторами электронных компонентов, предоставляет возможность заказывать и получать с международных складов практически любой перечень компонентов в оптимальные для Вас сроки.

На всех этапах разработки и производства наши партнеры могут получить квалифицированную поддержку опытных инженеров.

Система менеджмента качества компании отвечает требованиям в соответствии с ГОСТ Р ИСО 9001, ГОСТ РВ 0015-002 и ЭС РД 009

Офис по работе с юридическими лицами:

105318, г.Москва, ул.Щербаковская д.3, офис 1107, 1118, ДЦ «Щербаковский»

Телефон: +7 495 668-12-70 (многоканальный)

Факс: +7 495 668-12-70 (доб.304)

E-mail: info@moschip.ru

Skype отдела продаж:

moschip.ru

moschip.ru_4

moschip.ru_6

moschip.ru_9