

IRG4BC20SPbF

INSULATED GATE BIPOLAR TRANSISTOR

Standard Speed IGBT

Features

- Standard: optimized for minimum saturation voltage and low operating frequencies (< 1kHz)
- Generation 4 IGBT design provides tighter parameter distribution and higher efficiency than Generation 3
- Industry standard TO-220AB package
- Lead-Free

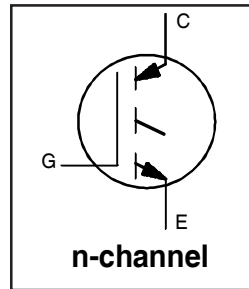

$V_{CES} = 600V$
$V_{CE(on) typ.} = 1.4V$
@ $V_{GE} = 15V, I_C = 10A$

Benefits

- Generation 4 IGBTs offer highest efficiency available
- IGBTs optimized for specified application conditions
- Designed to be a "drop-in" replacement for equivalent industry-standard Generation 3 IR IGBTs

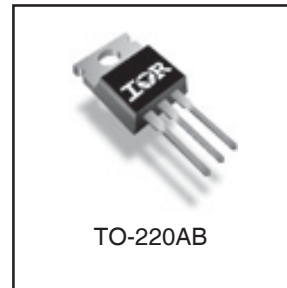

Absolute Maximum Ratings

	Parameter	Max.	Units
V_{CES}	Collector-to-Emitter Breakdown Voltage	600	V
$I_C @ T_C = 25^\circ C$	Continuous Collector Current	19	A
$I_C @ T_C = 100^\circ C$	Continuous Collector Current	10	
I_{CM}	Pulsed Collector Current ①	38	
I_{LM}	Clamped Inductive Load Current ②	38	
V_{GE}	Gate-to-Emitter Voltage	± 20	V
E_{ARV}	Reverse Voltage Avalanche Energy ③	5.0	mJ
$P_D @ T_C = 25^\circ C$	Maximum Power Dissipation	60	W
$P_D @ T_C = 100^\circ C$	Maximum Power Dissipation	24	
T_J	Operating Junction and	-55 to + 150	°C
T_{STG}	Storage Temperature Range		
	Soldering Temperature, for 10 seconds	300 (0.063 in. (1.6mm) from case)	
	Mounting torque, 6-32 or M3 screw.	10 lbf•in (1.1N•m)	

Thermal Resistance

	Parameter	Typ.	Max.	Units
$R_{\theta JC}$	Junction-to-Case	---	2.1	°C/W
$R_{\theta CS}$	Case-to-Sink, Flat, Greased Surface	0.50	---	
$R_{\theta JA}$	Junction-to-Ambient, typical socket mount	---	80	
Wt	Weight	2.0 (0.07)	---	g (oz)

IRG4BC20SPbF

Electrical Characteristics @ $T_J = 25^\circ\text{C}$ (unless otherwise specified)

	Parameter	Min.	Typ.	Max.	Units	Conditions
$V_{(BR)CES}$	Collector-to-Emitter Breakdown Voltage	600	—	—	V	$V_{GE} = 0V, I_C = 250\mu A$
$V_{(BR)ECS}$	Emitter-to-Collector Breakdown Voltage ④	18	—	—	V	$V_{GE} = 0V, I_C = 1.0A$
$\Delta V_{(BR)CES}/\Delta T_J$	Temperature Coeff. of Breakdown Voltage	—	0.75	—	V/°C	$V_{GE} = 0V, I_C = 1.0mA$
$V_{CE(ON)}$	Collector-to-Emitter Saturation Voltage	—	1.40	1.6	V	$I_C = 10A$ $I_C = 19A$ $I_C = 10A, T_J = 150^\circ\text{C}$ $V_{GE} = 15V$ See Fig.2, 5
		—	1.85	—		
		—	1.44	—		
$V_{GE(th)}$	Gate Threshold Voltage	3.0	—	6.0		$V_{CE} = V_{GE}, I_C = 250\mu A$
$\Delta V_{GE(th)}/\Delta T_J$	Temperature Coeff. of Threshold Voltage	—	-11	—	mV/°C	$V_{CE} = V_{GE}, I_C = 250\mu A$
g_{fe}	Forward Transconductance ⑤	2.0	5.8	—	S	$V_{CE} = 100V, I_C = 10A$
I_{CES}	Zero Gate Voltage Collector Current	—	—	250	μA	$V_{GE} = 0V, V_{CE} = 600V$ $V_{GE} = 0V, V_{CE} = 10V, T_J = 25^\circ\text{C}$ $V_{GE} = 0V, V_{CE} = 600V, T_J = 150^\circ\text{C}$
		—	—	2.0		
		—	—	1000		
I_{GES}	Gate-to-Emitter Leakage Current	—	—	± 100	nA	$V_{GE} = \pm 20V$

Switching Characteristics @ $T_J = 25^\circ\text{C}$ (unless otherwise specified)

	Parameter	Min.	Typ.	Max.	Units	Conditions
Q_g	Total Gate Charge (turn-on)	—	27	40	nC	$I_C = 10A$ $V_{CC} = 400V$ $V_{GE} = 15V$ See Fig. 8
Q_{ge}	Gate - Emitter Charge (turn-on)	—	4.3	6.5		
Q_{gc}	Gate - Collector Charge (turn-on)	—	10	15		
$t_{d(on)}$	Turn-On Delay Time	—	27	—	ns	$T_J = 25^\circ\text{C}$ $I_C = 10A, V_{CC} = 480V$ $V_{GE} = 15V, R_G = 50\Omega$ Energy losses include "tail" See Fig. 9, 10, 14
t_r	Rise Time	—	9.7	—		
$t_{d(off)}$	Turn-Off Delay Time	—	540	810		
t_f	Fall Time	—	430	640		
E_{on}	Turn-On Switching Loss	—	0.12	—	mJ	See Fig. 9, 10, 14
E_{off}	Turn-Off Switching Loss	—	2.05	—		
E_{ts}	Total Switching Loss	—	2.17	3.2		
$t_{d(on)}$	Turn-On Delay Time	—	25	—	ns	$T_J = 150^\circ\text{C},$ $I_C = 10A, V_{CC} = 480V$ $V_{GE} = 15V, R_G = 50\Omega$ Energy losses include "tail" See Fig. 11, 14
t_r	Rise Time	—	13	—		
$t_{d(off)}$	Turn-Off Delay Time	—	760	—		
t_f	Fall Time	—	780	—		
E_{ts}	Total Switching Loss	—	3.46	—	mJ	
L_E	Internal Emitter Inductance	—	7.5	—	nH	Measured 5mm from package
C_{ies}	Input Capacitance	—	550	—	pF	$V_{GE} = 0V$ $V_{CC} = 30V$ $f = 1.0MHz$ See Fig. 7
C_{oes}	Output Capacitance	—	39	—		
C_{res}	Reverse Transfer Capacitance	—	7.1	—		

Notes:

- ① Repetitive rating; $V_{GE} = 20V$, pulse width limited by max. junction temperature. (See fig. 13b)
- ② $V_{CC} = 80\%(V_{CES}), V_{GE} = 20V, L = 10\mu H, R_G = 50\Omega,$ (See fig. 13a)
- ③ Repetitive rating; pulse width limited by maximum junction temperature.
- ④ Pulse width $\leq 80\mu s$; duty factor $\leq 0.1\%$.
- ⑤ Pulse width $5.0\mu s$, single shot.

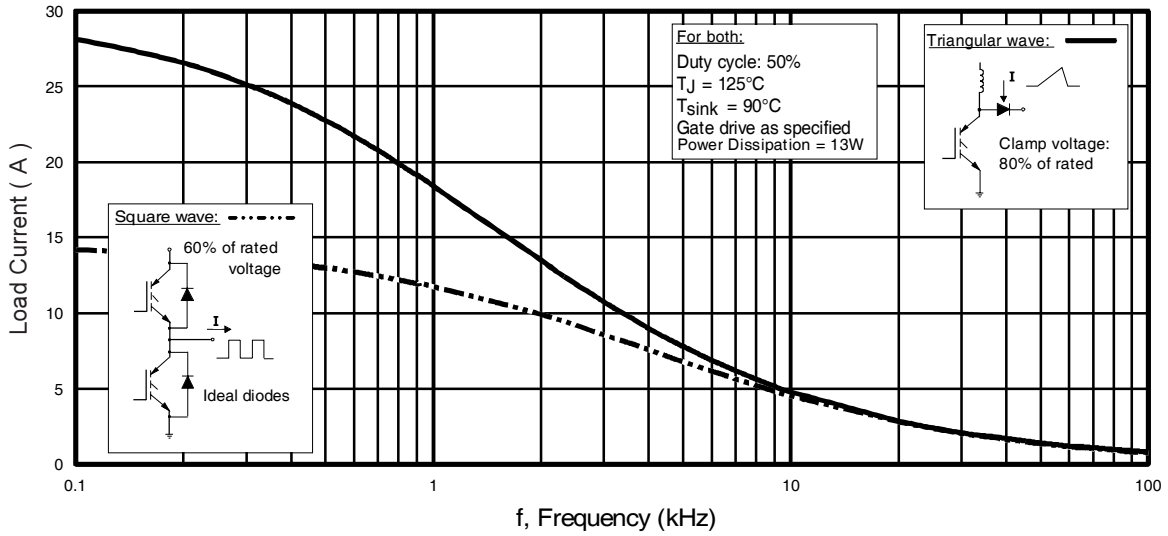

Fig. 1 - Typical Load Current vs. Frequency
(Load Current = I_{RMS} of fundamental)

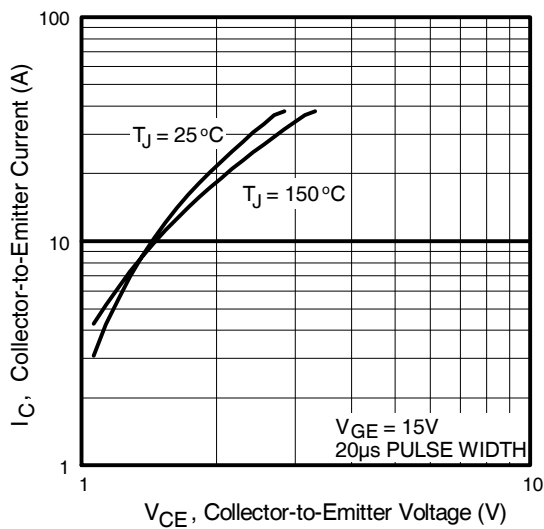

Fig. 2 - Typical Output Characteristics

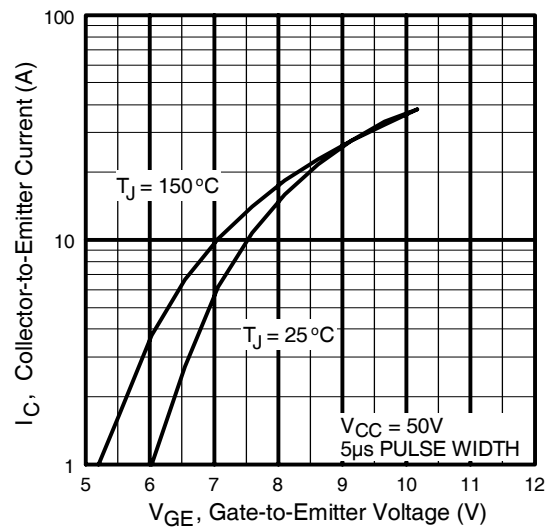

Fig. 3 - Typical Transfer Characteristics

IRG4BC20SPbF

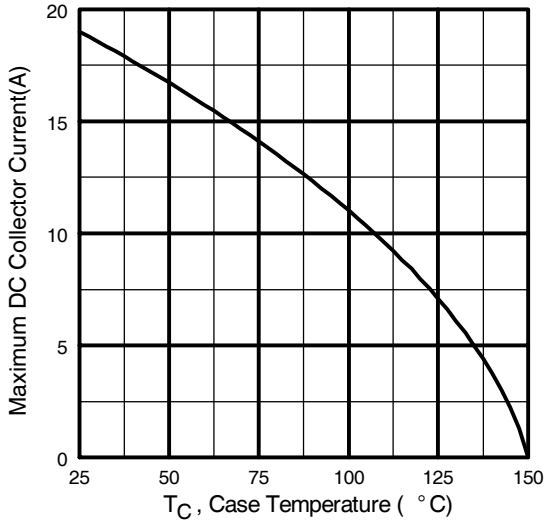

Fig. 4 - Maximum Collector Current vs. Case Temperature

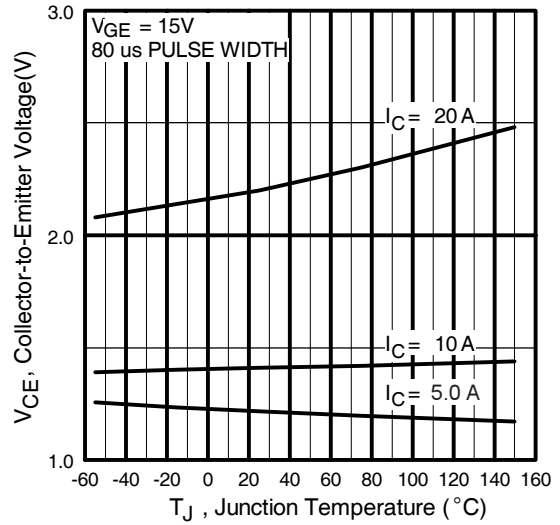

Fig. 5 - Typical Collector-to-Emitter Voltage vs. Junction Temperature

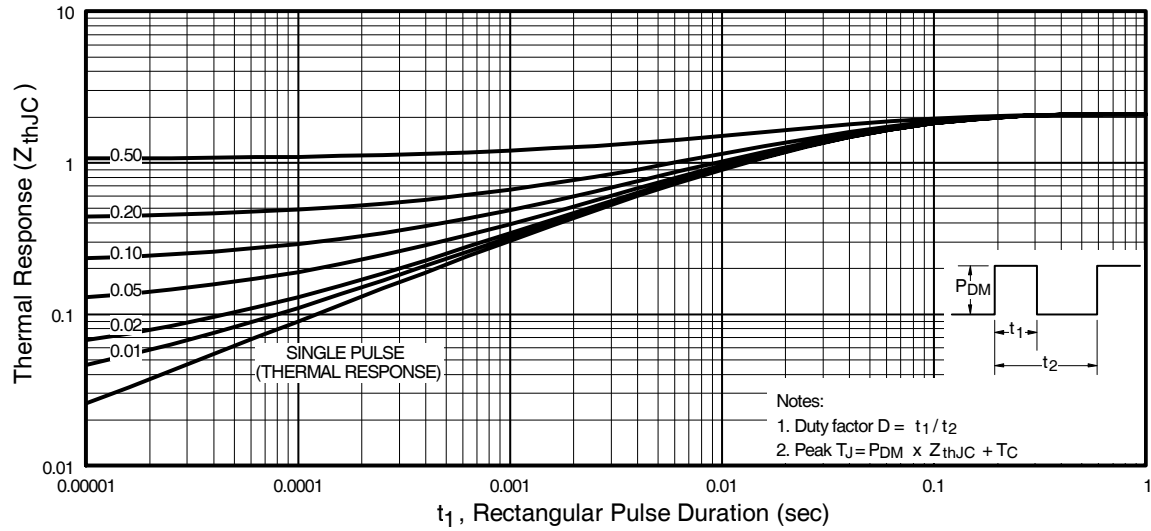

Fig. 6 - Maximum Effective Transient Thermal Impedance, Junction-to-Case

IRG4BC20SPbF

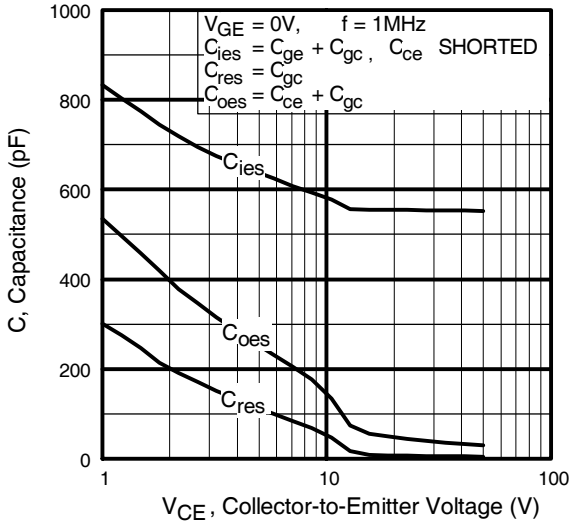

Fig. 7 - Typical Capacitance vs. Collector-to-Emitter Voltage

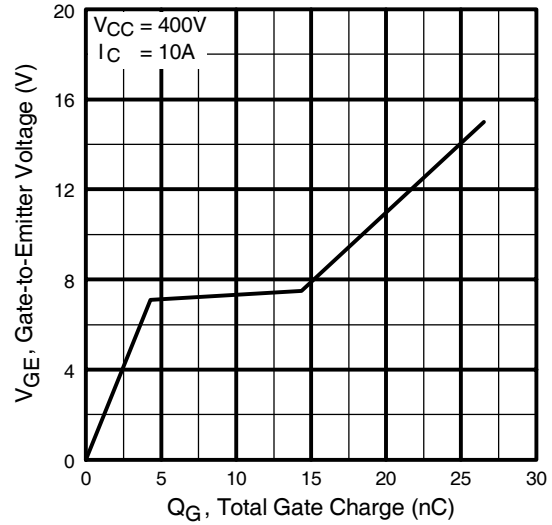

Fig. 8 - Typical Gate Charge vs. Gate-to-Emitter Voltage

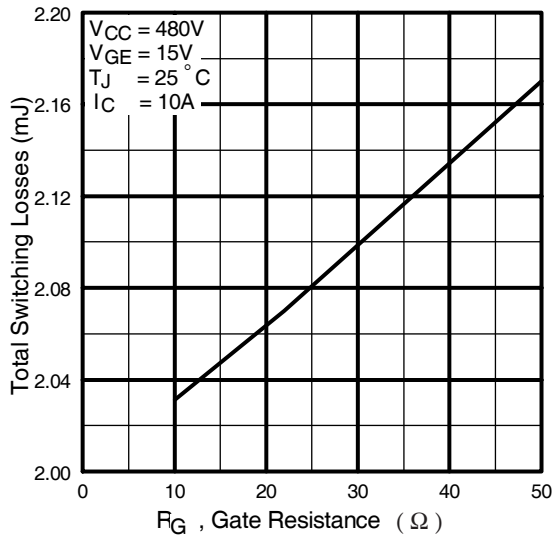

Fig. 9 - Typical Switching Losses vs. Gate Resistance

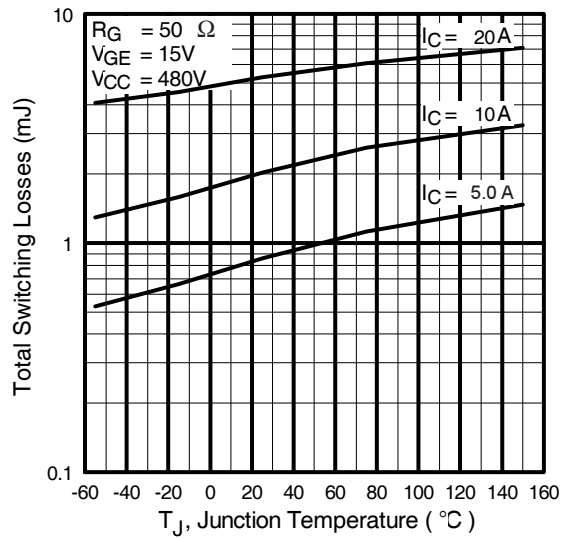

Fig. 10 - Typical Switching Losses vs. Junction Temperature

IRG4BC20SPbF

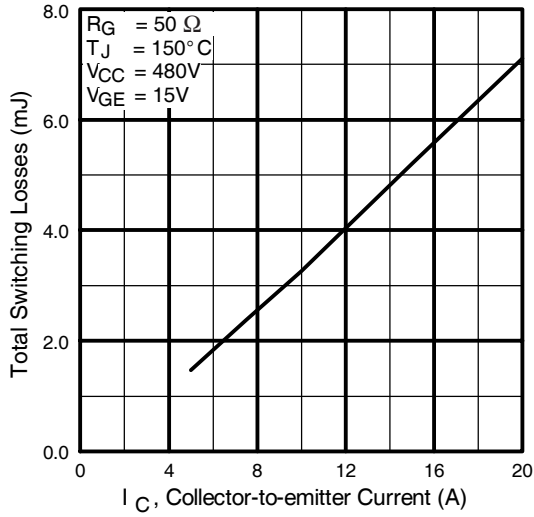

Fig. 11 - Typical Switching Losses vs. Collector-to-Emitter Current

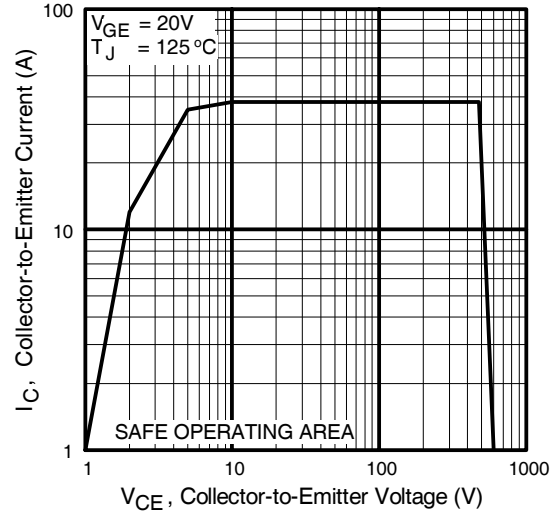

Fig. 12 - Turn-Off SOA

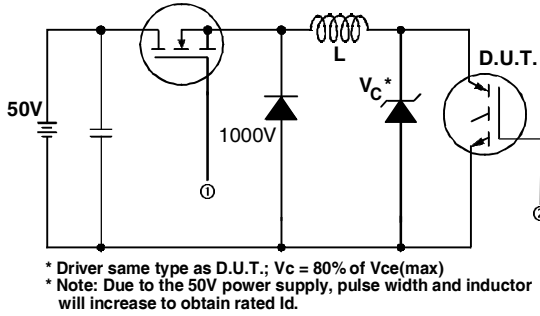
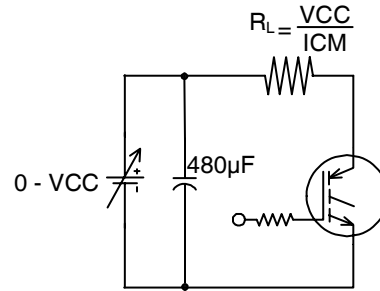

Fig. 13a - Clamped Inductive Load Test Circuit



Pulsed Collector Current Test Circuit

Fig. 13b - Pulsed Collector Current Test Circuit



Fig. 14a - Switching Loss Test Circuit

* Driver same type as D.U.T., $V_C = 480V$

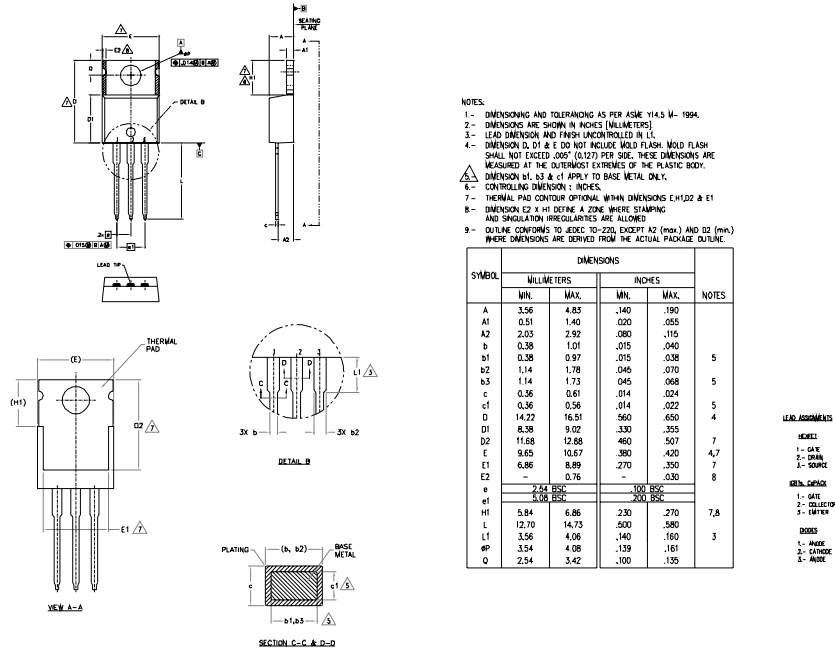

Fig. 14b - Switching Loss Waveforms

IRG4BC20SPbF



TO-220AB Package Outline (Dimensions are shown in millimeters (inches))



TO-220AB Part Marking Information

EXAMPLE: THIS IS AN IRF1010
 LOT CODE 1789
 ASSEMBLED ON WW 19, 1997
 IN THE ASSEMBLY LINE 'C'

Note: "P" in assembly line position indicates "Lead-Free"

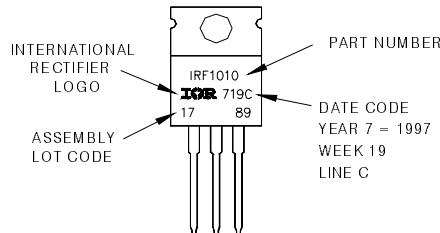

Note: For the most current drawing please refer to IR website at <http://www.irf.com/package/>

Data and specifications subject to change without notice.



IR WORLD HEADQUARTERS: 233 Kansas St., El Segundo, California 90245, USA Tel: (310) 252-7105
 TAC Fax: (310) 252-7903

Visit us at www.irf.com for sales contact information. 01/2010

www.irf.com

Данный компонент на территории Российской Федерации

Вы можете приобрести в компании MosChip.

Для оперативного оформления запроса Вам необходимо перейти по данной ссылке:

<http://moschip.ru/get-element>

Вы можете разместить у нас заказ для любого Вашего проекта, будь то серийное производство или разработка единичного прибора.

В нашем ассортименте представлены ведущие мировые производители активных и пассивных электронных компонентов.

Нашей специализацией является поставка электронной компонентной базы двойного назначения, продукции таких производителей как XILINX, Intel (ex.ALTERA), Vicor, Microchip, Texas Instruments, Analog Devices, Mini-Circuits, Amphenol, Glenair.

Сотрудничество с глобальными дистрибьюторами электронных компонентов, предоставляет возможность заказывать и получать с международных складов практически любой перечень компонентов в оптимальные для Вас сроки.

На всех этапах разработки и производства наши партнеры могут получить квалифицированную поддержку опытных инженеров.

Система менеджмента качества компании отвечает требованиям в соответствии с ГОСТ Р ИСО 9001, ГОСТ РВ 0015-002 и ЭС РД 009

Офис по работе с юридическими лицами:

105318, г.Москва, ул.Щербаковская д.3, офис 1107, 1118, ДЦ «Щербаковский»

Телефон: +7 495 668-12-70 (многоканальный)

Факс: +7 495 668-12-70 (доб.304)

E-mail: info@moschip.ru

Skype отдела продаж:

moschip.ru

moschip.ru_4

moschip.ru_6

moschip.ru_9