

Thyristor Modules

Thyristor/Diode Modules

$$I_{TRMS} = 2x 450 A$$

$$I_{TAVM} = 2x 250 A$$

$$V_{RRM} = 1200-1800 V$$

V_{RSM}	V_{RRM}	Type	
V_{DSM}	V_{DRM}		
V	V		
1300	1200	MCC 255-12io1	MCD 255-12io1
1500	1400	MCC 255-14io1	MCD 255-14io1
1700	1600	MCC 255-16io1	MCD 255-16io1
1900	1800	MCC 255-18io1	MCD 255-18io1



Symbol	Conditions	Maximum Ratings	
I_{TRMS}, I_{FRMS}	$T_{VJ} = T_{VJM}$	450	A
I_{TAVM}, I_{FAVM}	$T_C = 85^\circ C; 180^\circ$ sine	250	A
I_{TSM}, I_{FSM}	$T_{VJ} = 45^\circ C; t = 10$ ms (50 Hz)	9000	A
	$V_R = 0; t = 8.3$ ms (60 Hz)	9600	A
I^2t	$T_{VJ} = T_{VJM}; t = 10$ ms (50 Hz)	7800	A
	$V_R = 0; t = 8.3$ ms (60 Hz)	8600	A
$(di/dt)_{cr}$	$T_{VJ} = T_{VJM};$ repetitive, $I_T = 860$ A	100	A/ μ s
	$f = 50$ Hz; $t_p = 200$ μ s;		
	$V_D = 2/3 V_{DRM}; I_G = 1$ A; non repetitive, $I_T = I_{TAVM}$	500	A/ μ s
$(dv/dt)_{cr}$	$T_{VJ} = T_{VJM}; V_D = 2/3 V_{DRM}; R_{GK} = \infty;$ method 1 (linear voltage rise)	1000	V/ μ s
P_{GM}	$T_{VJ} = T_{VJM}; t_p = 30$ μ s	120	W
P_{GAV}	$I_T = I_{T(AV)M}; t_p = 500$ μ s	60	W
		20	W
V_{RGM}		10	V
T_{VJ}		-40...+130	$^\circ C$
T_{VJM}		130	$^\circ C$
T_{stg}		-40...+125	$^\circ C$
V_{ISOL}	50/60 Hz, RMS $t = 1$ min	3000	V~
	$I_{ISOL} \leq 1$ mA $t = 1$ s	3600	V~
M_d	Mounting torque (M6)	4.5 - 7	Nm
	Terminal connection torque (M8)	11 - 13	Nm
Weight	Typical including screws	750	g

Data according to IEC 60747 and refer to a single diode unless otherwise stated.

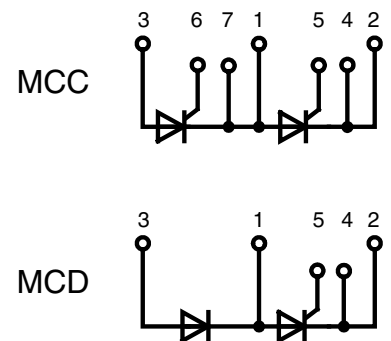

Features

- International standard package
- **D**irect **C**opper **B**onded Al_2O_3 -ceramic with copper base plate
- Planar passivated chips
- Isolation voltage 3600 V~
- UL registered, E 72873
- Keyed gate/cathode twin pins

Applications

- Motor control, softstarter
- Power converter
- Heat and temperature control for industrial furnaces and chemical processes
- Lighting control
- Solid state switches

Advantages

- Simple mounting
- Improved temperature and power cycling
- Reduced protection circuits

Symbol	Conditions	Characteristic Values	
		typ.	max.
I_{RRM}, I_{DRM}	$V_R / V_D = V_{RRM} / V_{DRM}$	$T_{VJ} = T_{VJM}$	40 mA
V_T, V_F	$I_T, I_F = 600 \text{ A}$	$T_{VJ} = 25^\circ\text{C}$	1.36 V
V_{T0}	For power-loss calculations only		0.8 V
r_t		$T_{VJ} = T_{VJM}$	0.68 mΩ
V_{GT}	$V_D = 6 \text{ V}$	$T_{VJ} = 25^\circ\text{C}$	2 V
		$T_{VJ} = -40^\circ\text{C}$	3 V
I_{GT}	$V_D = 6 \text{ V}$	$T_{VJ} = 25^\circ\text{C}$	150 mA
		$T_{VJ} = -40^\circ\text{C}$	220 mA
V_{GD}	$V_D = 2/3 V_{DRM}$	$T_{VJ} = T_{VJM}$	0.25 V
I_{GD}			10 mA
I_L	$t_p = 30 \mu\text{s}; V_D = 6 \text{ V}$ $I_G = 0.45 \text{ A}; di_G/dt = 0.45 \text{ A}/\mu\text{s}$	$T_{VJ} = 25^\circ\text{C}$	200 mA
I_H	$V_D = 6 \text{ V}; R_{GK} = \infty;$	$T_{VJ} = 25^\circ\text{C}$	150 mA
t_{gd}	$V_D = 1/2 V_{DRM}$ $I_G = 1 \text{ A}; di_G/dt = 1 \text{ A}/\mu\text{s}$	$T_{VJ} = 25^\circ\text{C}$	2 μs
t_q	$V_D = 2/3 V_{DRM}$ $dv/dt = 50 \text{ V}/\mu\text{s}; -di/dt = 10 \text{ A}/\mu\text{s}$ $I_T = 300 \text{ A}; V_R = 100 \text{ V}; t_p = 200 \mu\text{s}$	$T_{VJ} = T_{VJM}$	200 μs
Q_S	$I_T = 300 \text{ A}; -di/dt = 50 \text{ A}/\mu\text{s}$	$T_{VJ} = T_{VJM}$	760 μC
I_{RM}			275 A
R_{thJC}	per thyristor; DC current per module		0.139 K/W 0.07 K/W
R_{thJK}	per thyristor; DC current per module		0.179 K/W 0.09 K/W
d_S	Creeping distance on surface		12.7 mm
d_A	Creepage distance in air		9.6 mm
a	Maximum allowable acceleration		50 m/s ²

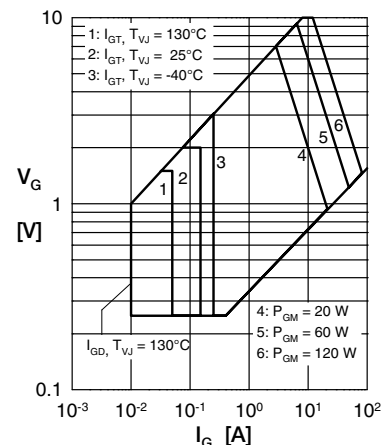

Fig. 3 Surge overload current
 $I_{TSM/FSM}$: Crest value, t: duration

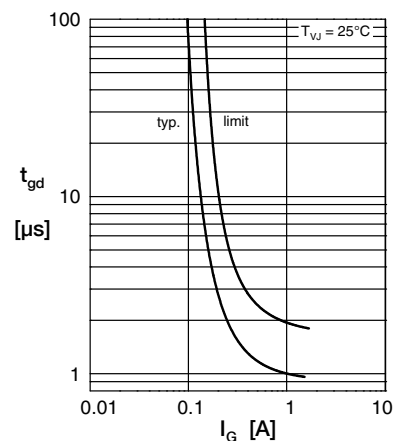
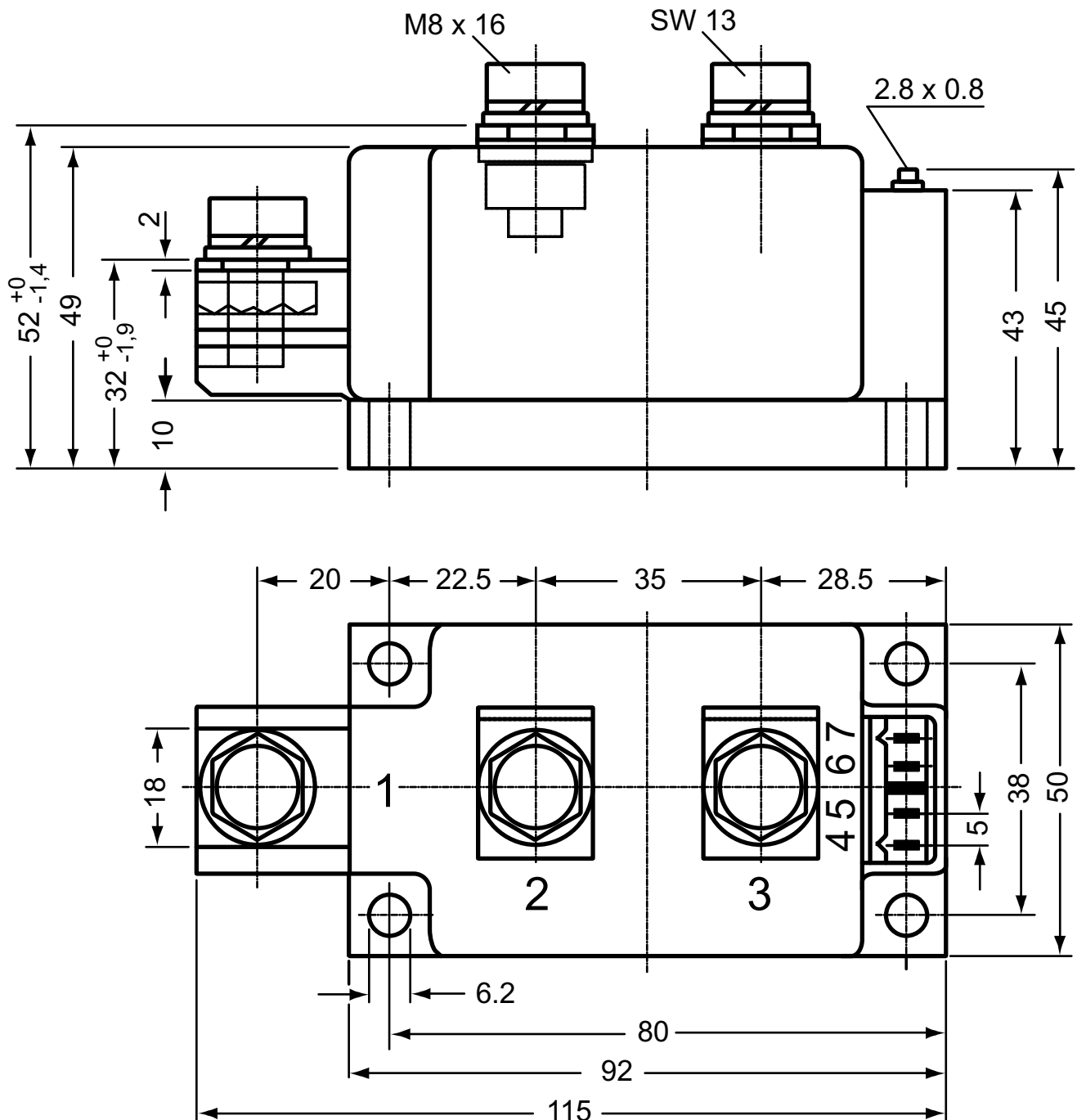

Fig. 2 Gate trigger delay time

Dimensions in mm (1 mm = 0.0394")



Optional accessories for modules

Keyed gate/cathode twin plugs with wire length = 350 mm, gate = white, cathode = red

Type ZY 180L (L = Left for pin pair 4/5)

Type ZY 180R (R = Right for pin pair 6/7) } UL 758, style 3751

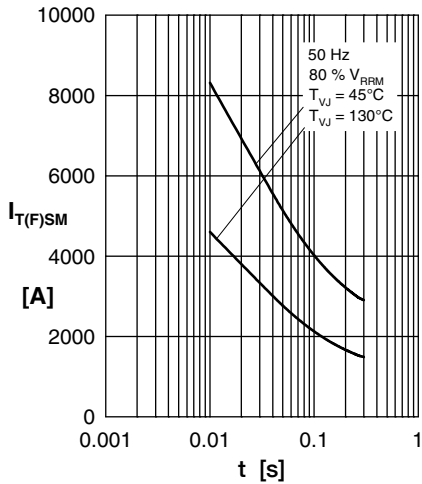

Fig. 3 Surge overload current
 $I_{T(F)SM}$: Crest value, t: duration

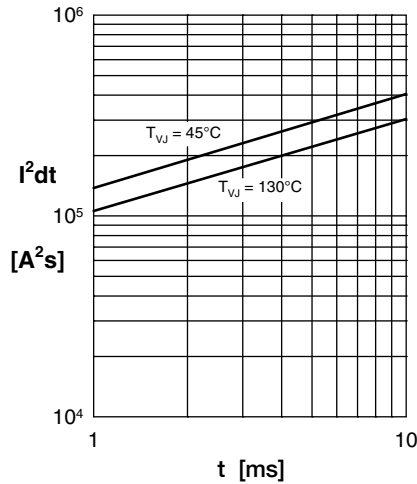

Fig. 4 I^2dt versus time

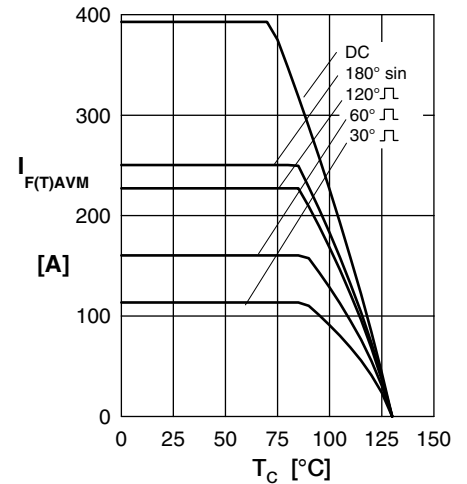

Fig. 4a Max. forward current at case temperature

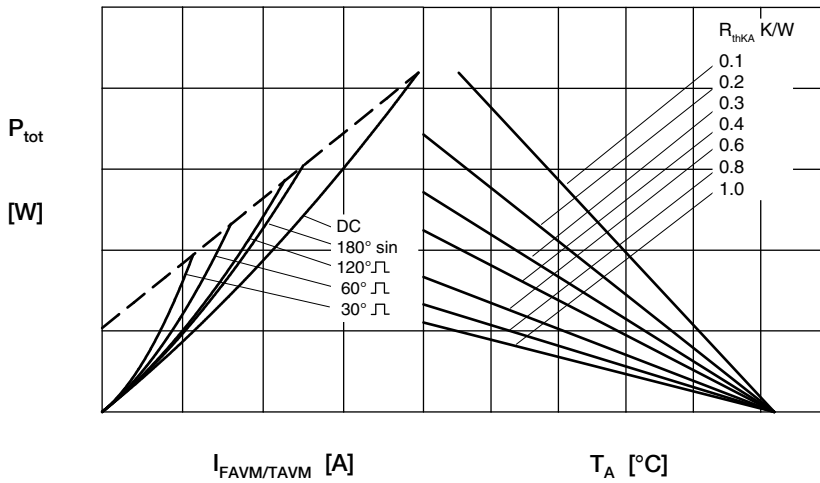

Fig. 5 Power dissipation versus on-state current and ambient temperature (per thyristor or diode)

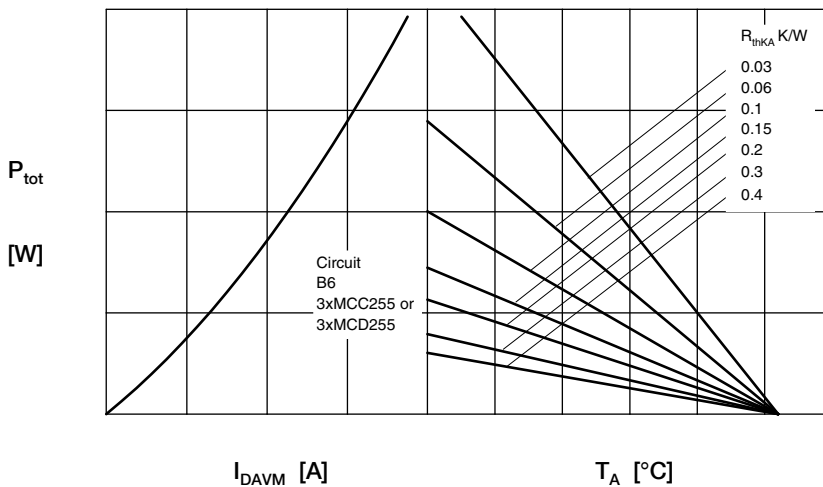

Fig. 6 Three phase rectifier bridge: Power dissipation versus direct output current and ambient temperature



Fig. 7 Three phase AC-controller: Power dissipation versus I_{RMS} output current and ambient temperature

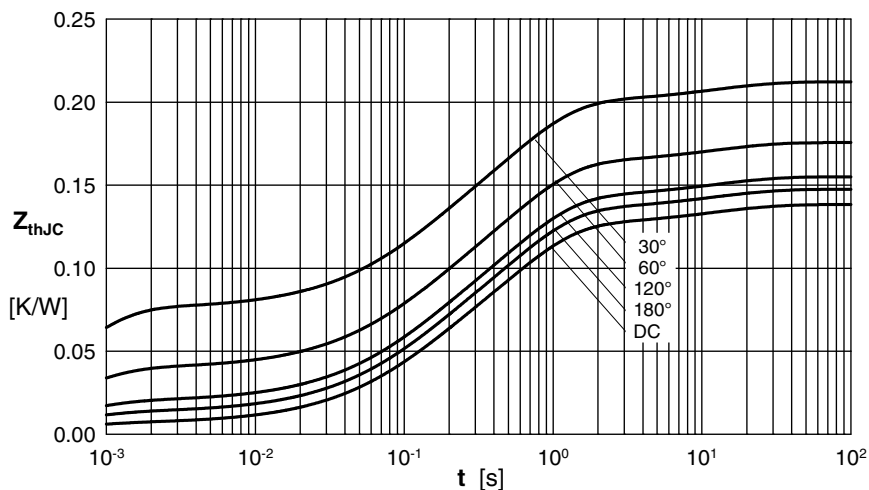

Fig. 8 Transient thermal impedance junction to case (per thyristor/diode)

R_{thJC} for various conduct. angles d:

d	R_{thJC} (K/W)
DC	0.139
180°	0.148
120°	0.156
60°	0.176
30°	0.214

Constants for Z_{thJC} calculation:

i	R_{thi} (K/W)	t_i (s)
1	0.0066	0.00054
2	0.0358	0.098
3	0.0831	0.54
4	0.0129	12

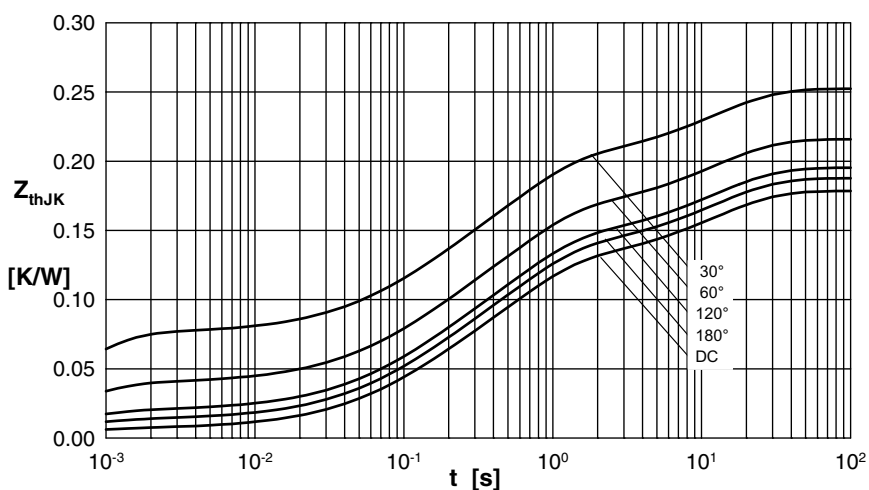

Fig. 9 Transient thermal impedance junction to heatsink (per thyristor/diode)

R_{thJK} for various conduct. angles d:

d	R_{thJK} (K/W)
DC	0.179
180°	0.188
120°	0.196
60°	0.216
30°	0.254

Constants for Z_{thJK} calculation:

i	R_{thi} (K/W)	t_i (s)
1	0.0066	0.00054
2	0.0358	0.098
3	0.0831	0.54
4	0.0129	12
5	0.04	12

Данный компонент на территории Российской Федерации

Вы можете приобрести в компании MosChip.

Для оперативного оформления запроса Вам необходимо перейти по данной ссылке:

<http://moschip.ru/get-element>

Вы можете разместить у нас заказ для любого Вашего проекта, будь то серийное производство или разработка единичного прибора.

В нашем ассортименте представлены ведущие мировые производители активных и пассивных электронных компонентов.

Нашей специализацией является поставка электронной компонентной базы двойного назначения, продукции таких производителей как XILINX, Intel (ex.ALTERA), Vicor, Microchip, Texas Instruments, Analog Devices, Mini-Circuits, Amphenol, Glenair.

Сотрудничество с глобальными дистрибьюторами электронных компонентов, предоставляет возможность заказывать и получать с международных складов практически любой перечень компонентов в оптимальные для Вас сроки.

На всех этапах разработки и производства наши партнеры могут получить квалифицированную поддержку опытных инженеров.

Система менеджмента качества компании отвечает требованиям в соответствии с ГОСТ Р ИСО 9001, ГОСТ РВ 0015-002 и ЭС РД 009

Офис по работе с юридическими лицами:

105318, г.Москва, ул.Щербаковская д.3, офис 1107, 1118, ДЦ «Щербаковский»

Телефон: +7 495 668-12-70 (многоканальный)

Факс: +7 495 668-12-70 (доб.304)

E-mail: info@moschip.ru

Skype отдела продаж:

moschip.ru

moschip.ru_4

moschip.ru_6

moschip.ru_9