

Low drop power Schottky rectifier

Datasheet - production data

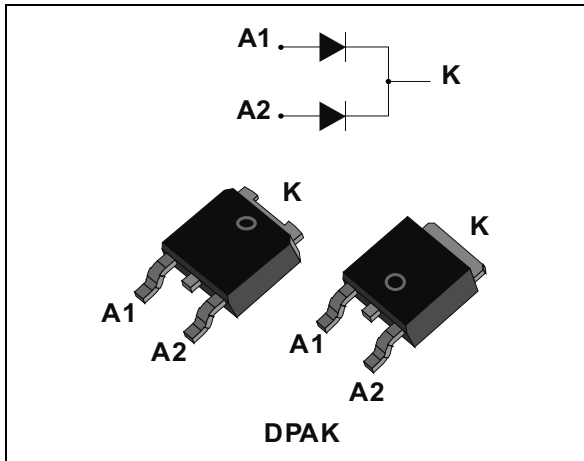

Description

Dual center tab Schottky rectifier suited for switched mode power supply and high frequency DC to DC converters.

Packaged in DPAK, this device is intended for use in low voltage, high frequency inverters, free-wheeling and polarity protection applications.

Table 1. Device summary

Symbol	Value
$I_{F(AV)}$	2 x 7.5 A
V_{RRM}	30 V
T_j	150 °C
V_F (typ)	0.34 V

Features

- Very small conduction losses
- Negligible switching losses
- Extremely fast switching
- Low forward voltage drop
- Low capacitance
- Low thermal resistance
- Avalanche specification
- ECOPACK[®]2 compliant component for DPAK on demand

1 Characteristics

Table 2. Absolute ratings (limiting values per diode at 25 °C unless otherwise stated)

Symbol	Parameter		Value	Unit
V_{RRM}	Repetitive peak reverse voltage		30	V
$I_{F(RMS)}$	Forward rms current		10	A
$I_{F(AV)}$	Average forward current, $\delta = 0.5$, square wave	$T_c = 140\text{ °C}^{(1)}$ Per diode	7.5	A
		Per device	15	
I_{FSM}	Surge non repetitive forward current	$t_p = 10\text{ ms sinusoidal}$	75	A
P_{ARM}	Repetitive peak avalanche power	$t_p = 10\text{ }\mu\text{s}, T_j = 125\text{ °C}$	200	W
T_{stg}	Storage temperature range		-65 to +175	°C
T_j	Maximum operating junction temperature ⁽²⁾		150	°C

- Value based on $R_{th(j-c)}$ max (per diode)
- $\frac{dP_{tot}}{dT_j} < \frac{1}{R_{th(j-a)}}$ condition to avoid thermal runaway for a diode on its own heatsink

Table 3. Thermal resistances

Symbol	Parameter		Value	Unit
$R_{th(j-c)}$	Junction to case	Per diode	4	°C/W
		Total	2.4	
$R_{th(c)}$	Coupling		0.7	

When the diodes 1 and 2 are used simultaneously:

$$\Delta T_j(\text{diode } 1) = P(\text{diode } 1) \times R_{th(j-c)}(\text{Per diode}) + P(\text{diode } 2) \times R_{th(c)}$$

Table 4. Static electrical characteristics (per diode)

Symbol	Parameter	Test Conditions		Min.	Typ.	Max.	Unit
$I_R^{(1)}$	Reverse leakage current	$T_j = 25\text{ °C}$	$V_R = V_{RRM}$			1	mA
		$T_j = 125\text{ °C}$			70	140	mA
$V_F^{(2)}$	Forward voltage drop	$T_j = 25\text{ °C}$	$I_F = 7.5\text{ A}$			0.48	V
		$T_j = 125\text{ °C}$	$I_F = 7.5\text{ A}$		0.34	0.39	
		$T_j = 25\text{ °C}$	$I_F = 12\text{ A}$			0.53	
		$T_j = 125\text{ °C}$	$I_F = 12\text{ A}$		0.40	0.47	
		$T_j = 25\text{ °C}$	$I_F = 15\text{ A}$			0.57	
		$T_j = 125\text{ °C}$	$I_F = 15\text{ A}$		0.44	0.51	

- Pulse test: $t_p = 5\text{ ms}, \delta < 2\%$
- Pulse test: $t_p = 380\text{ }\mu\text{s}, \delta < 2\%$

To evaluate the conduction losses use the following equation:

$$P = 0.27 \times I_{F(AV)} + 0.016 I_{F(RMS)}^2$$

Figure 1. Average forward power dissipation versus average forward current (per diode)

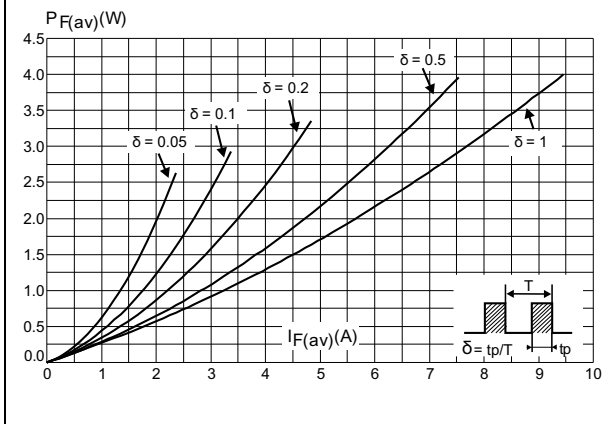

Figure 2. Average forward current versus ambient temperature ($\delta = 0.5$)(per diode)

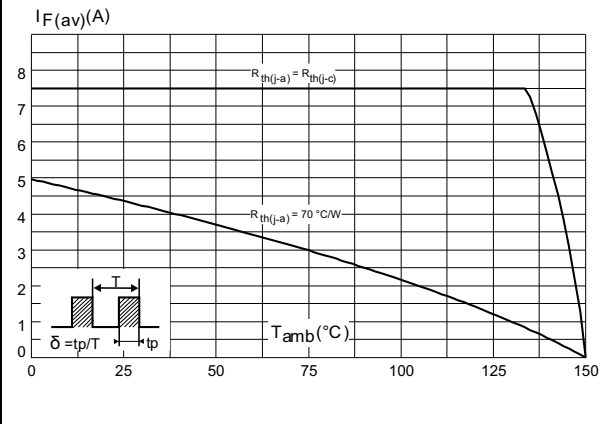

Figure 3. Normalized avalanche power derating versus pulse duration at $T_j = 125$ °C

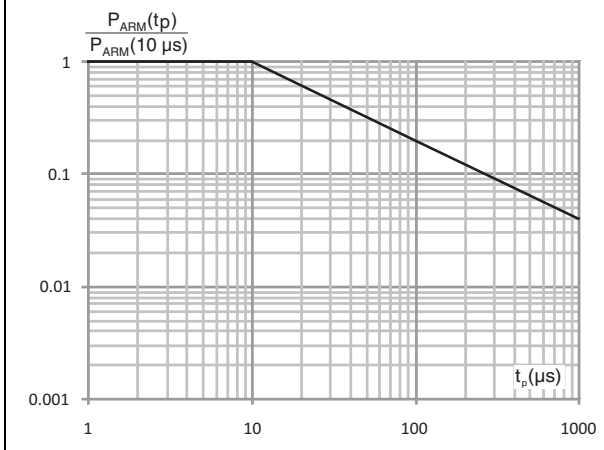

Figure 4. Relative variation of thermal impedance junction to case versus pulse duration

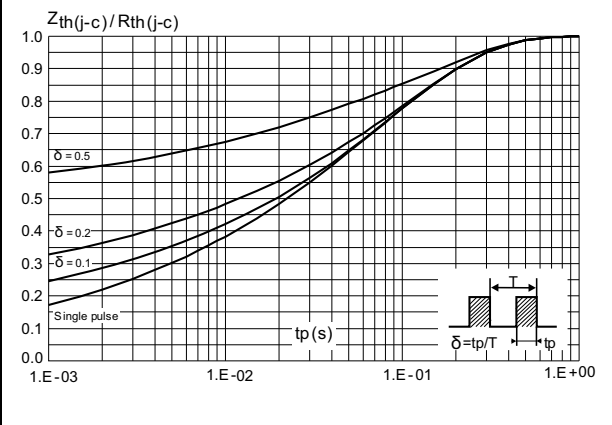

Figure 5. Reverse leakage current versus reverse voltage applied (typical values, per diode)

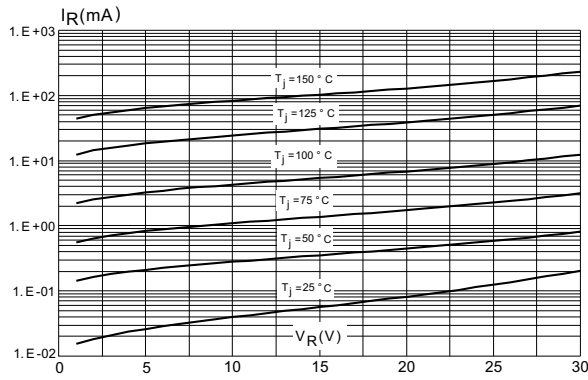

Figure 6. Junction capacitance versus reverse voltage applied (typical values, per diode)

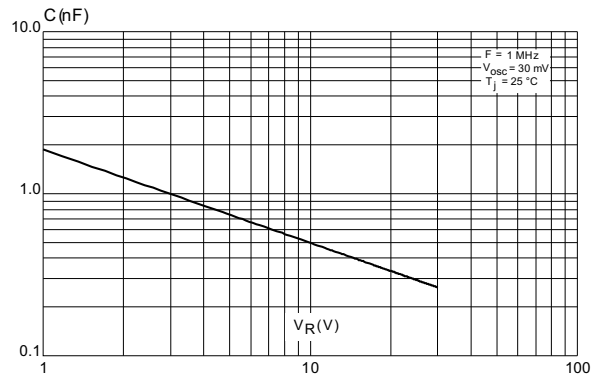

Figure 7. Forward voltage drop versus forward current (per diode)

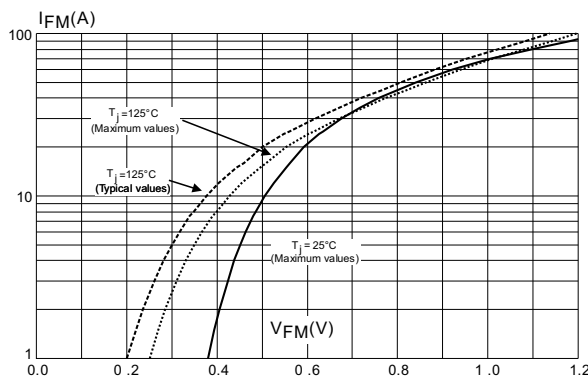
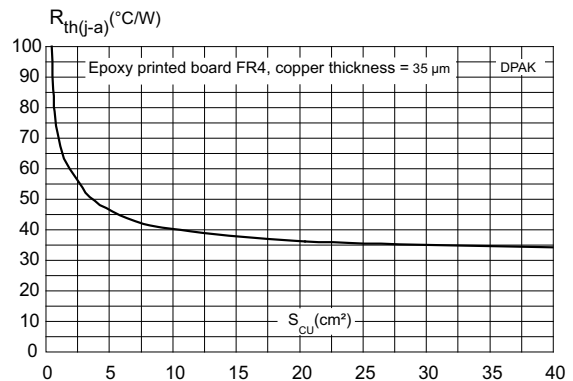

Figure 8. Thermal resistance junction to ambient versus copper surface under tab



2 Package Information

- Epoxy meets UL94,V0
- Cooling method: by conduction (C)

In order to meet environmental requirements, ST offers these devices in different grades of ECOPACK® packages, depending on their level of environmental compliance. ECOPACK® specifications, grade definitions and product status are available at: www.st.com. ECOPACK® is an ST trademark.

2.1 DPAK package information

Figure 9. DPAK package outline

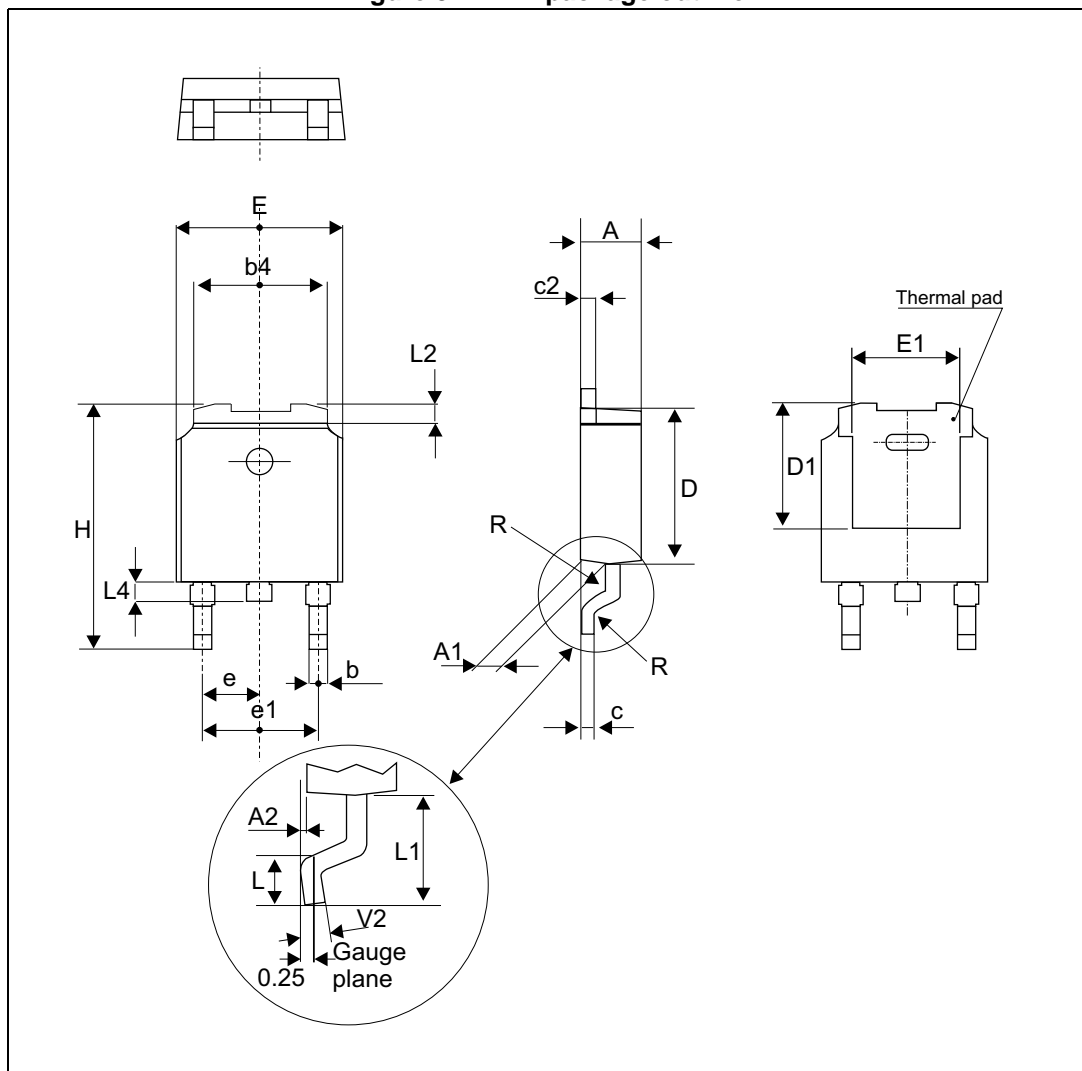

Note: This package drawing may slightly differ from the physical package. However, all the specified dimensions are guaranteed.

Table 5. DPAK package mechanical data

Ref.	Dimensions					
	Millimeters			Inches		
	Min.	Typ.	Max.	Min.	Typ.	Max.
A	2.18		2.40	0.085		0.094
A1	0.90		1.10	0.035		0.043
A2	0.03		0.23	0.001		0.009
b	0.64		0.90	0.025		0.035
b4	4.95		5.46	0.194		0.214
c	0.46		0.61	0.018		0.024
c2	0.46		0.60	0.018		0.023
D	5.97		6.22	0.235		0.244
D1	4.95		5.60	0.194		0.220
E	6.35		6.73	0.250		0.264
E1	4.32		5.50	0.170		0.216
e		2.28			0.090	
e1	4.40		4.70	0.173		0.185
H	9.35		10.40	0.368		0.409
L	1.00		1.78	0.039		0.070
L2			1.27			0.050
L4	0.60		1.02	0.023		0.040
V2	-8°		+8°	-8°		8°

Figure 10. DPAK footprint dimensions (in mm)

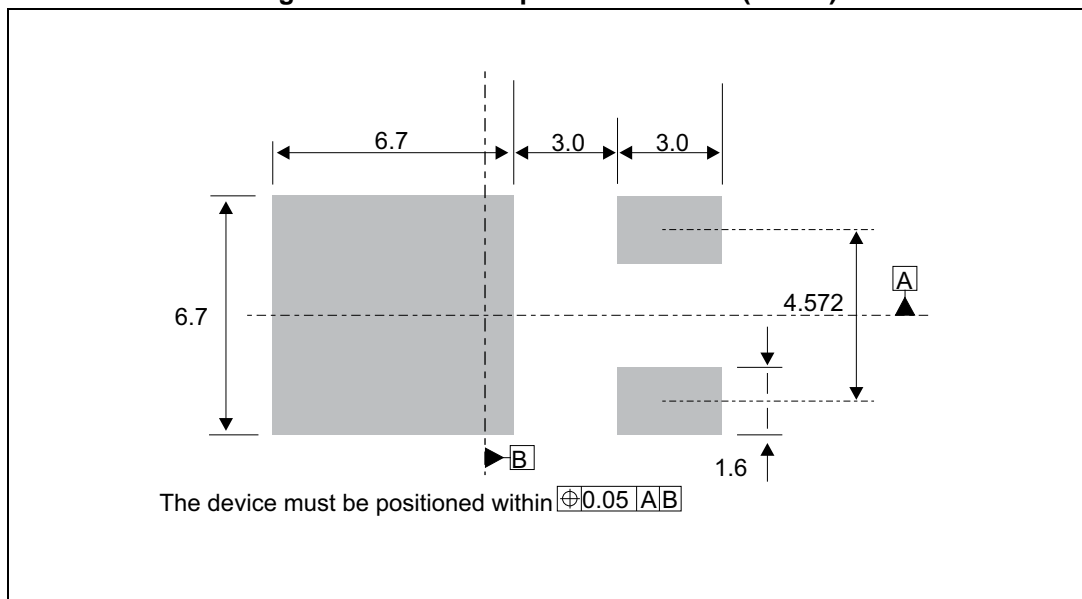

3 Ordering Information

Table 6. Ordering information

Order code	Marking	Package	Weight	Base qty	Delivery mode
STPS15L30CB	S15L30C	DPAK	0.30 g	75	Tube
STPS15L30CB-TR	S15L30C	DPAK	0.30 g	2500	Tape and reel

4 Revision history

Table 7. Document revision history

Date	Revision	Description of Changes
14-Jun-2012	2	Automatic revalidation date workflow started.
21-Oct-2014	3	Updated DPAK package information and reformatted to current standard. Removed IPAK.
18-Dec-2015	4	Updated DPAK package information and reformatted to current standard.

IMPORTANT NOTICE – PLEASE READ CAREFULLY

STMicroelectronics NV and its subsidiaries ("ST") reserve the right to make changes, corrections, enhancements, modifications, and improvements to ST products and/or to this document at any time without notice. Purchasers should obtain the latest relevant information on ST products before placing orders. ST products are sold pursuant to ST's terms and conditions of sale in place at the time of order acknowledgement.

Purchasers are solely responsible for the choice, selection, and use of ST products and ST assumes no liability for application assistance or the design of Purchasers' products.

No license, express or implied, to any intellectual property right is granted by ST herein.

Resale of ST products with provisions different from the information set forth herein shall void any warranty granted by ST for such product.

ST and the ST logo are trademarks of ST. All other product or service names are the property of their respective owners.

Information in this document supersedes and replaces information previously supplied in any prior versions of this document.

© 2015 STMicroelectronics – All rights reserved

Данный компонент на территории Российской Федерации

Вы можете приобрести в компании MosChip.

Для оперативного оформления запроса Вам необходимо перейти по данной ссылке:

<http://moschip.ru/get-element>

Вы можете разместить у нас заказ для любого Вашего проекта, будь то серийное производство или разработка единичного прибора.

В нашем ассортименте представлены ведущие мировые производители активных и пассивных электронных компонентов.

Нашей специализацией является поставка электронной компонентной базы двойного назначения, продукции таких производителей как XILINX, Intel (ex.ALTERA), Vicor, Microchip, Texas Instruments, Analog Devices, Mini-Circuits, Amphenol, Glenair.

Сотрудничество с глобальными дистрибьюторами электронных компонентов, предоставляет возможность заказывать и получать с международных складов практически любой перечень компонентов в оптимальные для Вас сроки.

На всех этапах разработки и производства наши партнеры могут получить квалифицированную поддержку опытных инженеров.

Система менеджмента качества компании отвечает требованиям в соответствии с ГОСТ Р ИСО 9001, ГОСТ РВ 0015-002 и ЭС РД 009

Офис по работе с юридическими лицами:

105318, г.Москва, ул.Щербаковская д.3, офис 1107, 1118, ДЦ «Щербаковский»

Телефон: +7 495 668-12-70 (многоканальный)

Факс: +7 495 668-12-70 (доб.304)

E-mail: info@moschip.ru

Skype отдела продаж:

moschip.ru

moschip.ru_4

moschip.ru_6

moschip.ru_9