

THIS DRAWING IS UNPUBLISHED. RELEASED FOR PUBLICATION 20  
 © COPYRIGHT 20 BY - ALL RIGHTS RESERVED.

LOC		DIST		REVISIONS			
GP	00	P	LTR	DESCRIPTION	DATE	DWN	APVD
		B		REVISED PER ECO-11-006746	04/APR/11	ECC	PJB
		C		REVISED PER ECR-11-013082	23/JUN/11	ECC	PJB
		E		ECR-12-019784	19NOV2012	TB	DM

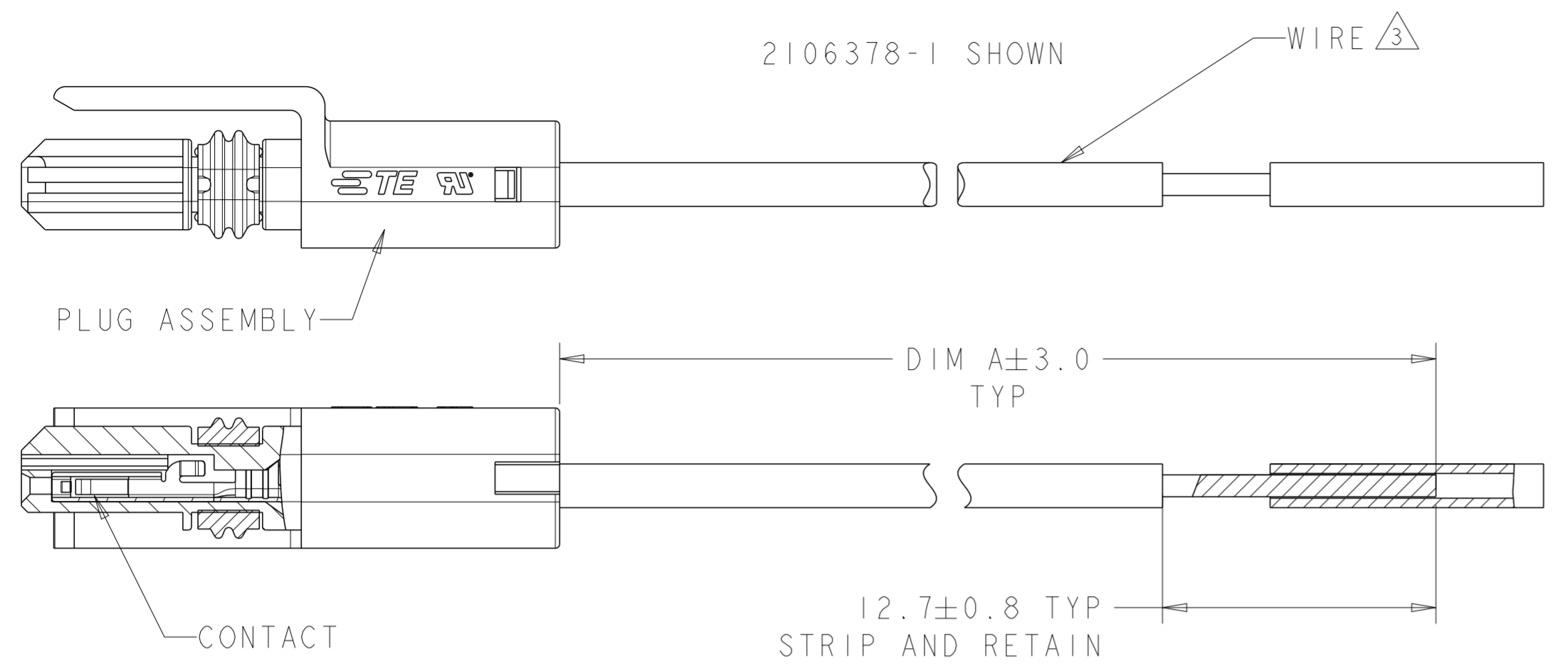

- ⚠ MATERIALS AND FINISH:  
 - CONTACTS: COPPER ALLOY  
 FINISH: TIN IN CONTACT AREA OVER NICKEL UNDERPLATE  
 - WIRE: 18 AWG, STRANDED, UL 1007 STYLE
- 2. MUST COMPLY WITH DIRECTIVE 2002/95/EC (ROHS)
- ⚠ REFERENCE CHART FOR SPECIFIC WIRE COLOR/POSITION.
- ⚠ CONTACTS 0.000381 THK GOLD STRIPE PRE-PLATED STOCK, REF.

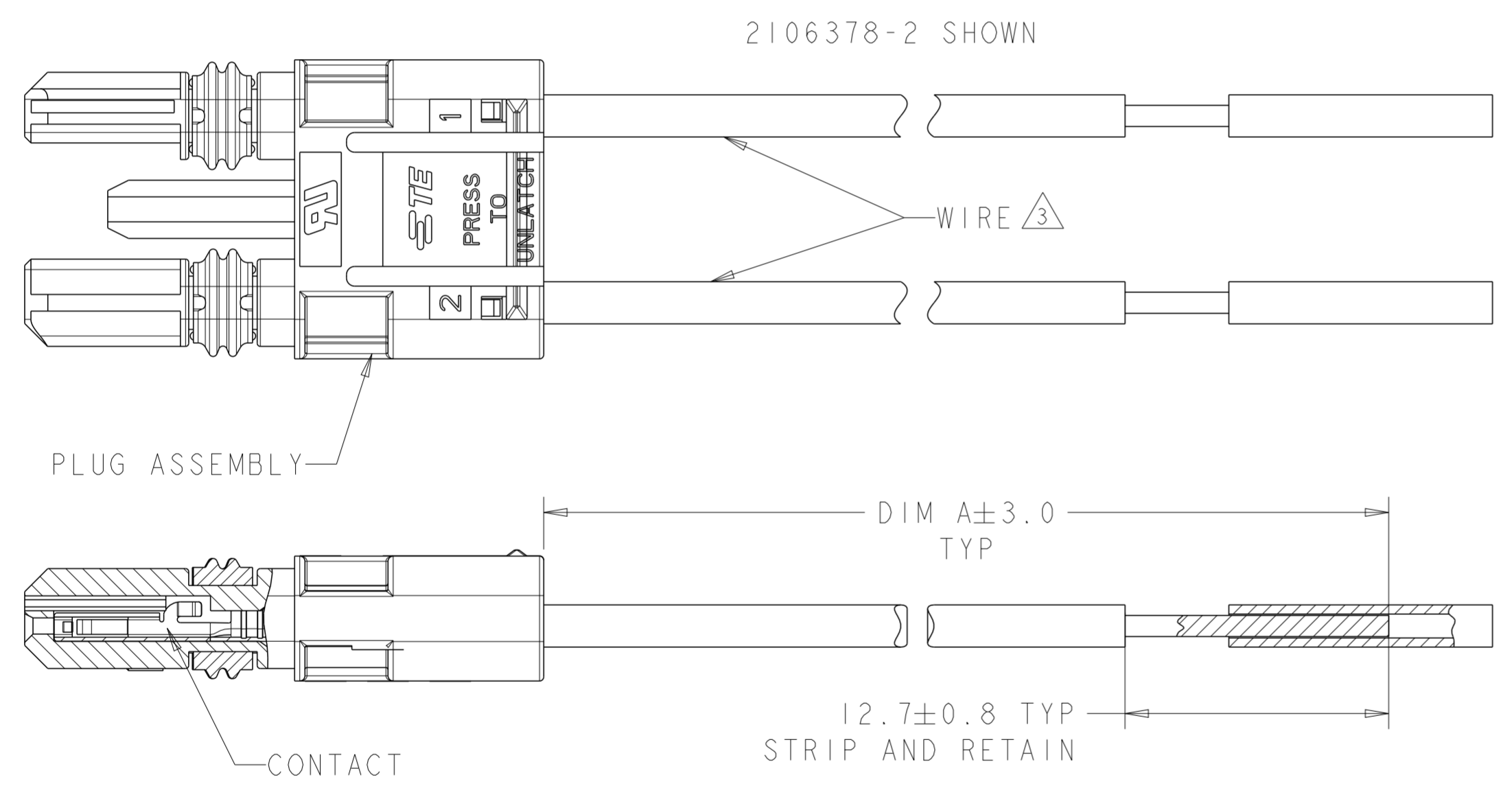

⚠	DIM A	WIRE SIZE	POSN	PART NO.
⚠	304.8	20 AWG	4	3-2106378-3
⚠	304.8	20 AWG	2	3-2106378-1
⚠	101.6	20 AWG	2	2-2106378-8
	381.0	18 AWG	2	2-2106378-6
	304.8	24 AWG	4	2-2106378-5
	304.8	24 AWG	3	2-2106378-4
	304.8	24 AWG	2	2-2106378-3
	101.6	24 AWG	4	2-2106378-2
	101.6	24 AWG	3	2-2106378-1
	101.6	24 AWG	2	2-2106378-0
	304.8	22 AWG	4	1-2106378-9
	304.8	22 AWG	3	1-2106378-8
	304.8	22 AWG	2	1-2106378-7
	101.6	22 AWG	4	1-2106378-6
	101.6	22 AWG	3	1-2106378-5
	101.6	22 AWG	2	1-2106378-4
	304.8	20 AWG	4	1-2106378-3
	304.8	20 AWG	3	1-2106378-2
	304.8	20 AWG	2	1-2106378-1
	101.6	20 AWG	4	1-2106378-0
	101.6	20 AWG	3	2106378-9
	101.6	20 AWG	2	2106378-8
	304.8	18 AWG	4	2106378-7
	304.8	18 AWG	3	2106378-6
	304.8	18 AWG	2	2106378-5
	101.6	18 AWG	4	2106378-4
	101.6	18 AWG	3	2106378-3
	101.6	18 AWG	2	2106378-2
	101.6	18 AWG	1	2106378-1

WIRE COLOR CHART

4	-	-	-	BLUE	-	-	BLUE	-	-	BLUE	-	-	BLUE	-	-	BLUE	-	-	BLUE	-	-	BLUE	-	-		
3	-	-	WHITE	WHITE	-	WHITE	WHITE	-	WHITE	WHITE	-	WHITE	WHITE	-	WHITE	WHITE	-	WHITE	WHITE	-	WHITE	WHITE	-	WHITE	WHITE	
2	-	RED	RED	RED	RED	RED	RED	RED	RED	RED	RED	RED	RED	RED	RED	RED	RED	RED	RED	RED	RED	RED	RED	RED	BLACK	
1	BLACK	BLACK	BLACK	BLACK	BLACK	BLACK	BLACK	BLACK	BLACK	BLACK	BLACK	BLACK	BLACK	BLACK	BLACK	BLACK	BLACK	BLACK	BLACK	BLACK	BLACK	BLACK	BLACK	BLACK	RED	
POS	-1	-2	-3	-4	-5	-6	-7	-8	-9	-10	-11	-12	-13	-14	-15	-16	-17	-18	-19	-20	-21	-22	-23	-24	-25	-26

4	-	-	-	-	-	-	BLUE
3	-	-	-	-	-	-	WHITE
2	-	RED	-	-	RED	-	RED
1	-	BLACK	-	-	BLACK	-	BLACK
POS	-27	-28	-29	-30	-31	-32	-33

THIS DRAWING IS A CONTROLLED DOCUMENT.

DIMENSIONS:	TOLERANCES UNLESS OTHERWISE SPECIFIED:	DWN R BROWN 16APR2009	TE Connectivity CABLE ASSEMBLY, PLUG, SLIMSEAL SSL CONNECTOR
mm	0 PLC ± 1 PLC ±0.2 2 PLC ± 3 PLC ± 4 PLC ± ANGLES ± FINISH	CHK M MOSTOLLER 16APR2009	
MATERIAL		APVD	NAME
		PRODUCT SPEC	
		APPLICATION SPEC	
		WEIGHT	SIZE CAGE CODE DRAWING NO RESTRICTED TO
		CUSTOMER DRAWING	A200779 C-2106378
		SCALE	SHEET 1 OF 3 REV E

THIS DRAWING IS UNPUBLISHED. RELEASED FOR PUBLICATION 20  
 © COPYRIGHT 20 BY - ALL RIGHTS RESERVED.

LOC	DIST	REVISIONS					
GP	00	P	LTR	DESCRIPTION	DATE	DWN	APVD
		-		SEE SHEET 1	-	-	-

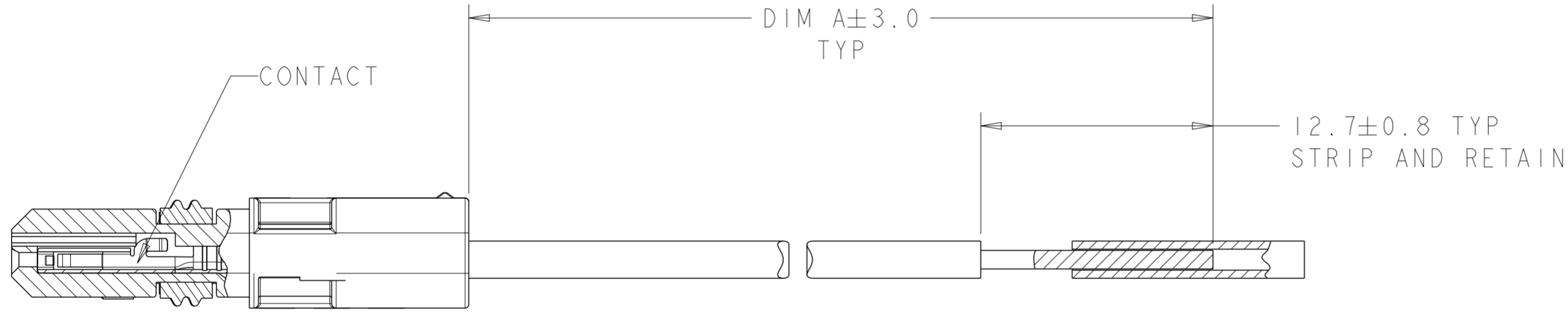
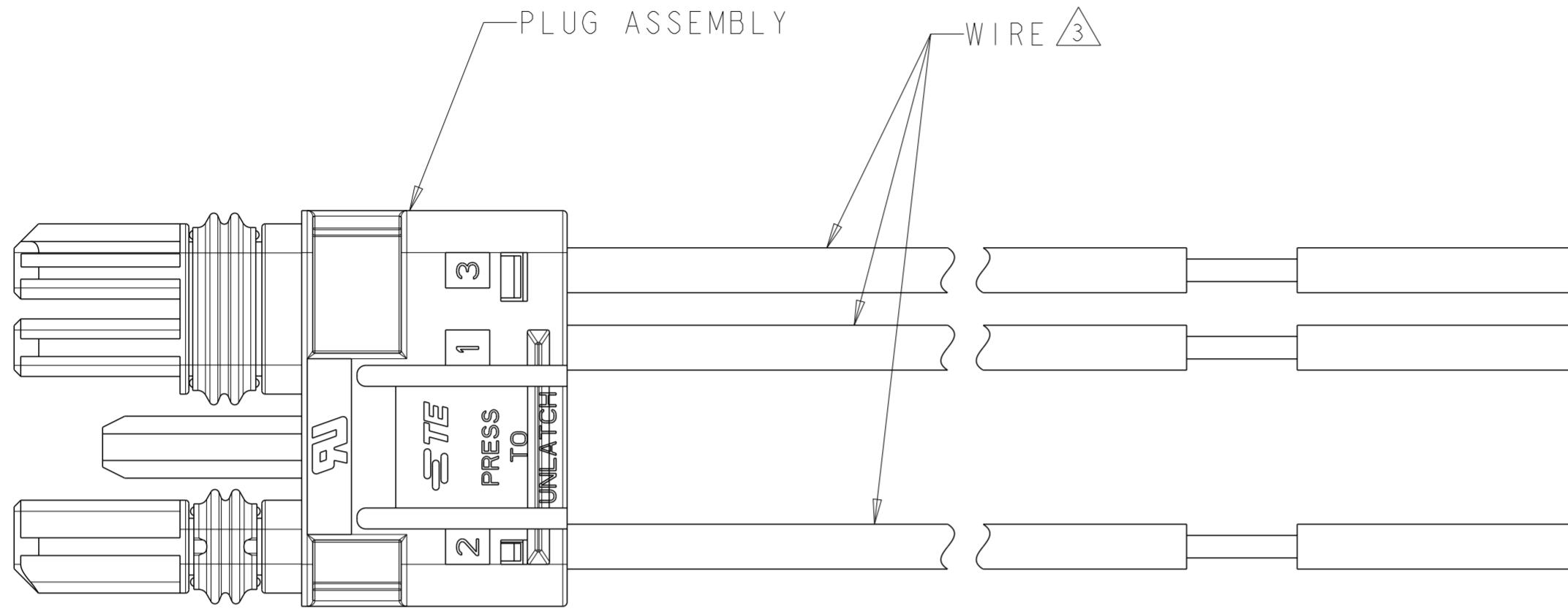

2106378-3 SHOWN

THIS DRAWING IS A CONTROLLED DOCUMENT.		DWN R BROWN 16APR2009	TE Connectivity		
DIMENSIONS: mm		CHK M MOSTOLLER 16APR2009			
TOLERANCES UNLESS OTHERWISE SPECIFIED:		APVD -	NAME CABLE ASSEMBLY, PLUG, SLIMSEAL SSL CONNECTOR		
0 PLC ±		PRODUCT SPEC -	SIZE A200779		
1 PLC ±0.2		APPLICATION SPEC -	CAGE CODE C-2106378		
2 PLC ±		WEIGHT -	DRAWING NO -		
3 PLC ±		CUSTOMER DRAWING	RESTRICTED TO -		
4 PLC ±		SCALE 1:1	SHEET 2 OF 3		
ANGLES ±			REV E		
FINISH					

THIS DRAWING IS UNPUBLISHED. RELEASED FOR PUBLICATION 20  
 © COPYRIGHT 20 BY - ALL RIGHTS RESERVED.

LOC	DIST	REVISIONS					
GP	00	P	LTR	DESCRIPTION	DATE	DWN	APVD
		-		SEE SHEET 1	-	-	-

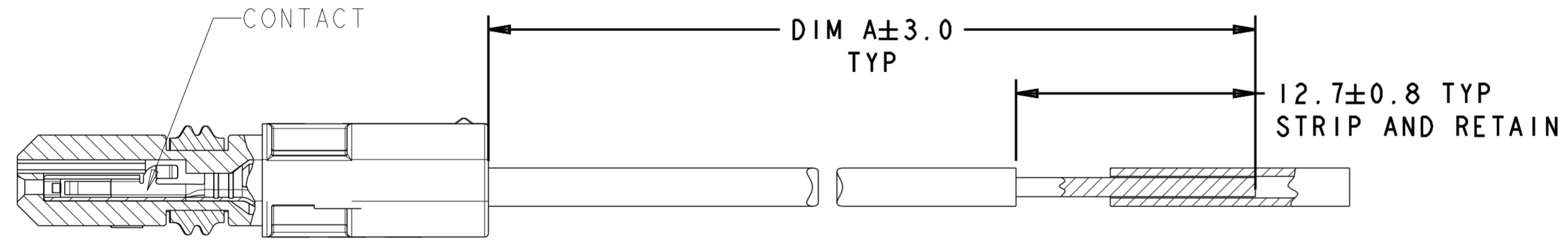
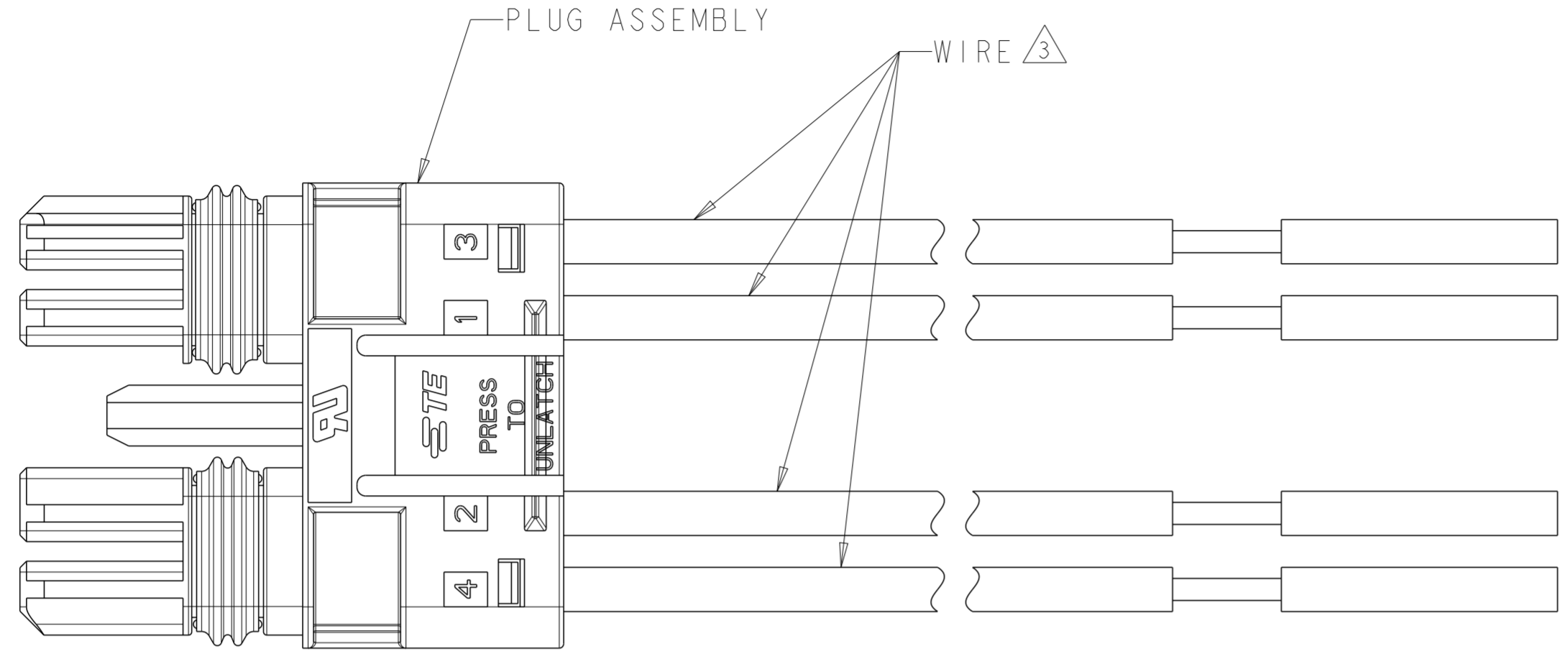

2106378-4 SHOWN

THIS DRAWING IS A CONTROLLED DOCUMENT.		DWN R BROWN 16APR2009	 TE Connectivity	
DIMENSIONS: mm		CHK M MOSTOLLER 16APR2009		
TOLERANCES UNLESS OTHERWISE SPECIFIED:		APVD -	NAME CABLE ASSEMBLY, PLUG, SLIMSEAL SSL CONNECTOR	
0 PLC ± 1 PLC ±0.2 2 PLC ± 3 PLC ± 4 PLC ± ANGLES ± FINISH		PRODUCT SPEC -	SIZE A200779	
MATERIAL -		APPLICATION SPEC -	DRAWING NO C-2106378	
		WEIGHT -	RESTRICTED TO -	
		CUSTOMER DRAWING	SCALE 1:1	SHEET 3 OF 3
			REV E	

## Данный компонент на территории Российской Федерации

### Вы можете приобрести в компании MosChip.

Для оперативного оформления запроса Вам необходимо перейти по данной ссылке:

<http://moschip.ru/get-element>

Вы можете разместить у нас заказ для любого Вашего проекта, будь то серийное производство или разработка единичного прибора.

В нашем ассортименте представлены ведущие мировые производители активных и пассивных электронных компонентов.

Нашей специализацией является поставка электронной компонентной базы двойного назначения, продукции таких производителей как XILINX, Intel (ex.ALTERA), Vicor, Microchip, Texas Instruments, Analog Devices, Mini-Circuits, Amphenol, Glenair.

Сотрудничество с глобальными дистрибьюторами электронных компонентов, предоставляет возможность заказывать и получать с международных складов практически любой перечень компонентов в оптимальные для Вас сроки.

На всех этапах разработки и производства наши партнеры могут получить квалифицированную поддержку опытных инженеров.

Система менеджмента качества компании отвечает требованиям в соответствии с ГОСТ Р ИСО 9001, ГОСТ РВ 0015-002 и ЭС РД 009

### Офис по работе с юридическими лицами:

105318, г.Москва, ул.Щербаковская д.3, офис 1107, 1118, ДЦ «Щербаковский»

Телефон: +7 495 668-12-70 (многоканальный)

Факс: +7 495 668-12-70 (доб.304)

E-mail: [info@moschip.ru](mailto:info@moschip.ru)

Skype отдела продаж:

moschip.ru

moschip.ru\_4

moschip.ru\_6

moschip.ru\_9