

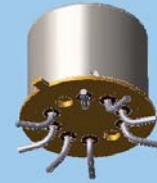

**SURFACE MOUNT  
HIGH REPEATABILITY,  
BROADBAND TO-5 RELAYS  
DPDT**



| SERIES   | RELAY TYPE   |
|----------|--|
| SRF300   | Repeatable, RF relay   |
| SRF300D  | Repeatable, RF relay with internal diode for coil transient suppression  |
| SRF300DD | Repeatable, RF relay with internal diodes for coil transient suppression and polarity reversal protection            |
| SRF303   | Sensitive, repeatable, RF relay  |
| SRF303D  | Sensitive, repeatable, RF relay with internal diode for coil transient suppression                                   |
| SRF303DD | Sensitive, repeatable, RF relay with internal diodes for coil transient suppression and polarity reversal protection |

**DESCRIPTION**

The ultraminiature SRF300 and SRF303 relays are designed to provide a practical surface-mount solution with improved RF signal repeatability over the frequency range. These relays are engineered for use in RF attenuator, RF switch matrices, ATE and other applications that require dependable high frequency signal fidelity and performance.

The SRF300 and SRF303 feature:

- High repeatability
- Broader bandwidth
- Metal enclosure for EMI shielding
- High isolation between control and signal paths
- High resistance to ESD

The following unique construction features and manufacturing techniques provide excellent robustness to environmental

extremes and overall high reliability:

- Uniframe motor design provides high magnetic efficiency and mechanical rigidity
- Minimum mass components and welded construction provide maximum resistance to shock and vibration
- Advanced cleaning techniques provide maximum assurance of internal cleanliness
- Hermetically sealed
- Solder Dipped Leads, (RoHS compliant solder option available)

The Series SRF300D/SRF303D and SRF300DD/SRF303DD relays have internal discrete silicon diodes for coil suppression and polarity reversal protection. This hybrid package reduces required PC board floor space by reducing the number of external components needed to drive the relay.

| ENVIRONMENTAL AND PHYSICAL SPECIFICATIONS |                  |                          |
|---|------------------|--------------------------|
| <b>Temperature</b><br>(Ambient)           | <b>Storage</b>   | -65°C to +125°C          |
|   | <b>Operating</b> | -55°C to +85°C           |
| <b>Vibration</b><br>(General Note I)      |                  | 10 g's to 500 Hz         |
| <b>Shock</b><br>(General Note I)          |                  | 30 g's,<br>6ms half sine |
| <b>Enclosure</b>                          |                  | Hermetically sealed      |
| <b>Weight</b>                             | <b>SRF300</b>    | 0.09 oz. (2.55g) max.    |
|   | <b>SRF303</b>    | 0.16 oz. (4.5g) max.     |

**INTERNAL CONSTRUCTION**

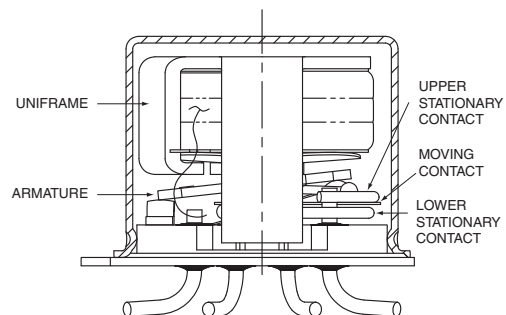

**SERIES SRF300/SRF303**  
**TYPICAL RF CHARACTERISTICS (See RF Notes)**

SRF300YZ Isolation Across Contacts (RF Note 4)

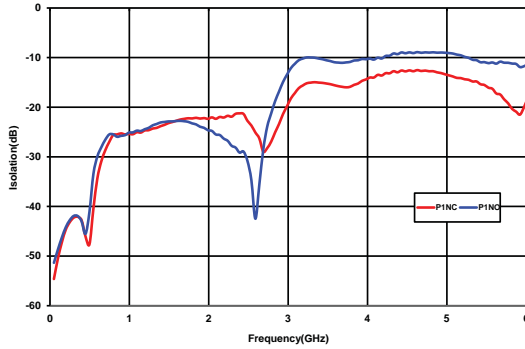

SRF300YZ Pole-Pole Isolation (RF Note 5)

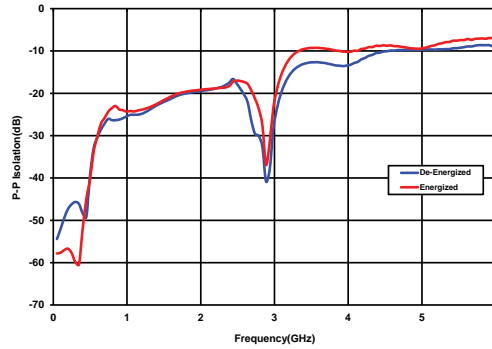

SRF300YZ Insertion Loss (RF Note 6)

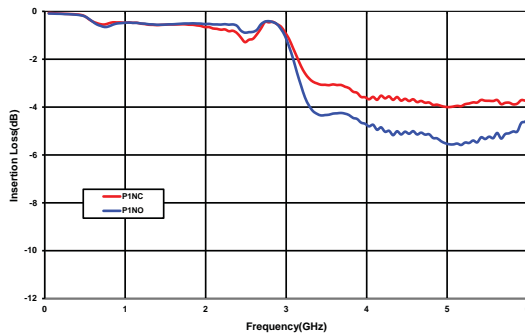

SRF300YZ VSWR (RF Note 6)

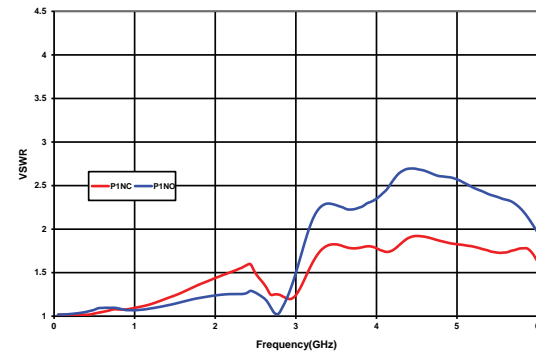

SRF300/SRF303 Time Response (RF Note 6)

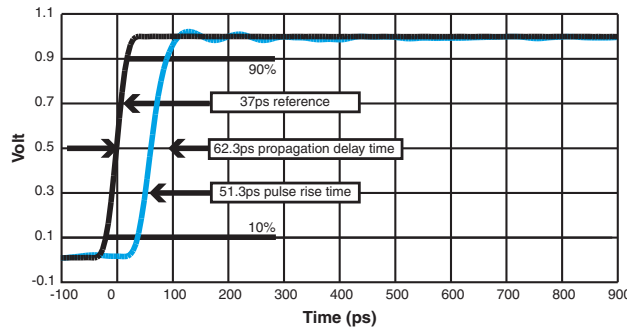

**RF NOTES**

1. Test conditions:
  - a. Fixture: .031" copper clad, reinforced PTFE, RT/duroid® 6002 with SMA connectors. (RT/duroid® is a registered trademark of Rogers Corporation.)
  - b. RF ground shield is soldered to PCB RF ground plane.
  - c. Room ambient temperature.
  - d. Terminals not tested were terminated with 50-ohm load.
  - e. Contact signal level: -10 dBm.
  - f. No. of test samples: 2.
2. Data presented herein represents typical characteristics and is not intended for use as specification limits.
3. Data is per pole, except for pole-to-pole data.
4. Data is the average from readings taken on all open contacts.
5. Data is the average from readings taken on poles with coil energized and de-energized.
6. Data is the average from readings taken on all closed contacts.
7. Test fixture effect de-embedded from frequency and time response data.

### SERIES SRF300/SRF303 GENERAL ELECTRICAL SPECIFICATIONS (@25°C)

|                                      |   |                                  |
|--------------------------------------|---|----------------------------------|
| <b>Contact Arrangement</b>           | 2 Form C (DPDT)   |                                  |
| <b>Rated Duty</b>                    | Continuous  |                                  |
| <b>Contact Resistance</b>            | 0.15 Ω max.   |                                  |
| <b>Contact Load Rating</b>           | Resistive: 1Amp/28Vdc<br>Low level: 10 to 50 μA @ 10 to 50 mV |                                  |
| <b>Contact Life Ratings</b>          | 10,000,000 cycles (typical) at low level                      |                                  |
| <b>Coil Operating Power</b>          | SRF300-5: 500 mW @ nominal coil                               | SRF300-12: 370 mW @ nominal coil |
|                                      | SRF303-5: 250 mW @ nominal coil                               | SRF303-12: 169 mW @ nominal coil |
| <b>Operate Time</b>                  | SRF300: 4.0 mS max.<br>SRF303: 6.0 mS max.                    |                                  |
| <b>Release Time</b>                  | SRF300: 3.0 mS max.   | SRF300D, SRF300DD: 4.0 mS max.   |
|                                      | SRF303: 3.0 mS max.   | SRF303D, SRF303DD: 7.5 mS max.   |
| <b>Intercontact Capacitance</b>      | 0.4 pf typical  |                                  |
| <b>Insulation Resistance</b>         | 1,000 MΩ min. between mutually isolated terminals             |                                  |
| <b>Dielectric Strength</b>           | 350 Vrms (60 Hz) @ atmospheric pressure                       |                                  |
| <b>Negative Coil Transient (Vdc)</b> | SRF300D/SRF303D,<br>SRF300DD/SRF303DD                         | 1.0 max                          |
| <b>Diode P.I.V. (Vdc)</b>            | SRF300D/SRF303D,<br>SRF300DD/SRF303DD                         | 100 min.                         |

### DETAILED ELECTRICAL SPECIFICATIONS (@25°C)

| BASE PART NUMBERS (SRF300, SRF300D, SRF300DD)      | SRF300-5<br>SRF300D-5<br>SRF300DD-5 | SRF300-12<br>SRF300D-12<br>SRF300DD-12 |
|--|-------------------------------------|--|
| <b>Coil Voltage, Nominal (Vdc)</b>                 | 5.0                                 | 12.0                                   |
| <b>Coil Resistance (Ohms ±20%)</b>                 | SRF300, SRF300D                     | 390                                    |
|  | SRF300DD (General Note II)          | 390                                    |
| <b>Coil Current (mAdc @ 25 °C)(RF300DD Series)</b> | Min.                                | 25.6                                   |
|  | Max.                                | 32.8                                   |
| <b>Pick-up Voltage (Vdc max.)</b>                  | SRF300, SRF300D,                    | 9.0                                    |
|  | SRF300DD                            | 10.0                                   |

| BASE PART NUMBERS (SRF303, SRF303D, SRF303DD)      | SRF303-5<br>SRF303D-5<br>SRF303DD-5 | SRF303-12<br>SRF303D-12<br>SRF303DD-12 |
|--|-------------------------------------|--|
| <b>Coil Voltage, Nominal (Vdc)</b>                 | 5.0                                 | 12.0                                   |
| <b>Coil Resistance (Ohms ±20%)</b>                 | SRF303, SRF303D                     | 850                                    |
|  | SRF303DD (General Note II)          | 850                                    |
| <b>Coil Current (mAdc @ 25 °C)(RF303DD Series)</b> | Min.                                | 11.7                                   |
|  | Max.                                | 15.0                                   |
| <b>Pick-up Voltage (Vdc max.)</b>                  | SRF303, SRF303D,                    | 9.0                                    |
|  | SRF303DD                            | 11.0                                   |

**SERIES SRF300/SRF303  
OUTLINE DIMENSIONS**



(Viewed From Terminals)

**SCHEMATIC DIAGRAMS**



SRF300/RF303

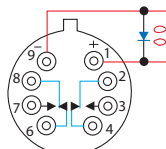

SRF300D/SRF303D

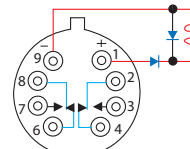

SRF300DD/SRF303DD

**NOTES:**

1. DIMENSIONS ARE IN INCHES, METRIC EQUIVALENTS SHOWN IN ( ).
2. POSITIONS 5 AND 10 ARE FOR UNINSULATED CASE GROUND OPTIONS.
3. NO PROTRUSION BELOW BOTTOM OF HEADER WHEN GROUND PINS ARE INSTALLED
4. TO ORDER THE CASE GROUND OPTION, AFTER THE SERIES DESIGNATOR, ADD "Y" TO THE PART NUMBER FOR POSITION 5 OR "Z" TO THE PART NUMBER FOR POSITION 10.

**Teledyne Part Numbering System for SRF300/SRF303 Relays**

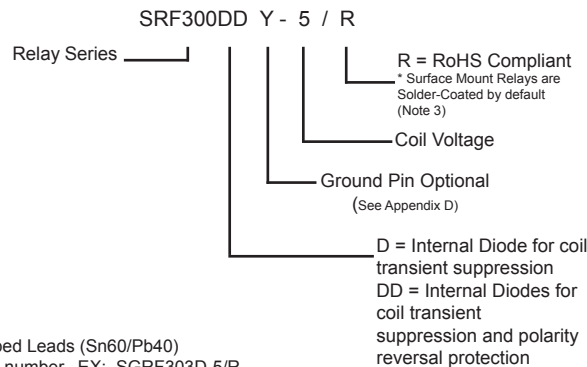

**NOTES:**

- 1 Standard Relay lead finish: Solder-Dipped Leads (Sn60/Pb40)
- 2 For RoHS Solder, add /R at end of part number. EX: SGRF303D-5/R  
RoHS Solder: (Sn99.3/Cu0.7)
- 3 The slash and characters appearing after the slash are not marked on the relay.

**GENERAL NOTES**

- Relays will exhibit no contact chatter in excess of 10  $\mu$ sec or transfer in excess of 1  $\mu$ sec.
- For reference only. Coil resistance not directly measureable at relay terminals due to internal series diode.

**SERIES SRF300/SRF303**  
**TYPICAL SIGNAL INTEGRITY CHARACTERISTICS @ 10 Gbps**

**Normally Closed (Typ.)**

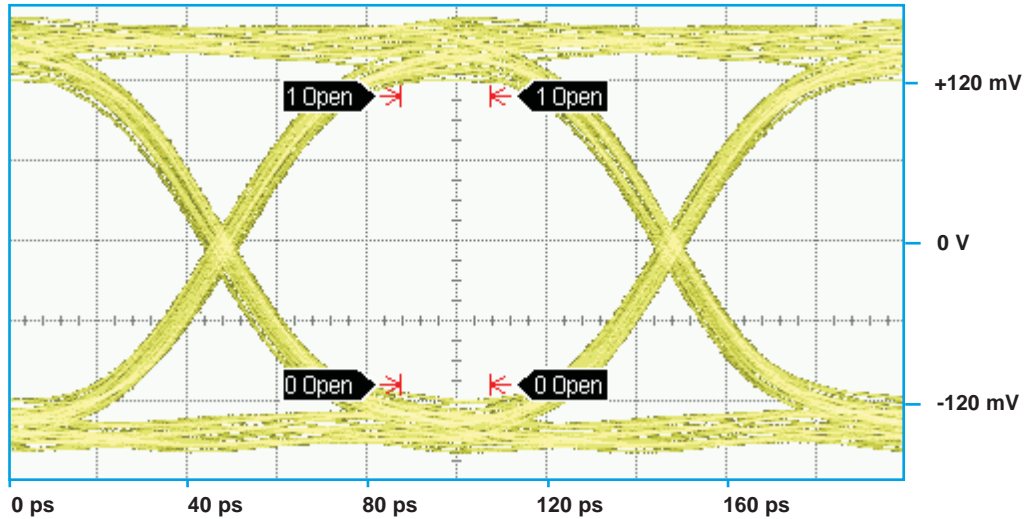

| Bit Rate | Eye Height | Eye Width | Jitter <sub>P-P</sub> |
|----------|------------|-----------|-----------------------|
| 10 Gbps  | 137.9 mV   | 85.83 ps  | 13.33 ps              |

**Normally Open (Typ.)**



| Bit Rate | Eye Height | Eye Width | Jitter <sub>P-P</sub> |
|----------|------------|-----------|-----------------------|
| 10 Gbps  | 72.8 mV    | 88.1 ps   | 8.00 ps               |

**PATTERN GENERATOR SETTINGS**

- 10 Gbps Random Pulse Pattern Generator
- $2^{31} - 1$  PRBS signal
- PRBS output of 300 mV<sub>P-P</sub> (nominal)
- RF PCB effect (negligible) not removed from measurement
- Data shown is typical of both poles

**SERIES SRF300/SRF303**  
**TYPICAL SIGNAL INTEGRITY CHARACTERISTICS @ 18 Gbps**

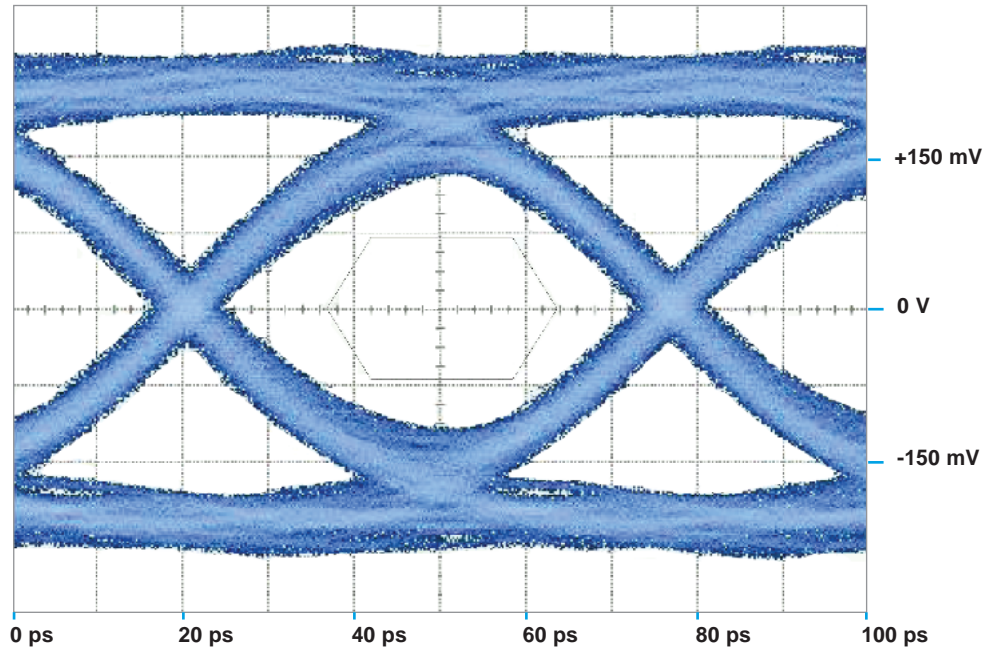

| Bit Rate | Eye Height | Eye Width | Jitter <sub>P-P</sub> |
|----------|------------|-----------|-----------------------|
| 18 Gbps  | 185 mV     | 46.4 ps   | 10.44 ps              |

**PATTERN GENERATOR SETTINGS**

- 18 Gbps Random Pulse Pattern Generator
- $2^{31} - 1$  PRBS signal
- PRBS output of 300 mV<sub>P-P</sub> (nominal)
- RF PCB effect (negligible) not removed from measurement
- Data shown is typical of both poles

## Данный компонент на территории Российской Федерации

### Вы можете приобрести в компании MosChip.

Для оперативного оформления запроса Вам необходимо перейти по данной ссылке:

<http://moschip.ru/get-element>

Вы можете разместить у нас заказ для любого Вашего проекта, будь то серийное производство или разработка единичного прибора.

В нашем ассортименте представлены ведущие мировые производители активных и пассивных электронных компонентов.

Нашей специализацией является поставка электронной компонентной базы двойного назначения, продукции таких производителей как XILINX, Intel (ex.ALTERA), Vicor, Microchip, Texas Instruments, Analog Devices, Mini-Circuits, Amphenol, Glenair.

Сотрудничество с глобальными дистрибьюторами электронных компонентов, предоставляет возможность заказывать и получать с международных складов практически любой перечень компонентов в оптимальные для Вас сроки.

На всех этапах разработки и производства наши партнеры могут получить квалифицированную поддержку опытных инженеров.

Система менеджмента качества компании отвечает требованиям в соответствии с ГОСТ Р ИСО 9001, ГОСТ РВ 0015-002 и ЭС РД 009

### Офис по работе с юридическими лицами:

105318, г.Москва, ул.Щербаковская д.3, офис 1107, 1118, ДЦ «Щербаковский»

Телефон: +7 495 668-12-70 (многоканальный)

Факс: +7 495 668-12-70 (доб.304)

E-mail: [info@moschip.ru](mailto:info@moschip.ru)

Skype отдела продаж:

moschip.ru

moschip.ru\_4

moschip.ru\_6

moschip.ru\_9