

SURFACE MOUNT HIGH REPEATABILITY, BROADBAND TO-5 RELAYS DPDT



SERIES	RELAY TYPE
SRF300	Repeatable, RF relay
SRF300D	Repeatable, RF relay with internal diode for coil transient suppression
SRF300DD	Repeatable, RF relay with internal diodes for coil transient suppression and polarity reversal protection
SRF303	Sensitive, repeatable, RF relay
SRF303D	Sensitive, repeatable, RF relay with internal diode for coil transient suppression
SRF303DD	Sensitive, repeatable, RF relay with internal diodes for coil transient suppression and polarity reversal protection

DESCRIPTION

The ultraminiature SRF300 and SRF303 relays are designed to provide a practical surface-mount solution with improved RF signal repeatability over the frequency range. These relays are engineered for use in RF attenuator, RF switch matrices, ATE and other applications that require dependable high frequency signal fidelity and performance.

The SRF300 and SRF303 feature:

- High repeatability
- Broader bandwidth
- Metal enclosure for EMI shielding
- High isolation between control and signal paths
- High resistance to ESD

The following unique construction features and manufacturing techniques provide excellent robustness to environmental

extremes and overall high reliability:

- Uniframe motor design provides high magnetic efficiency and mechanical rigidity
- Minimum mass components and welded construction provide maximum resistance to shock and vibration
- Advanced cleaning techniques provide maximum assurance of internal cleanliness
- Hermetically sealed
- Solder Dipped Leads, (RoHS compliant solder option available)

The Series SRF300D/SRF303D and SRF300DD/SRF303DD relays have internal discrete silicon diodes for coil suppression and polarity reversal protection. This hybrid package reduces required PC board floor space by reducing the number of external components needed to drive the relay.

ENVIRONMENTAL AND PHYSICAL SPECIFICATIONS

Temperature (Ambient)	Storage	-65°C to +125°C
	Operating	-55°C to +85°C
Vibration (General Note I)		10 g's to 500 Hz
Shock (General Note I)		30 g's, 6ms half sine
Enclosure		Hermetically sealed
Weight	SRF300	0.09 oz. (2.55g) max.
	SRF303	0.16 oz. (4.5g) max.

INTERNAL CONSTRUCTION

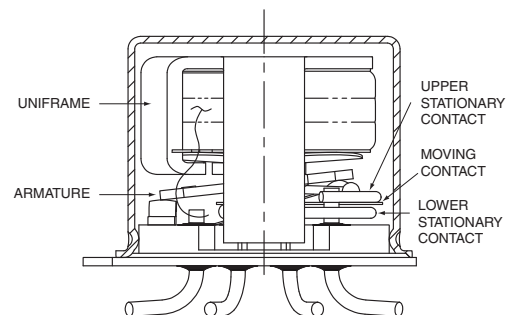

SERIES SRF300/SRF303
TYPICAL RF CHARACTERISTICS (See RF Notes)

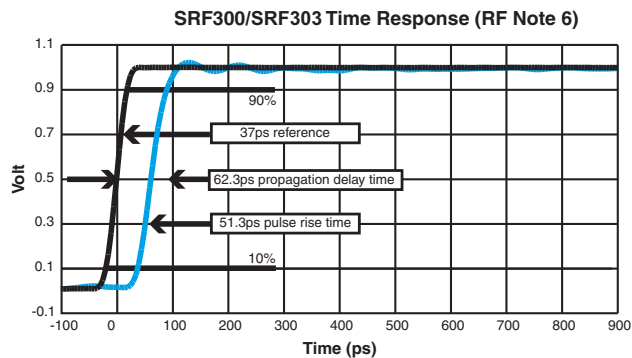
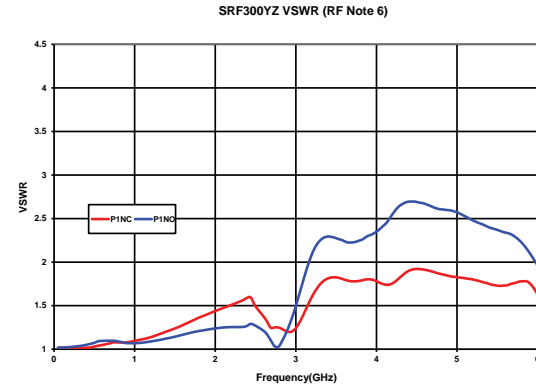
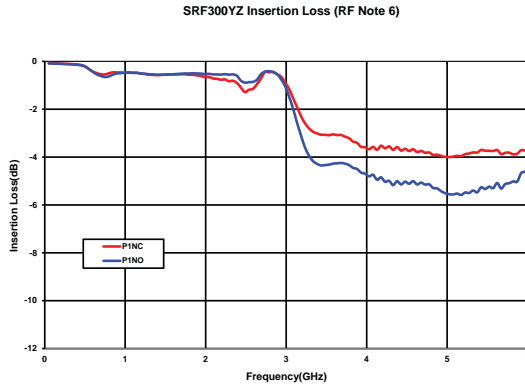
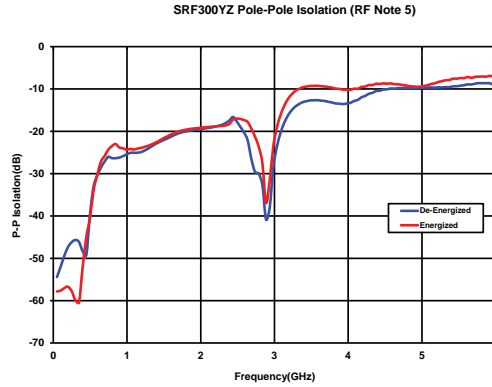
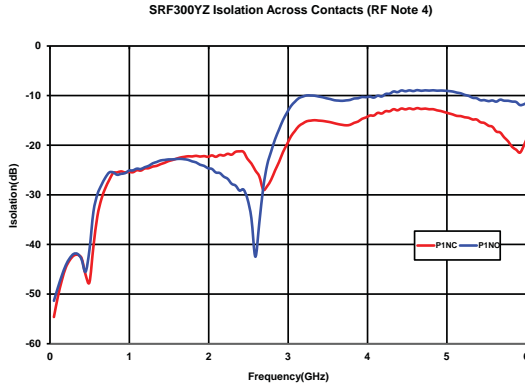

RF NOTES

- Test conditions:
 - Fixture: .031" copper clad, reinforced PTFE, RT/duroid® 6002 with SMA connectors. (RT/duroid® is a registered trademark of Rogers Corporation.)
 - RF ground shield is soldered to PCB RF ground plane.
 - Room ambient temperature.
 - Terminals not tested were terminated with 50-ohm load.
 - Contact signal level: -10 dBm.
 - No. of test samples: 2.
- Data presented herein represents typical characteristics and is not intended for use as specification limits.
- Data is per pole, except for pole-to-pole data.
- Data is the average from readings taken on all open contacts.
- Data is the average from readings taken on poles with coil energized and de-energized.
- Data is the average from readings taken on all closed contacts.
- Test fixture effect de-embedded from frequency and time response data.

SERIES SRF300/SRF303 GENERAL ELECTRICAL SPECIFICATIONS (@25°C)

Contact Arrangement	2 Form C (DPDT)	
Rated Duty	Continuous	
Contact Resistance	0.15 Ω max.	
Contact Load Rating	Resistive: 1Amp/28Vdc Low level: 10 to 50 μA @ 10 to 50 mV	
Contact Life Ratings	10,000,000 cycles (typical) at low level	
Coil Operating Power	SRF300-5: 500 mW @ nominal coil	SRF300-12: 370 mW @ nominal coil
	SRF303-5: 250 mW @ nominal coil	SRF303-12: 169 mW @ nominal coil
Operate Time	SRF300: 4.0 mS max. SRF303: 6.0 mS max.	
Release Time	SRF300: 3.0 mS max.	SRF300D, SRF300DD: 4.0 mS max.
	SRF303: 3.0 mS max.	SRF303D, SRF303DD: 7.5 mS max.
Intercontact Capacitance	0.4 pf typical	
Insulation Resistance	1,000 MΩ min. between mutually isolated terminals	
Dielectric Strength	350 Vrms (60 Hz) @ atmospheric pressure	
Negative Coil Transient (Vdc)	SRF300D/SRF303D, SRF300DD/SRF303DD	1.0 max
Diode P.I.V. (Vdc)	SRF300D/SRF303D, SRF300DD/SRF303DD	100 min.

DETAILED ELECTRICAL SPECIFICATIONS (@25°C)

BASE PART NUMBERS (SRF300, SRF300D, SRF300DD)	SRF300-5 SRF300D-5 SRF300DD-5	SRF300-12 SRF300D-12 SRF300DD-12
Coil Voltage, Nominal (Vdc)	5.0	12.0
Coil Resistance (Ohms ±20%)	SRF300, SRF300D	50
	SRF300DD (General Note II)	39
Coil Current (mAdc @ 25 °C)(RF300DD Series)	Min.	93.2
	Max.	128.2
Pick-up Voltage (Vdc max.)	SRF300, SRF300D,	3.6
	SRF300DD	3.9

BASE PART NUMBERS (SRF303, SRF303D, SRF303DD)	SRF303-5 SRF303D-5 SRF303DD-5	SRF303-12 SRF303D-12 SRF303DD-12
Coil Voltage, Nominal (Vdc)	5.0	12.0
Coil Resistance (Ohms ±20%)	SRF303, SRF303D	100
	SRF303DD (General Note II)	64
Coil Current (mAdc @ 25 °C)(RF303DD Series)	Min.	56.8
	Max.	78.1
Pick-up Voltage (Vdc max.)	SRF303, SRF303D,	3.6
	SRF303DD	3.7

**SERIES SRF300/SRF303
OUTLINE DIMENSIONS**

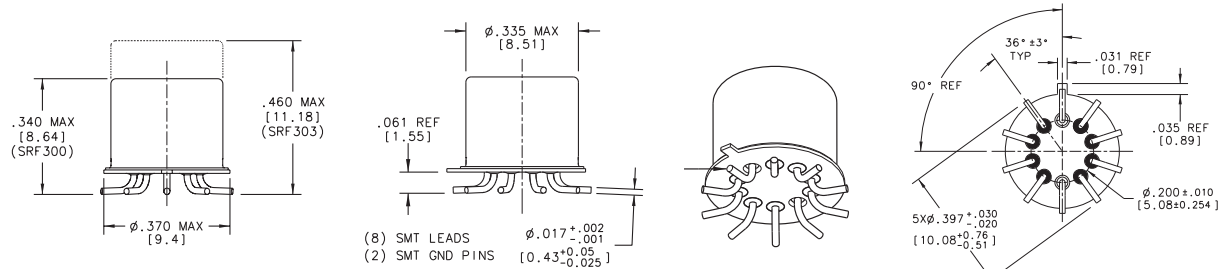

(Viewed From Terminals)

SCHEMATIC DIAGRAMS

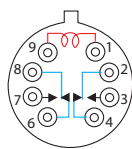

SRF300/RF303

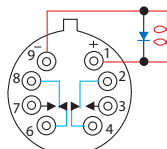

SRF300D/SRF303D

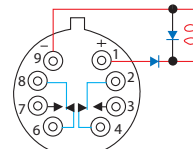

SRF300DD/SRF303DD

NOTES:

1. DIMENSIONS ARE IN INCHES, METRIC EQUIVALENTS SHOWN IN ().
2. POSITIONS 5 AND 10 ARE FOR UNINSULATED CASE GROUND OPTIONS.
3. NO PROTRUSION BELOW BOTTOM OF HEADER WHEN GROUND PINS ARE INSTALLED
4. TO ORDER THE CASE GROUND OPTION, AFTER THE SERIES DESIGNATOR, ADD "Y" TO THE PART NUMBER FOR POSITION 5 OR "Z" TO THE PART NUMBER FOR POSITION 10.

Teledyne Part Numbering System for SRF300/SRF303 Relays

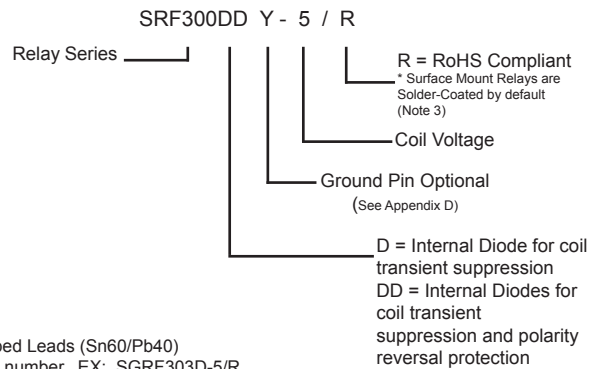

NOTES:

- 1 Standard Relay lead finish: Solder-Dipped Leads (Sn60/Pb40)
- 2 For RoHS Solder, add /R at end of part number. EX: SGRF303D-5/R
RoHS Solder: (Sn99.3/Cu0.7)
- 3 The slash and characters appearing after the slash are not marked on the relay.

GENERAL NOTES

- Relays will exhibit no contact chatter in excess of 10 μ sec or transfer in excess of 1 μ sec.
- For reference only. Coil resistance not directly measureable at relay terminals due to internal series diode.

SERIES SRF300/SRF303
TYPICAL SIGNAL INTEGRITY CHARACTERISTICS @ 10 Gbps

Normally Closed (Typ.)

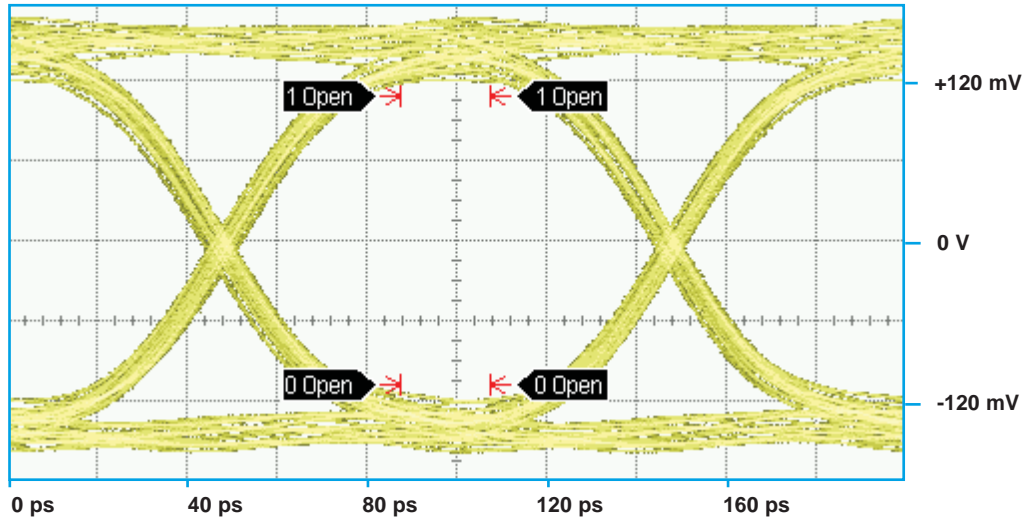

Bit Rate	Eye Height	Eye Width	Jitter _{P-P}
10 Gbps	137.9 mV	85.83 ps	13.33 ps

Normally Open (Typ.)

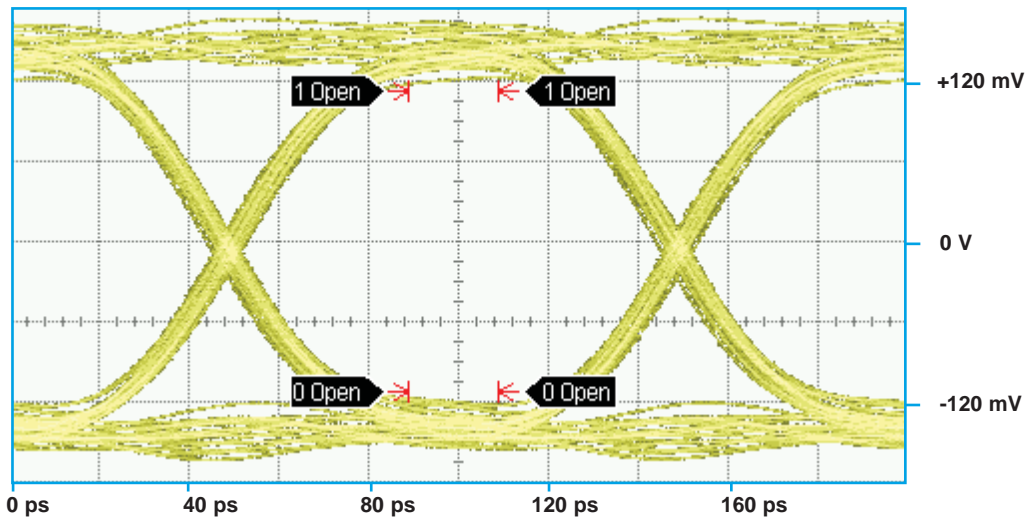

Bit Rate	Eye Height	Eye Width	Jitter _{P-P}
10 Gbps	72.8 mV	88.1 ps	8.00 ps

PATTERN GENERATOR SETTINGS

- 10 Gbps Random Pulse Pattern Generator
- $2^{31} - 1$ PRBS signal
- PRBS output of 300 mV_{P-P} (nominal)
- RF PCB effect (negligible) not removed from measurement
- Data shown is typical of both poles

SERIES SRF300/SRF303
TYPICAL SIGNAL INTEGRITY CHARACTERISTICS @ 18 Gbps

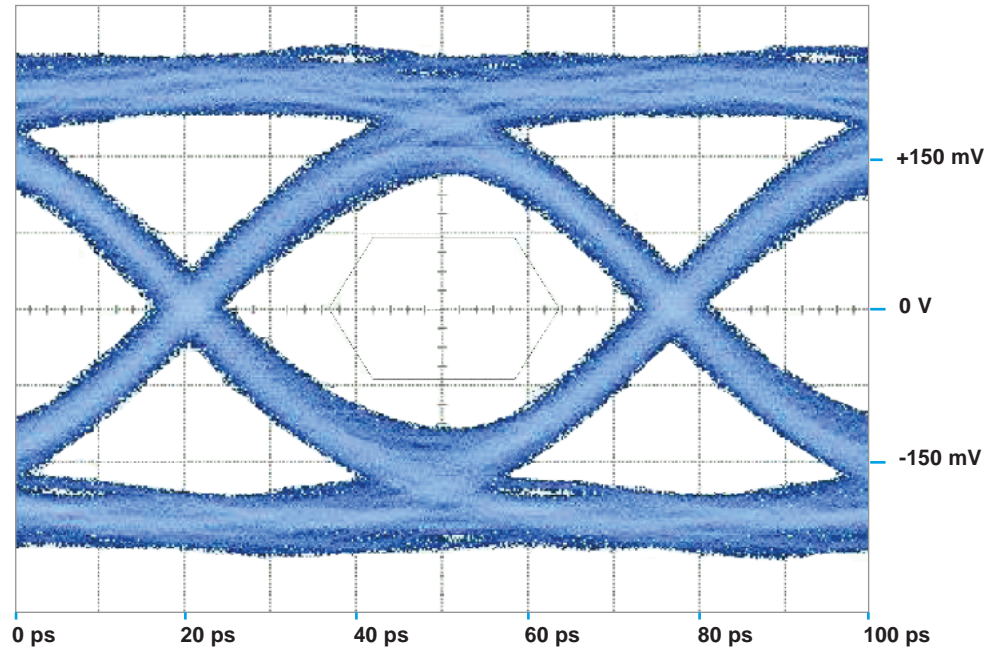

Bit Rate	Eye Height	Eye Width	Jitter _{P-P}
18 Gbps	185 mV	46.4 ps	10.44 ps

PATTERN GENERATOR SETTINGS

- 18 Gbps Random Pulse Pattern Generator
- $2^{31} - 1$ PRBS signal
- PRBS output of 300 mV_{P-P} (nominal)
- RF PCB effect (negligible) not removed from measurement
- Data shown is typical of both poles

Данный компонент на территории Российской Федерации

Вы можете приобрести в компании MosChip.

Для оперативного оформления запроса Вам необходимо перейти по данной ссылке:

<http://moschip.ru/get-element>

Вы можете разместить у нас заказ для любого Вашего проекта, будь то серийное производство или разработка единичного прибора.

В нашем ассортименте представлены ведущие мировые производители активных и пассивных электронных компонентов.

Нашей специализацией является поставка электронной компонентной базы двойного назначения, продукции таких производителей как XILINX, Intel (ex.ALTERA), Vicor, Microchip, Texas Instruments, Analog Devices, Mini-Circuits, Amphenol, Glenair.

Сотрудничество с глобальными дистрибьюторами электронных компонентов, предоставляет возможность заказывать и получать с международных складов практически любой перечень компонентов в оптимальные для Вас сроки.

На всех этапах разработки и производства наши партнеры могут получить квалифицированную поддержку опытных инженеров.

Система менеджмента качества компании отвечает требованиям в соответствии с ГОСТ Р ИСО 9001, ГОСТ РВ 0015-002 и ЭС РД 009

Офис по работе с юридическими лицами:

105318, г.Москва, ул.Щербаковская д.3, офис 1107, 1118, ДЦ «Щербаковский»

Телефон: +7 495 668-12-70 (многоканальный)

Факс: +7 495 668-12-70 (доб.304)

E-mail: info@moschip.ru

Skype отдела продаж:

moschip.ru

moschip.ru_4

moschip.ru_6

moschip.ru_9