

# CUSTOMER DRAWING



**FREE CONNECTOR  
(HELIOS H4 ASSEMBLED)**



**FIXED CONNECTOR  
(HELIOS H4 BULKHEAD - M12)**



**FIXED CONNECTOR  
(HELIOS H4 BULKHEAD - M14)**

### 3. SPECIFICATIONS:

CONTACT SIZE	1.5mm <sup>2</sup> /16AWG	2.5mm <sup>2</sup> /14AWG	4mm <sup>2</sup> /12AWG	6mm <sup>2</sup> /10AWG	10mm <sup>2</sup> /8AWG
RATED CURRENT	35A (UL)				
	N/A	32A (TUV)	40A (TUV)	44A (TUV)	65A (TUV)
RATED SYSTEM VOLTAGE	600V/1000V DC(UL) 1000V DC(TUV)				
CONTACT RESISTANCE	0.25mΩ TYP.				
DEGREE OF PROTECTION, MATED	IP68(1m, 1h)				
PIN CONTACT MATERIAL	COPPER, TIN PLATED				
INSULATION MATERIAL	THERMOPLASTIC, UL94 V-0				
AMBIENT TEMPERATURE RANGE	-40°C TO +85°C				
STRIP LENGTH	7.0 mm				
CABLE JACKET DIAMETER	4.5 TO 7.8mm FOR TUV 1000V RATING 5.25 TO 7.7mm FOR UL 1000V RATING 5.25 TO 7.95mm FOR UL 600V RATING				

2. USE ONLY CRIMP TOOL AMPHENOL H4TC0002 TO CRIMP CONTACTS

1. THIS ASSEMBLY SHALL BE CERTIFIED RoHS COMPLIANT TO THE EUROPEAN UNION DIRECTIVE 2002/95/EC AS AMENDED PER 2005/618/EC.

### NOTES:

THE USE OF THIS DOCUMENT IS UNLIMITED. HOWEVER, DOCUMENTS REFERENCED HEREON MAY CONTAIN LIMITED RIGHTS DATA.

N/A	PRO/ENGINEER INFORMATION
N/A	Pro/e Model Used: CPV-090508-M-ASSEM
N/A	Drawing Name: PV-1005X-000-SF-CUS
N/A	NEXT ASSEMBLY

UNLESS OTHERWISE SPECIFIED	SPECIFICATIONS	POS	QTY	PART NUMBER	DESCRIPTION	NOTE																													
LINEAR DIMENSIONS ARE IN: <b>MILLIMETERS</b> TOLERANCES: ANGLES = ±2°	MATERIAL SPEC.	PARTS LIST																																	
	N/A	<b>AMPHENOL CORPORATION</b> <small>40-60 DELAWARE AVENUE SIDNEY, N.Y. 13838</small>																																	
DIM. & TOL. PER ASME Y14.5M-1994; DRM PER MIL-DTL-31000; OTHER AMPHENOL STANDARDS: 9-9318 LEGENDS: △ = FLAG NOTE CALL OUT REFERENCE ONLY	PROCESS SPEC.	<b>HELIOS H4 1000V/600V CONNECTOR ASSEMBLY</b>																																	
	N/A	<table border="1"> <tr> <td>APPROVALS</td> <td>DATE</td> <td>SIZE</td> <td>CAGE CODE</td> <td>DOCUMENT NO.</td> <td>REV.</td> </tr> <tr> <td>PREPARED BY: LEON LI</td> <td>2012-05-23</td> <td>C</td> <td>77820</td> <td>H4C-( )</td> <td>E</td> </tr> <tr> <td>ENGINEER IN CHARGE</td> <td></td> <td colspan="4">SCALE: 1.0 REF: - SHEET 1 OF 4</td> </tr> <tr> <td>DESIGN MANAGER</td> <td></td> <td colspan="4"></td> </tr> <tr> <td>DESIGN ACTIVITY GROUP: R&amp;D</td> <td></td> <td colspan="4"></td> </tr> </table>					APPROVALS	DATE	SIZE	CAGE CODE	DOCUMENT NO.	REV.	PREPARED BY: LEON LI	2012-05-23	C	77820	H4C-( )	E	ENGINEER IN CHARGE		SCALE: 1.0 REF: - SHEET 1 OF 4				DESIGN MANAGER						DESIGN ACTIVITY GROUP: R&D				
APPROVALS	DATE	SIZE	CAGE CODE	DOCUMENT NO.	REV.																														
PREPARED BY: LEON LI	2012-05-23	C	77820	H4C-( )	E																														
ENGINEER IN CHARGE		SCALE: 1.0 REF: - SHEET 1 OF 4																																	
DESIGN MANAGER																																			
DESIGN ACTIVITY GROUP: R&D																																			
		THIRD ANGLE PROJECTION																																	

## ORDER P/N: H4CFC2DMS

- (BLANK): COLD FORGING CONTACT
- S: STAMPING FORM CONTACT
- I: INDIVIDUAL PACKING WITH PE BAG (800PCS PER BOX)
- C: BULK PACK 100PCS WITH PE BAG (1000PCS PER BOX)
- M: BULK PACK 500PCS PER PE BAG (1000PCS PER BOX)
- D: TUV & UL APPROVAL
- 2: FOR 2.5mm<sup>2</sup>/14AWG CABLE (FOR C&F,  
AND ALSO FOR 1.5 & 2.5mm<sup>2</sup>/16 & 14AWG S&F)
- 4: FOR 4.0mm<sup>2</sup>/12AWG CABLE (FOR C&F,  
AND ALSO FOR 4.0 & 6.0mm<sup>2</sup>/12 & 10AWG S&F)
- 6: FOR 6.0mm<sup>2</sup>/10AWG CABLE (FOR C&F ONLY)
- 8: FOR 10.0mm<sup>2</sup>/8AWG CABLE (FOR C&F ONLY)
- C: CABLE GLAND (FREE CONN)
- M: BULKHEAD M12
- N: BULKHEAD M14
- F: FEMALE
- M: MALE

REVISIONS		
LTR	DESCRIPTION	DATE
A	INITIAL RELEASE	2011-04-18
B	MODIFY THE TOLERANCE	2011-12-05
C	ADD THE INTERFACE DIMENSION	2011-12-14
D	UPGRADE TO 1000V UL RATING	2012-03-20
E	UPDATE TUV MARK	2012-05-23

DOCUMENT NO. H4C-( ) SHEET 1 OF 4 REV. E

DOCUMENT NO. H4C-( ) SHEET 1 OF 4 REV. E

DOCUMENT NO. H4C-( ) SHEET 1 OF 4 REV. E

DOCUMENT NO. H4C-( ) SHEET 1 OF 4 REV. E

PRO/ENGINEER INFORMATION  
Pro/e Model Used:  
CPV-090508-M-ASSEM  
Drawing Name:  
PV-1005X-000-SF-CUS

UNLESS OTHERWISE SPECIFIED  
SPECIFICATIONS  
MATERIAL SPEC.  
N/A  
PROCESS SPEC.  
N/A

APPROVALS  
DATE  
2012-05-23  
THIRD ANGLE PROJECTION

SIZE C CAGE CODE 77820 DOCUMENT NO. H4C-( ) REV. E  
SCALE: 1.0 REF: - SHEET 1 OF 4

### FREE CONNECTOR (HELIOS H4 ASSEMBLED)



### FIXED CONNECTOR (HELIOS H4 BULKHEAD - M12)



### FIXED CONNECTOR (HELIOS H4 BULKHEAD - M14)



- 5. THE MARK OF LETTERS JUST THE VERSION OF THE PLASTIC PARTS FOR AMPHENOL'S MANUFACTURE PROCEDURE, WHEN THE CUSTOMER INSPECT THE PRODUCT, THEY CAN IGNORE THESE NUMBERS.
- 4. FLAT GASKET AND NUT SHOULD NOT BE ASSEMBLED TO THE BODY. SOCKET AND PIN SHOWN INSTALLED FOR REFERENCE ONLY.

THE USE OF THIS DOCUMENT IS UNLIMITED. HOWEVER, DOCUMENTS REFERENCED HEREON MAY CONTAIN LIMITED RIGHTS DATA.

SIZE <b>C</b>	CAGE CODE <b>77820</b>	DOCUMENT NO. <b>H4C-( )</b>	REV. <b>E</b>
SCALE: 1.0	REF: -	SHEET 2 OF 4	

DOCUMENT NO. H4C-( ) REV. SHEET 2 OF 4 E

DOCUMENT NO. H4C-( ) REV. SHEET 2 OF 4 E

# STAMPING & FORM CONTACT



**SOCKET (FEMALE)**



	A (mm)
1.5 & 2.5mm <sup>2</sup>	4.8
4.0 & 6.0mm <sup>2</sup>	5.8



**PIN (MALE)**



## ORDER P/N FOR CONTACTS REEL & PACKING INFO

### H4FF4R

- R: 2000PCS PER REEL
- 2: CABLE SIZE: 1.5 & 2.5mm<sup>2</sup>/16 & 14AWG
- 4: CABLE SIZE: 4.0 & 6.0mm<sup>2</sup>/12 & 10AWG
- F: FOR FEMALE
- M: FOR MALE
- F: STAMPING FORM CONTACTS

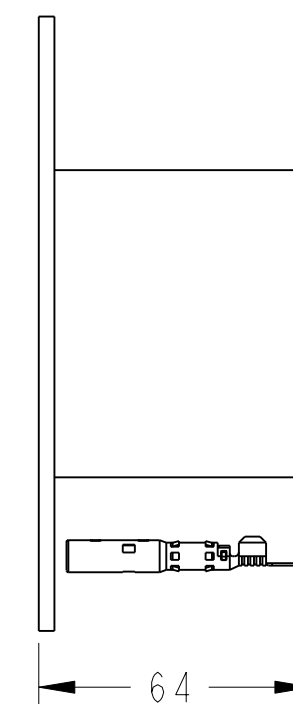
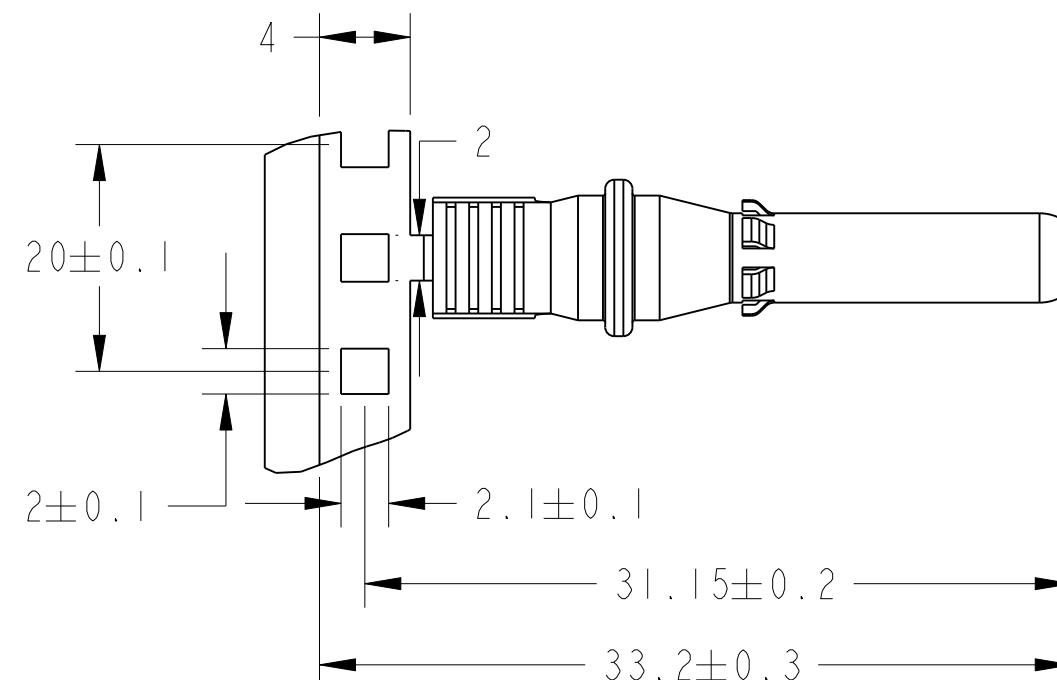
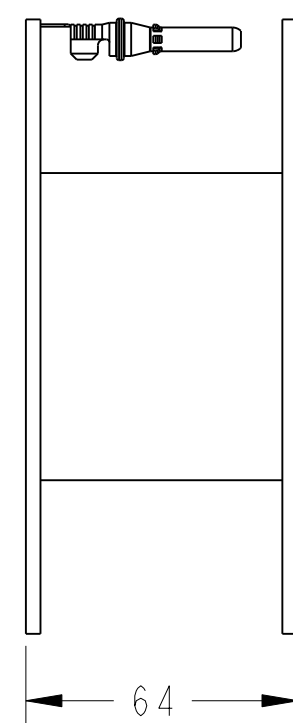

THE USE OF THIS DOCUMENT IS UNLIMITED. HOWEVER, DOCUMENTS REFERENCED HEREON MAY CONTAIN LIMITED RIGHTS DATA.

SIZE C	CAGE CODE 77820	DOCUMENT NO. H4C-( )	REV. E
SCALE: 1.0	REF: -	SHEET 3 OF 4	

# COLD FORGING CONTACT

DOCUMENT NO. H4C-( )  
SHEET 4 OF 4  
REV. E

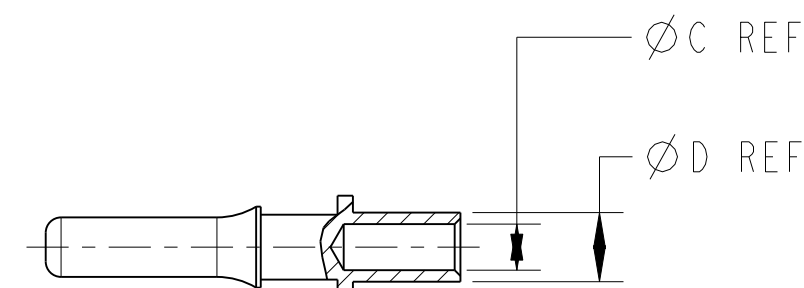
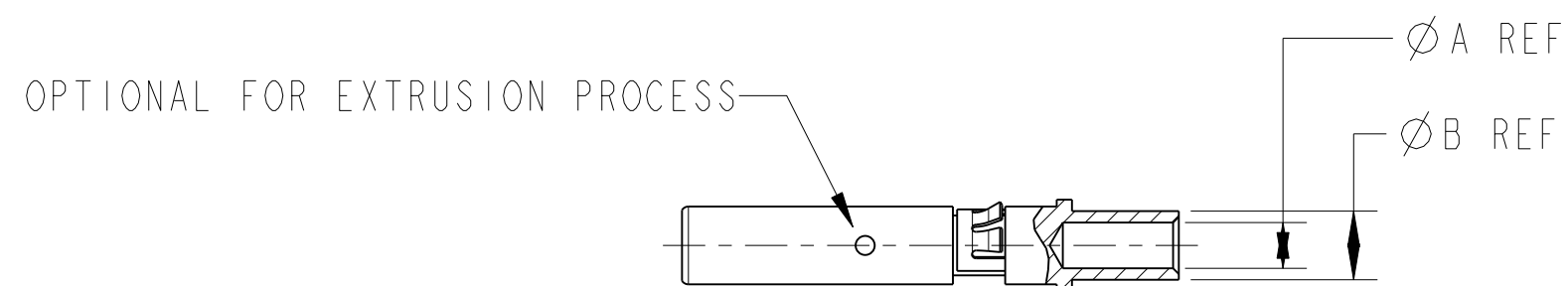
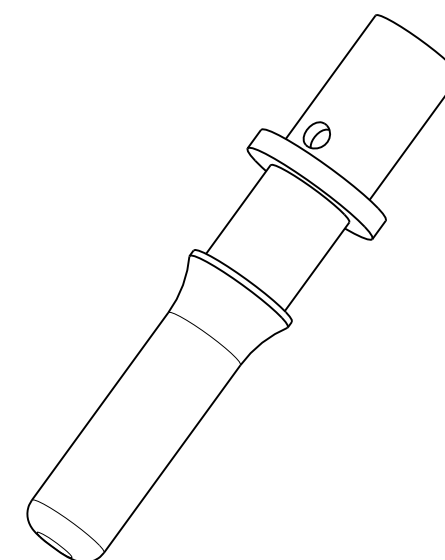
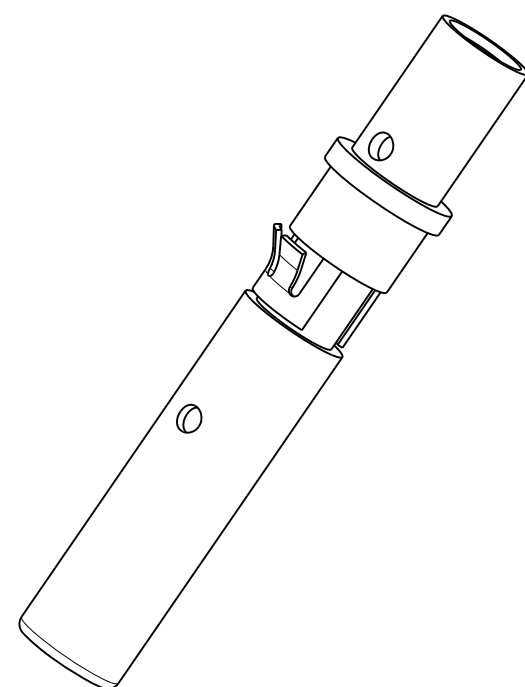

## SOCKET (FEMALE)

## PIN (MALE)

ACCEPT WIRE CONDUCTOR SIZE mm <sup>2</sup> (AWG)	"A"	"B"
2.5 (14)	2.30	3.51
4.0 (12)	3.05	4.57
6.0 (10)	3.76	6.00
10.0(8)	4.50	6.00

ACCEPT WIRE CONDUCTOR SIZE mm <sup>2</sup> (AWG)	"C"	"D"
2.5 (14)	2.30	3.51
4.0 (12)	3.05	4.57
6.0 (10)	3.76	6.00
10.0(8)	4.50	6.00

THE USE OF THIS DOCUMENT IS UNLIMITED.  
HOWEVER, DOCUMENTS REFERENCED HEREON  
MAY CONTAIN LIMITED RIGHTS DATA.

SIZE <b>C</b>	CAGE CODE <b>77820</b>	DOCUMENT NO. <b>H4C-( )</b>	REV. <b>E</b>
SCALE: 1.0	REF: -	SHEET 4 OF 4	

D  
C  
B  
A  
REV. E  
SHEET 4 OF 4  
DOCUMENT NO. H4C-( )

## Данный компонент на территории Российской Федерации

### Вы можете приобрести в компании MosChip.

Для оперативного оформления запроса Вам необходимо перейти по данной ссылке:

<http://moschip.ru/get-element>

Вы можете разместить у нас заказ для любого Вашего проекта, будь то серийное производство или разработка единичного прибора.

В нашем ассортименте представлены ведущие мировые производители активных и пассивных электронных компонентов.

Нашей специализацией является поставка электронной компонентной базы двойного назначения, продукции таких производителей как XILINX, Intel (ex.ALTERA), Vicor, Microchip, Texas Instruments, Analog Devices, Mini-Circuits, Amphenol, Glenair.

Сотрудничество с глобальными дистрибьюторами электронных компонентов, предоставляет возможность заказывать и получать с международных складов практически любой перечень компонентов в оптимальные для Вас сроки.

На всех этапах разработки и производства наши партнеры могут получить квалифицированную поддержку опытных инженеров.

Система менеджмента качества компании отвечает требованиям в соответствии с ГОСТ Р ИСО 9001, ГОСТ РВ 0015-002 и ЭС РД 009

### Офис по работе с юридическими лицами:

105318, г.Москва, ул.Щербаковская д.3, офис 1107, 1118, ДЦ «Щербаковский»

Телефон: +7 495 668-12-70 (многоканальный)

Факс: +7 495 668-12-70 (доб.304)

E-mail: [info@moschip.ru](mailto:info@moschip.ru)

Skype отдела продаж:

moschip.ru

moschip.ru\_4

moschip.ru\_6

moschip.ru\_9