



# Phase Control Thyristors (Stud Version), 330 A



TO- 209AE (TO-118)

### FEATURES

- Center amplifying gate
- International standard case TO-209AE (TO-118)
- Hermetic metal case with ceramic insulator
- Compression bonded encapsulation for heavy duty operations such as severe thermal cycling
- Designed and qualified for industrial level
- Material categorization: for definitions of compliance please see [www.vishay.com/doc?99912](http://www.vishay.com/doc?99912)



RoHS  
COMPLIANT

PRODUCT SUMMARY	
$I_{T(AV)}$	330 A
$V_{DRM}/V_{RRM}$	400 V, 2000 V
$V_{TM}$	1.52 V
$I_{GT}$	200 mA
$T_J$	-40 °C to 125 °C
Package	TO-209AE (TO-118)
Diode variation	Single SCR

### TYPICAL APPLICATIONS

- DC motor controls
- Controlled DC power supplies
- AC controllers

MAJOR RATINGS AND CHARACTERISTICS			
PARAMETER	TEST CONDITIONS	VALUES	UNITS
$I_{T(AV)}$		330	A
	$T_C$	75	°C
$I_{T(RMS)}$		520	A
$I_{TSM}$	50 Hz	9000	
	60 Hz	9420	
$i^2t$	50 Hz	405	kA <sup>2</sup> s
	60 Hz	370	
$V_{DRM}/V_{RRM}$		400 to 2000	V
$t_q$	Typical	100	µs
$T_J$		-40 to 125	°C

### ELECTRICAL SPECIFICATIONS

VOLTAGE RATINGS				
TYPE NUMBER	VOLTAGE CODE	$V_{DRM}/V_{RRM}$ , MAXIMUM REPETITIVE PEAK AND OFF-STATE VOLTAGE V	$V_{RSM}$ , MAXIMUM NON-REPETITIVE PEAK VOLTAGE V	$I_{DRM}/I_{RRM}$ MAXIMUM AT $T_J = T_J$ MAXIMUM mA
VS-ST330S	04	400	500	50
	08	800	900	
	12	1200	1300	
	16	1600	1700	
	20	2000	2100	



<b>ABSOLUTE MAXIMUM RATINGS</b>					
PARAMETER	SYMBOL	TEST CONDITIONS		VALUES	UNITS
Maximum average on-state current at case temperature	$I_{T(AV)}$	180° conduction, half sine wave		330	A
				75	°C
Maximum RMS on-state current	$I_{T(RMS)}$	DC at 75 °C case temperature		520	
Maximum peak, one-cycle non-repetitive surge current	$I_{TSM}$	t = 10 ms	No voltage reapplied	9000	A
		t = 8.3 ms		9420	
		t = 10 ms	100 % $V_{RRM}$ reapplied	7570	
		t = 8.3 ms		7920	
Maximum $I^2t$ for fusing	$I^2t$	t = 10 ms	No voltage reapplied	405	kA <sup>2</sup> s
		t = 8.3 ms		370	
		t = 10 ms	100 % $V_{RRM}$ reapplied	287	
		t = 8.3 ms		262	
Maximum $I^2\sqrt{t}$ for fusing	$I^2\sqrt{t}$	t = 0.1 to 10 ms, no voltage reapplied		4050	kA <sup>2</sup> √s
Low level value of threshold voltage	$V_{T(TO)1}$	(16.7 % $\times \pi \times I_{T(AV)} < I < \pi \times I_{T(AV)}$ , $T_J = T_J$ maximum)		0.834	V
High level value of threshold voltage	$V_{T(TO)2}$	(I > $\pi \times I_{T(AV)}$ , $T_J = T_J$ maximum)		0.898	
Low level value of on-state slope resistance	$r_{t1}$	(16.7 % $\times \pi \times I_{T(AV)} < I < \pi \times I_{T(AV)}$ , $T_J = T_J$ maximum)		0.687	mΩ
High level value of on-state slope resistance	$r_{t2}$	(I > $\pi \times I_{T(AV)}$ , $T_J = T_J$ maximum)		0.636	
Maximum on-state voltage	$V_{TM}$	$I_{pk} = 1000$ A, $T_J = T_J$ maximum, $t_p = 10$ ms sine pulse		1.52	V
Maximum holding current	$I_H$	$T_J = 25$ °C, anode supply 12 V resistive load		600	mA
Typical latching current	$I_L$			1000	

<b>SWITCHING</b>					
PARAMETER	SYMBOL	TEST CONDITIONS		VALUES	UNITS
Maximum non-repetitive rate of rise of turned-on current	$di/dt$	Gate drive 20 V, 20 Ω, $t_r \leq 1$ μs $T_J = T_J$ maximum, anode voltage $\leq 80$ % $V_{DRM}$		1000	A/μs
Typical delay time	$t_d$	Gate current A, $di_g/dt = 1$ A/μs $V_d = 0.67$ % $V_{DRM}$ , $T_J = 25$ °C		1.0	μs
Typical turn-off time	$t_q$	$I_{TM} = 550$ A, $T_J = T_J$ maximum, $di/dt = 40$ A/μs, $V_R = 50$ V, $dV/dt = 20$ V/μs, gate 0 V 100 Ω, $t_p = 500$ μs		100	

<b>BLOCKING</b>					
PARAMETER	SYMBOL	TEST CONDITIONS		VALUES	UNITS
Maximum critical rate of rise of off-state voltage	$dV/dt$	$T_J = T_J$ maximum linear to 80 % rated $V_{DRM}$		500	V/μs
Maximum peak reverse and off-state leakage current	$I_{RRM}$ , $I_{DRM}$	$T_J = T_J$ maximum, rated $V_{DRM}/V_{RRM}$ applied		50	mA



<b>TRIGGERING</b>						
PARAMETER	SYMBOL	TEST CONDITIONS	VALUES		UNITS	
			TYP.	MAX.		
Maximum peak gate power	$P_{GM}$	$T_J = T_J$ maximum, $t_p \leq 5$ ms	10.0		W	
Maximum average gate power	$P_{G(AV)}$	$T_J = T_J$ maximum, $f = 50$ Hz, $d\% = 50$	2.0			
Maximum peak positive gate current	$I_{GM}$	$T_J = T_J$ maximum, $t_p \leq 5$ ms	3.0		A	
Maximum peak positive gate voltage	$+V_{GM}$	$T_J = T_J$ maximum, $t_p \leq 5$ ms	20		V	
Maximum peak negative gate voltage	$-V_{GM}$		5.0			
DC gate current required to trigger	$I_{GT}$	Maximum required gate trigger/ current/voltage are the lowest value which will trigger all units 12 V anode to cathode applied	$T_J = -40$ °C	200	-	mA
			$T_J = 25$ °C	100	200	
			$T_J = 125$ °C	50	-	
DC gate voltage required to trigger	$V_{GT}$		$T_J = -40$ °C	2.5	-	V
			$T_J = 25$ °C	1.8	3	
			$T_J = 125$ °C	1.1	-	
DC gate current not to trigger	$I_{GD}$	$T_J = T_J$ maximum	10		mA	
DC gate voltage not to trigger	$V_{GD}$		0.25		V	

<b>THERMAL AND MECHANICAL SPECIFICATIONS</b>				
PARAMETER	SYMBOL	TEST CONDITIONS	VALUES	UNITS
Maximum operating junction temperature range	$T_J$		-40 to 125	°C
Maximum storage temperature range	$T_{Stg}$		-40 to 150	
Maximum thermal resistance, junction to case	$R_{thJC}$	DC operation	0.10	K/W
Maximum thermal resistance, case to heatsink	$R_{thC-hs}$	Mounting surface, smooth, flat and greased	0.03	
Mounting torque, $\pm 10$ %		Non-lubricated threads	48.5 (425)	N · m (lbf · in)
Approximate weight			535	g
Case style		See dimension - link at the end of datasheet	TO-209AE (TO-118)	

<b><math>\Delta R_{thJC}</math> CONDUCTION</b>				
CONDUCTION ANGLE	SINUSOIDAL CONDUCTION	RECTANGULAR CONDUCTION	TEST CONDITIONS	UNITS
180°	0.011	0.008	$T_J = T_J$ maximum	K/W
120°	0.013	0.014		
90°	0.017	0.018		
60°	0.025	0.026		
30°	0.041	0.042		

**Note**

- The table above shows the increment of thermal resistance  $R_{thJC}$  when devices operate at different conduction angles than DC

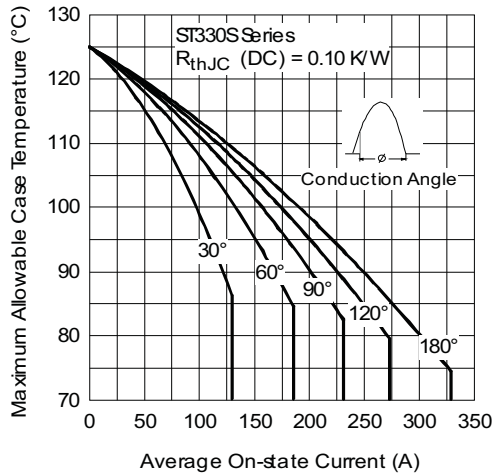

Fig. 1 - Current Ratings Characteristics

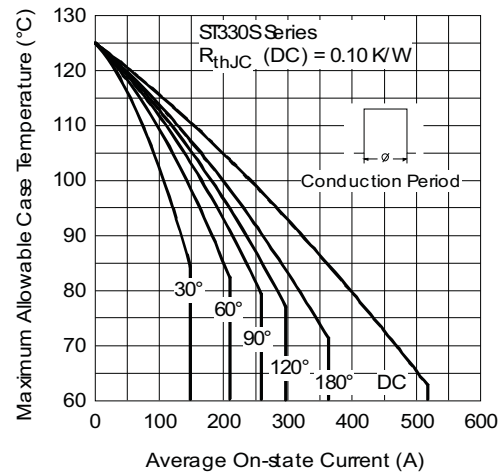

Fig. 2 - Current Ratings Characteristics

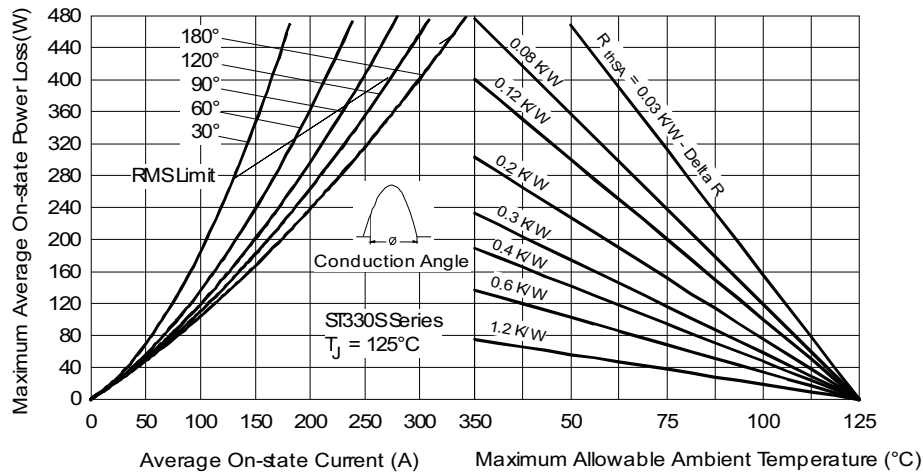

Fig. 3 - On-State Power Loss Characteristics

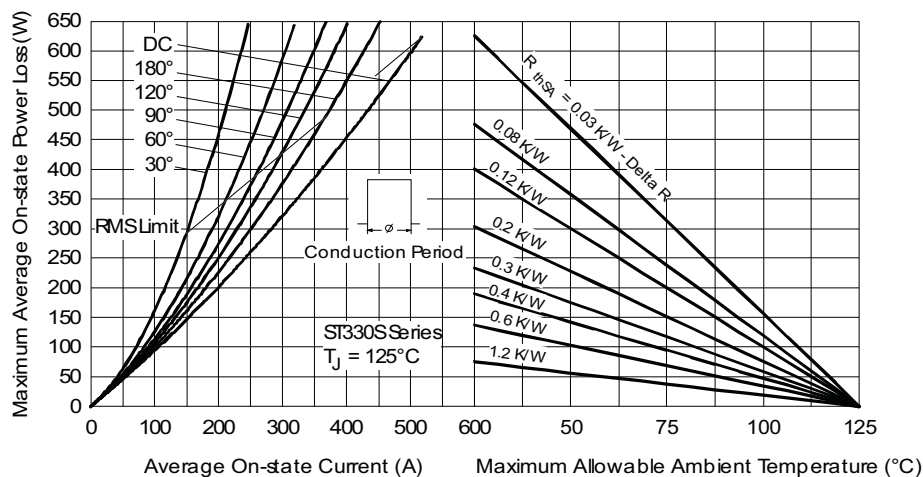

Fig. 4 - On-State Power Loss Characteristics

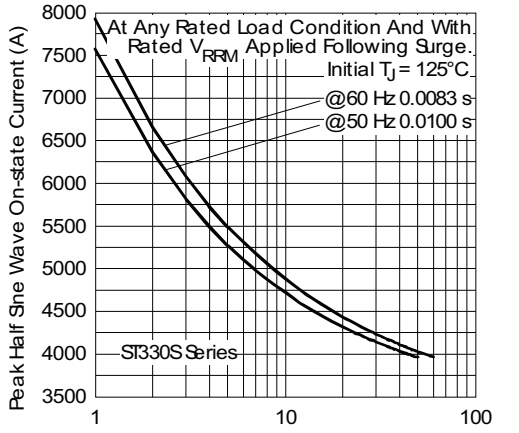

Fig. 5 - Maximum Non-Repetitive Surge Current

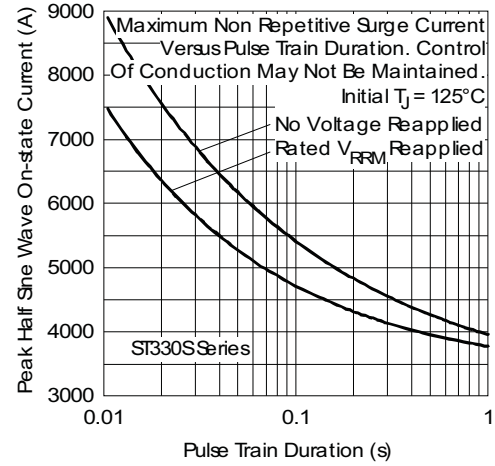

Fig. 6 - Maximum Non-Repetitive Surge Current



Fig. 7 - On-State Voltage Drop Characteristics



Fig. 8 - Thermal Impedance  $Z_{thJC}$  Characteristics

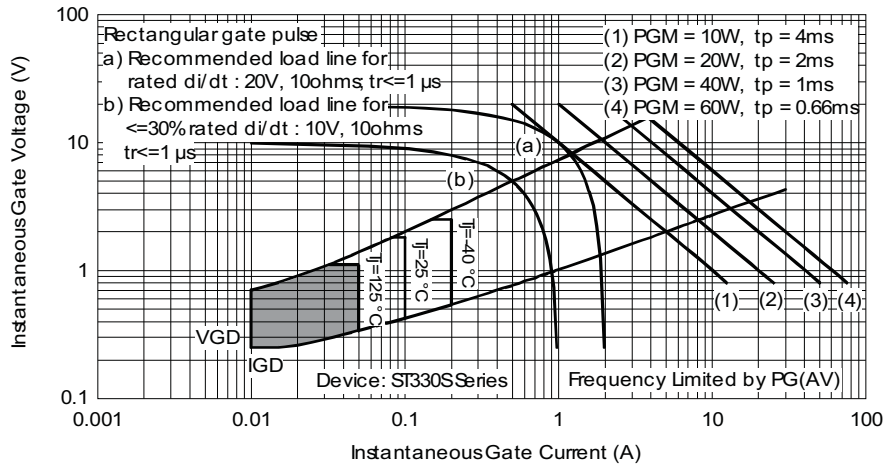

Fig. 9 - Gate Characteristics

## ORDERING INFORMATION TABLE

Device code	<b>VS-</b>	<b>ST</b>	<b>33</b>	<b>0</b>	<b>S</b>	<b>16</b>	<b>P</b>	<b>0</b>	<b>PbF</b>
	(1)	(2)	(3)	(4)	(5)	(6)	(7)	(8)	(9)

- 1** - Vishay Semiconductors product
- 2** - Thyristor
- 3** - Essential part number
- 4** - 0 = Converter grade
- 5** - S = Compression bonding stud
- 6** - Voltage code x 100 =  $V_{RRM}$  (see Voltage Ratings table)
- 7** - P = Stud base 3/4"-16UNF-2A threads
- 8** - 0 = Eyelet terminals (gate and auxiliary cathode leads)  
1 = Fast-on terminals (gate and auxiliary cathode leads)
- 9** - None = Standard production  
- PbF = Lead (Pb)-free

### LINKS TO RELATED DOCUMENTS

Dimensions	<a href="http://www.vishay.com/doc?95080">www.vishay.com/doc?95080</a>
------------	--

## TO-209AE (TO-118)

**DIMENSIONS** in millimeters (inches)

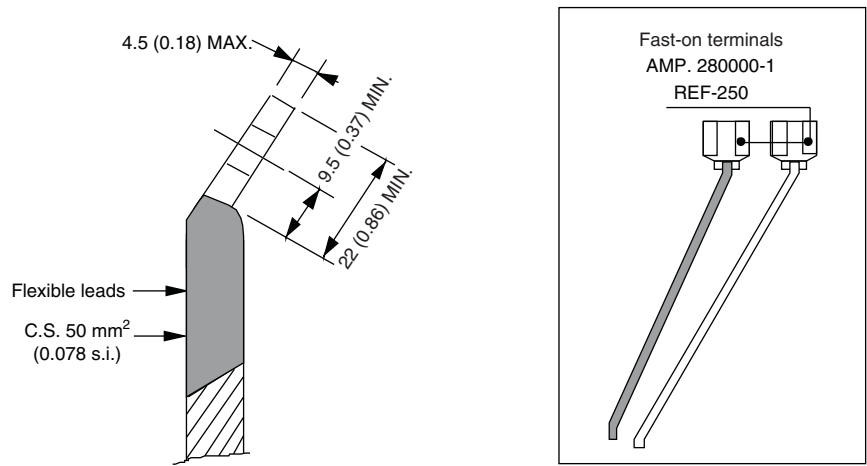

**Note**

<sup>(1)</sup> For metric device: M24 x 1.5 - length 21 (0.83) maximum



## Disclaimer

ALL PRODUCT, PRODUCT SPECIFICATIONS AND DATA ARE SUBJECT TO CHANGE WITHOUT NOTICE TO IMPROVE RELIABILITY, FUNCTION OR DESIGN OR OTHERWISE.

Vishay Intertechnology, Inc., its affiliates, agents, and employees, and all persons acting on its or their behalf (collectively, "Vishay"), disclaim any and all liability for any errors, inaccuracies or incompleteness contained in any datasheet or in any other disclosure relating to any product.

Vishay makes no warranty, representation or guarantee regarding the suitability of the products for any particular purpose or the continuing production of any product. To the maximum extent permitted by applicable law, Vishay disclaims (i) any and all liability arising out of the application or use of any product, (ii) any and all liability, including without limitation special, consequential or incidental damages, and (iii) any and all implied warranties, including warranties of fitness for particular purpose, non-infringement and merchantability.

Statements regarding the suitability of products for certain types of applications are based on Vishay's knowledge of typical requirements that are often placed on Vishay products in generic applications. Such statements are not binding statements about the suitability of products for a particular application. It is the customer's responsibility to validate that a particular product with the properties described in the product specification is suitable for use in a particular application. Parameters provided in datasheets and/or specifications may vary in different applications and performance may vary over time. All operating parameters, including typical parameters, must be validated for each customer application by the customer's technical experts. Product specifications do not expand or otherwise modify Vishay's terms and conditions of purchase, including but not limited to the warranty expressed therein.

Except as expressly indicated in writing, Vishay products are not designed for use in medical, life-saving, or life-sustaining applications or for any other application in which the failure of the Vishay product could result in personal injury or death. Customers using or selling Vishay products not expressly indicated for use in such applications do so at their own risk. Please contact authorized Vishay personnel to obtain written terms and conditions regarding products designed for such applications.

No license, express or implied, by estoppel or otherwise, to any intellectual property rights is granted by this document or by any conduct of Vishay. Product names and markings noted herein may be trademarks of their respective owners.

## Material Category Policy

**Vishay Intertechnology, Inc. hereby certifies that all its products that are identified as RoHS-Compliant fulfill the definitions and restrictions defined under Directive 2011/65/EU of The European Parliament and of the Council of June 8, 2011 on the restriction of the use of certain hazardous substances in electrical and electronic equipment (EEE) - recast, unless otherwise specified as non-compliant.**

**Please note that some Vishay documentation may still make reference to RoHS Directive 2002/95/EC. We confirm that all the products identified as being compliant to Directive 2002/95/EC conform to Directive 2011/65/EU.**

**Vishay Intertechnology, Inc. hereby certifies that all its products that are identified as Halogen-Free follow Halogen-Free requirements as per JEDEC JS709A standards. Please note that some Vishay documentation may still make reference to the IEC 61249-2-21 definition. We confirm that all the products identified as being compliant to IEC 61249-2-21 conform to JEDEC JS709A standards.**



## Данный компонент на территории Российской Федерации

### Вы можете приобрести в компании MosChip.

Для оперативного оформления запроса Вам необходимо перейти по данной ссылке:

<http://moschip.ru/get-element>

Вы можете разместить у нас заказ для любого Вашего проекта, будь то серийное производство или разработка единичного прибора.

В нашем ассортименте представлены ведущие мировые производители активных и пассивных электронных компонентов.

Нашей специализацией является поставка электронной компонентной базы двойного назначения, продукции таких производителей как XILINX, Intel (ex.ALTERA), Vicor, Microchip, Texas Instruments, Analog Devices, Mini-Circuits, Amphenol, Glenair.

Сотрудничество с глобальными дистрибьюторами электронных компонентов, предоставляет возможность заказывать и получать с международных складов практически любой перечень компонентов в оптимальные для Вас сроки.

На всех этапах разработки и производства наши партнеры могут получить квалифицированную поддержку опытных инженеров.

Система менеджмента качества компании отвечает требованиям в соответствии с ГОСТ Р ИСО 9001, ГОСТ РВ 0015-002 и ЭС РД 009

### Офис по работе с юридическими лицами:

105318, г.Москва, ул.Щербаковская д.3, офис 1107, 1118, ДЦ «Щербаковский»

Телефон: +7 495 668-12-70 (многоканальный)

Факс: +7 495 668-12-70 (доб.304)

E-mail: [info@moschip.ru](mailto:info@moschip.ru)

Skype отдела продаж:

moschip.ru

moschip.ru\_4

moschip.ru\_6

moschip.ru\_9