

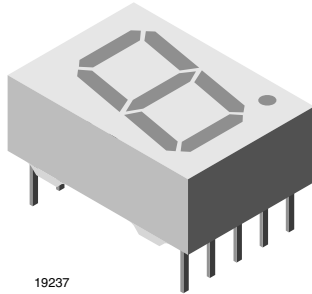

Standard 7-Segment Display 13 mm



19237

DESCRIPTION

The TDS.51.. series are 13 mm character seven segment LED displays in a very compact package. The displays are designed for a viewing distance up to 7 m and available in four bright colors. The grey package surface and the evenly lighted untinted segments provide an optimum on-off contrast. All displays are categorized in luminous intensity groups. That allows users to assemble displays with uniform appearance. Typical applications include instruments, panel meters, point-of-sale terminals and household equipment.

FEATURES

- Evenly lighted segments
- Grey package surface
- Untinted segments
- Luminous intensity categorized
- Yellow and green categorized for color
- Wide viewing angle
- Suitable for DC and high peak current
- Compliant to RoHS directive 2002/95/EC and in accordance to WEEE 2002/96/EC



RoHS COMPLIANT

APPLICATIONS

- Panel meters
- Test- and measure- equipment
- Point-of-sale terminals
- Control units
- TV sets

PRODUCT GROUP AND PACKAGE DATA

- Product group: display
- Package: 13 mm
- Product series: standard
- Angle of half intensity: ± 50°

PARTS TABLE			
PART	COLOR	LUMINOUS INTENSITY AT 10 mA	CIRCUITRY
TDSO5150	Orange red	$I_V > 700 \mu\text{cd}$	Common anode
		$I_V = 5000 \mu\text{cd (typ.)}$	Common anode
TDSO5150-LM	Orange red	$I_V = (2800 \text{ to } 9000) \mu\text{cd}$	Common anode
TDSO5150-M	Orange red	$I_V = (4500 \text{ to } 9000) \mu\text{cd}$	Common anode
TDSO5160	Orange red	$I_V > 700 \mu\text{cd}$	Common cathode
		$I_V = 5000 \mu\text{cd (typ.)}$	Common cathode
TDSO5160-LM	Orange red	$I_V = (2800 \text{ to } 9000) \mu\text{cd}$	Common cathode
TDSY5150	Yellow	$I_V > 700 \mu\text{cd}$	Common anode
		$I_V = 4200 \mu\text{cd (typ.)}$	Common anode
TDSY5160	Yellow	$I_V > 700 \mu\text{cd}$	Common cathode
		$I_V = 4200 \mu\text{cd (typ.)}$	Common cathode
TDSG5150	Green	$I_V > 700 \mu\text{cd}$	Common anode
		$I_V = 9500 \mu\text{cd (typ.)}$	Common anode
TDSG5150-MN	Green	$I_V = (4500 \text{ to } 14\ 000) \mu\text{cd}$	Common anode
TDSG5150-N	Green	$I_V = (7000 \text{ to } 14\ 000) \mu\text{cd}$	Common anode
TDSG5160	Green	$I_V > 700 \mu\text{cd}$	Common cathode
		$I_V = 9500 \mu\text{cd (typ.)}$	Common cathode
TDSG5160-MN	Green	$I_V = (4500 \text{ to } 14\ 000) \mu\text{cd}$	Common cathode
TDSG5160-N	Green	$I_V = (7000 \text{ to } 14\ 000) \mu\text{cd}$	Common cathode

ABSOLUTE MAXIMUM RATINGS ($T_{amb} = 25\text{ }^{\circ}\text{C}$, unless otherwise specified) TDSO5150, TDSO5160, TDSY5150, TDSY5160, TDSG5150, TDSG5160					
PARAMETER	TEST CONDITION	SYMBOL	VALUE	UNIT	
Reverse voltage per segment or DP		V_R	6	V	
DC forward current per segment or DP	TDSO5150	I_F	25	mA	
	TDSO5160		25		
	TDSY5150		25		
	TDSY5160		25		
	TDSG5150		25		
	TDSG5160		25		
Surge forward current per segment or DP	$t_p \leq 10\text{ }\mu\text{s}$ (non repetitive)	I_{FSM}	0.15	A	
	TDSO5150		0.15		
	TDSO5160		0.15		
	TDSY5150		0.15		
	TDSY5160		0.15		
	TDSG5150		0.15		
Power dissipation	$T_{amb} \leq 45\text{ }^{\circ}\text{C}$	P_V	550	mW	
Junction temperature		T_j	100	$^{\circ}\text{C}$	
Operating temperature range		T_{amb}	- 40 to + 85	$^{\circ}\text{C}$	
Storage temperature range		T_{stg}	- 40 to + 85	$^{\circ}\text{C}$	
Soldering temperature	$t \leq 3\text{ s}$, 2 mm below seating plane	T_{sd}	260	$^{\circ}\text{C}$	
Thermal resistance LED junction/ambient		R_{thJA}	100	K/W	

OPTICAL AND ELECTRICAL CHARACTERISTICS ($T_{amb} = 25\text{ }^{\circ}\text{C}$, unless otherwise specified) TDSO5150, TDSO5160, ORANGE RED							
PARAMETER	TEST CONDITION	PART	SYMBOL	MIN.	TYP.	MAX.	UNIT
Luminous intensity per segment (digit average) ⁽¹⁾	$I_F = 10\text{ mA}$	TDSO5150	I_v	700	5000	-	μcd
		TDSO5150-LM		2800	-	9000	
		TDSO5150-M		4500	-	9000	
		TDSO5160		700	5000	-	
		TDSO5160-LM		2800	-	9000	
Dominant wavelength	$I_F = 10\text{ mA}$	TDSO5150, TDSO5160	λ_d	612	-	625	nm
Peak wavelength	$I_F = 10\text{ mA}$		λ_p	-	630	-	nm
Angle of half intensity	$I_F = 10\text{ mA}$		φ	-	± 50	-	deg
Forward voltage per segment or DP	$I_F = 20\text{ mA}$		V_F	-	2	3	V
Reverse voltage per segment or DP	$I_R = 10\text{ }\mu\text{A}$		V_R	6	15	-	V

Note

⁽¹⁾ $I_{vmin.}$ and I_v groups are mean values of all segments (a to g, D1 to D4), matching factor within segments is ≥ 0.5 , excluding decimal points and colon.



TDSG5150, TDSG5160, TDSO5150, TDSO5160, TDSY5150, TDSY5160

Standard 7-Segment Display 13 mm Vishay Semiconductors

OPTICAL AND ELECTRICAL CHARACTERISTICS ($T_{amb} = 25\text{ }^{\circ}\text{C}$, unless otherwise specified) TDSY5150, TDSY5160, YELLOW

PARAMETER	TEST CONDITION	PART	SYMBOL	MIN.	TYP.	MAX.	UNIT
Luminous intensity per segment (digit average) ⁽¹⁾	$I_F = 10\text{ mA}$	TDSY5150	I_V	700	4200	-	μcd
		TDSY5160		700	4200	-	
Dominant wavelength	$I_F = 10\text{ mA}$	TDSY5150, TDSY5160	λ_d	581	-	594	nm
Peak wavelength	$I_F = 10\text{ mA}$		λ_p	-	585	-	nm
Angle of half intensity	$I_F = 10\text{ mA}$		φ	-	± 50	-	deg
Forward voltage per segment or DP	$I_F = 20\text{ mA}$		V_F	-	2.4	3	V
Reverse voltage per segment or DP	$I_R = 10\text{ }\mu\text{A}$		V_R	6	15	-	V

Note

⁽¹⁾ I_{Vmin} and I_V groups are mean values of all segments (a to g, D1 to D4), matching factor within segments is ≤ 0.5 , excluding decimal points and colon.

OPTICAL AND ELECTRICAL CHARACTERISTICS ($T_{amb} = 25\text{ }^{\circ}\text{C}$, unless otherwise specified) TDSG5150, TDSG5160, GREEN

PARAMETER	TEST CONDITION	PART	SYMBOL	MIN.	TYP.	MAX.	UNIT
Luminous intensity per segment (digit average) ⁽¹⁾	$I_F = 10\text{ mA}$	TDSG5150	I_V	700	9500	-	μcd
		TDSG5150-MN		4500	-	14 000	
		TDSG5150-N		7000	-	14 000	
		TDSG5160		700	9500	-	
		TDSG5160-MN		4500	-	14 000	
		TDSG5160-N		7000	-	14 000	
Dominant wavelength	$I_F = 10\text{ mA}$	TDSG5150, TDSG5160	λ_d	562	-	575	nm
Peak wavelength	$I_F = 10\text{ mA}$		λ_p	-	565	-	nm
Angle of half intensity	$I_F = 10\text{ mA}$		φ	-	± 50	-	deg
Forward voltage per segment or DP	$I_F = 20\text{ mA}$		V_F	-	2.4	3	V
Reverse voltage per segment or DP	$I_R = 10\text{ }\mu\text{A}$		V_R	6	15	-	V

Note

⁽¹⁾ I_{Vmin} and I_V groups are mean values of all segments (a to g, D1 to D4), matching factor within segments is ≥ 0.5 , excluding decimal points and colon.

LUMINOUS INTENSITY CLASSIFICATION

GROUP	LIGHT INTENSITY (μcd)	
	MIN.	MAX.
E	180	360
F	280	560
G	450	900
H	700	1400
I	1100	2200
K	1800	3600
L	2800	5600
M	4500	9000
N	7000	14 000

Note

The above type numbers represent the order groups which include only a few brightness groups. Only one group will be shipped in one tube (there will be no mixing of two groups in one tube). In order to ensure availability, single brightness groups will not be orderable.

COLOR CLASSIFICATION

GROUP	ORANGE RED		YELLOW		GREEN	
	MIN.	MAX.	MIN.	MAX.	MIN.	MAX.
1	598	601	581	584		
2	600	603	583	586	562	565
3	602	605	585	588	564	567
4	604	607	587	590	566	569
5	606	609	589	592	568	571
6	608	611	591	594	570	573
7					570	575

Note

Wavelengths are tested at a current pulse duration of 25 ms and an accuracy of $\pm 1\text{ nm}$.

TYPICAL CHARACTERISTICS ($T_{amb} = 25\text{ }^{\circ}\text{C}$, unless otherwise specified)

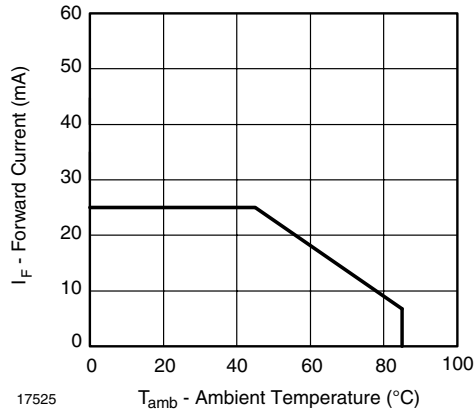

Fig. 1 - Forward Current vs. Ambient Temperature

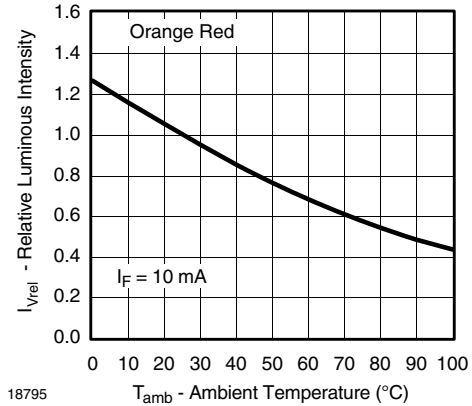

Fig. 4 - Rel. Luminous Intensity vs. Ambient Temperature

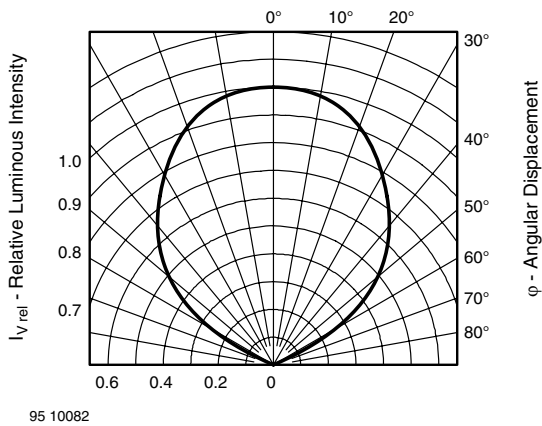

Fig. 2 - Rel. Luminous Intensity vs. Angular Displacement

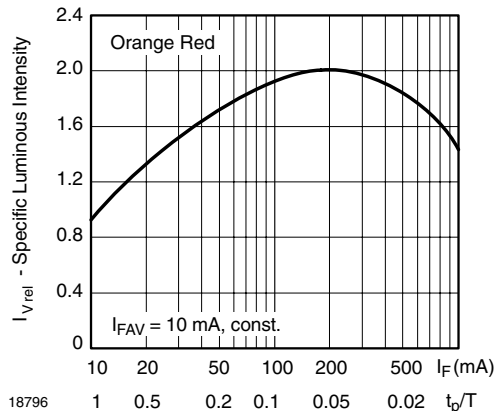

Fig. 5 - Rel. Lumin. Intensity vs. Forw. Current/Duty Cycle

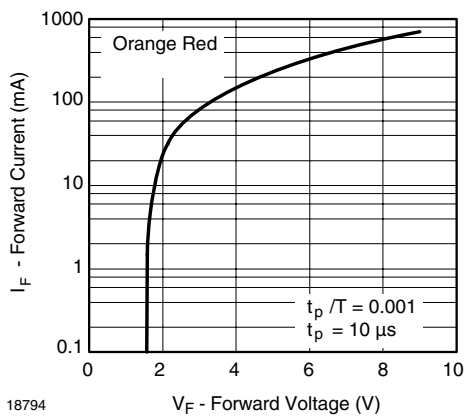

Fig. 3 - Forward Current vs. Forward Voltage

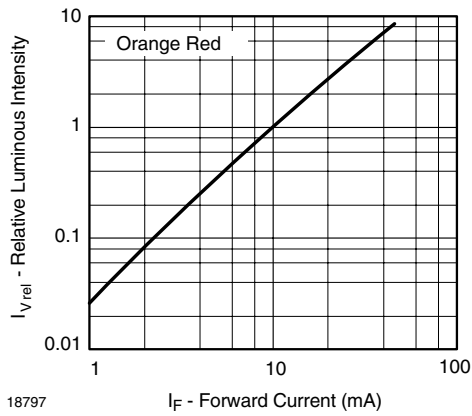

Fig. 6 - Relative Luminous Intensity vs. Forward Current



Fig. 7 - Relative Intensity vs. Wavelength

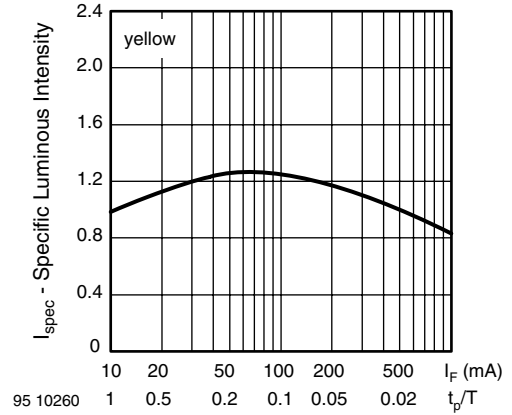

Fig. 10 - Rel. Lumin. Intensity vs. Forw. Current/Duty Cycle

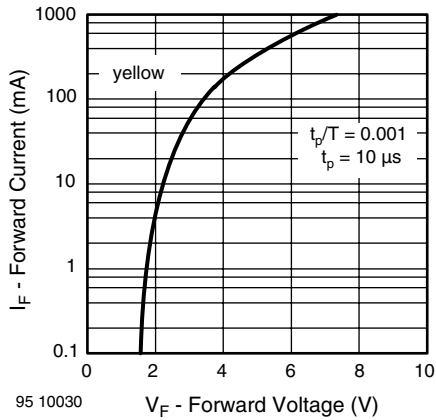

Fig. 8 - Forward Current vs. Forward Voltage

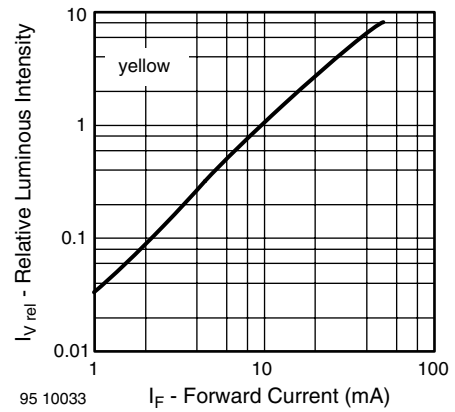

Fig. 11 - Relative Luminous Intensity vs. Forward Current

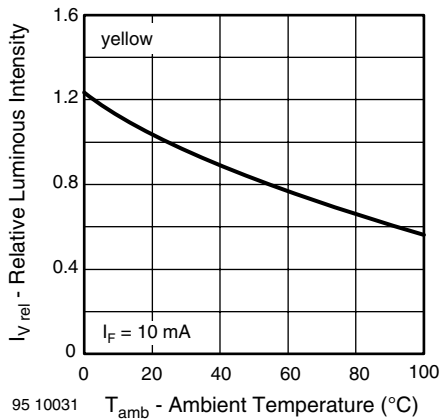

Fig. 9 - Rel. Luminous Intensity vs. Ambient Temperature

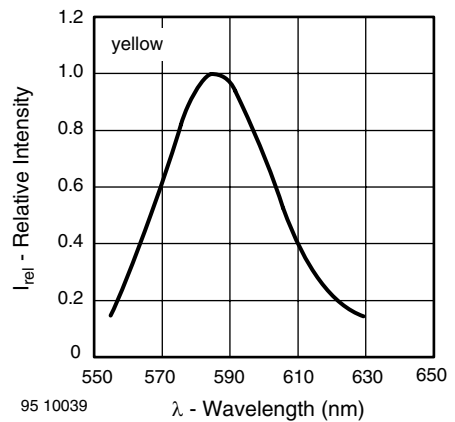

Fig. 12 - Relative Intensity vs. Wavelength



Fig. 13 - Forward Current vs. Forward Voltage



Fig. 16 - Relative Luminous Intensity vs. Forward Current



Fig. 14 - Rel. Luminous Intensity vs. Ambient Temperature

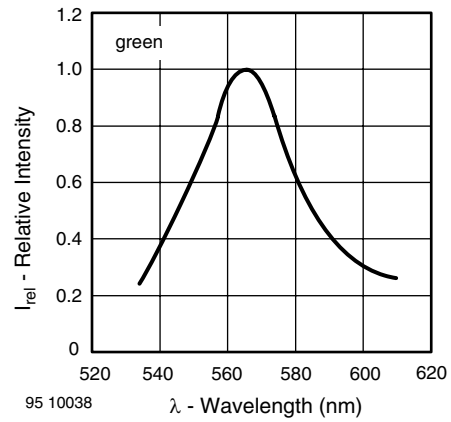

Fig. 17 - Relative Intensity vs. Wavelength



Fig. 15 - Specific Luminous Intensity vs. Forward Current

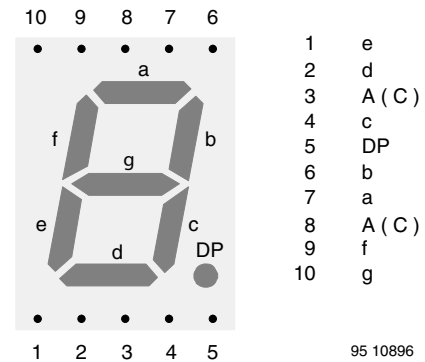

Fig. 18 - TDS.51..



TDSG5150, TDSG5160, TDSO5150, TDSO5160, TDSY5150, TDSY5160

Standard 7-Segment Display 13 mm Vishay Semiconductors

PACKAGE DIMENSIONS FOR TDS.51.. in millimeters



Drawing-No.: 6.544-5150.01-4
Issue: 1; 21.11.95
95 11344

Display-13 mm

Package Dimensions in mm

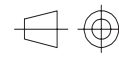
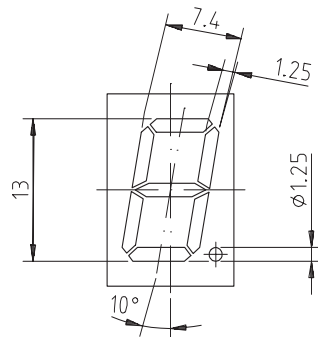
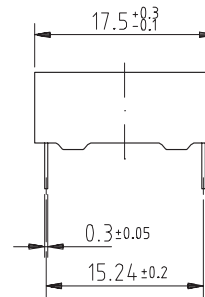
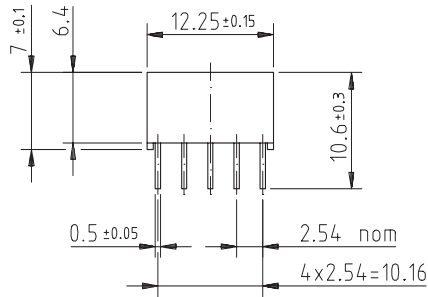

technical drawings
according to DIN
specifications

95 11344

Ozone Depleting Substances Policy Statement

It is the policy of **Vishay Semiconductor GmbH** to

1. Meet all present and future national and international statutory requirements.
2. Regularly and continuously improve the performance of our products, processes, distribution and operating systems with respect to their impact on the health and safety of our employees and the public, as well as their impact on the environment.

It is particular concern to control or eliminate releases of those substances into the atmosphere which are known as ozone depleting substances (ODSs).

The Montreal Protocol (1987) and its London Amendments (1990) intend to severely restrict the use of ODSs and forbid their use within the next ten years. Various national and international initiatives are pressing for an earlier ban on these substances.

Vishay Semiconductor GmbH has been able to use its policy of continuous improvements to eliminate the use of ODSs listed in the following documents.

1. Annex A, B and list of transitional substances of the Montreal Protocol and the London Amendments respectively
2. Class I and II ozone depleting substances in the Clean Air Act Amendments of 1990 by the Environmental Protection Agency (EPA) in the USA
3. Council Decision 88/540/EEC and 91/690/EEC Annex A, B and C (transitional substances) respectively.

Vishay Semiconductor GmbH can certify that our semiconductors are not manufactured with ozone depleting substances and do not contain such substances.

**We reserve the right to make changes to improve technical design
and may do so without further notice.**

Parameters can vary in different applications. All operating parameters must be validated for each customer application by the customer. Should the buyer use Vishay Semiconductors products for any unintended or unauthorized application, the buyer shall indemnify Vishay Semiconductors against all claims, costs, damages, and expenses, arising out of, directly or indirectly, any claim of personal damage, injury or death associated with such unintended or unauthorized use.

Vishay Semiconductor GmbH, P.O.B. 3535, D-74025 Heilbronn, Germany
Telephone: 49 (0)7131 67 2831, Fax number: 49 (0)7131 67 2423

Pin Connections 13 mm



Ozone Depleting Substances Policy Statement

It is the policy of **Vishay Semiconductor GmbH** to

1. Meet all present and future national and international statutory requirements.
2. Regularly and continuously improve the performance of our products, processes, distribution and operating systems with respect to their impact on the health and safety of our employees and the public, as well as their impact on the environment.

It is particular concern to control or eliminate releases of those substances into the atmosphere which are known as ozone depleting substances (ODSs).

The Montreal Protocol (1987) and its London Amendments (1990) intend to severely restrict the use of ODSs and forbid their use within the next ten years. Various national and international initiatives are pressing for an earlier ban on these substances.

Vishay Semiconductor GmbH has been able to use its policy of continuous improvements to eliminate the use of ODSs listed in the following documents.

1. Annex A, B and list of transitional substances of the Montreal Protocol and the London Amendments respectively
2. Class I and II ozone depleting substances in the Clean Air Act Amendments of 1990 by the Environmental Protection Agency (EPA) in the USA
3. Council Decision 88/540/EEC and 91/690/EEC Annex A, B and C (transitional substances) respectively.

Vishay Semiconductor GmbH can certify that our semiconductors are not manufactured with ozone depleting substances and do not contain such substances.

**We reserve the right to make changes to improve technical design
and may do so without further notice.**

Parameters can vary in different applications. All operating parameters must be validated for each customer application by the customer. Should the buyer use Vishay Semiconductors products for any unintended or unauthorized application, the buyer shall indemnify Vishay Semiconductors against all claims, costs, damages, and expenses, arising out of, directly or indirectly, any claim of personal damage, injury or death associated with such unintended or unauthorized use.

Vishay Semiconductor GmbH, P.O.B. 3535, D-74025 Heilbronn, Germany
Telephone: 49 (0)7131 67 2831, Fax number: 49 (0)7131 67 2423



Disclaimer

ALL PRODUCT, PRODUCT SPECIFICATIONS AND DATA ARE SUBJECT TO CHANGE WITHOUT NOTICE TO IMPROVE RELIABILITY, FUNCTION OR DESIGN OR OTHERWISE.

Vishay Intertechnology, Inc., its affiliates, agents, and employees, and all persons acting on its or their behalf (collectively, "Vishay"), disclaim any and all liability for any errors, inaccuracies or incompleteness contained in any datasheet or in any other disclosure relating to any product.

Vishay makes no warranty, representation or guarantee regarding the suitability of the products for any particular purpose or the continuing production of any product. To the maximum extent permitted by applicable law, Vishay disclaims (i) any and all liability arising out of the application or use of any product, (ii) any and all liability, including without limitation special, consequential or incidental damages, and (iii) any and all implied warranties, including warranties of fitness for particular purpose, non-infringement and merchantability.

Statements regarding the suitability of products for certain types of applications are based on Vishay's knowledge of typical requirements that are often placed on Vishay products in generic applications. Such statements are not binding statements about the suitability of products for a particular application. It is the customer's responsibility to validate that a particular product with the properties described in the product specification is suitable for use in a particular application. Parameters provided in datasheets and/or specifications may vary in different applications and performance may vary over time. All operating parameters, including typical parameters, must be validated for each customer application by the customer's technical experts. Product specifications do not expand or otherwise modify Vishay's terms and conditions of purchase, including but not limited to the warranty expressed therein.

Except as expressly indicated in writing, Vishay products are not designed for use in medical, life-saving, or life-sustaining applications or for any other application in which the failure of the Vishay product could result in personal injury or death. Customers using or selling Vishay products not expressly indicated for use in such applications do so at their own risk and agree to fully indemnify and hold Vishay and its distributors harmless from and against any and all claims, liabilities, expenses and damages arising or resulting in connection with such use or sale, including attorneys fees, even if such claim alleges that Vishay or its distributor was negligent regarding the design or manufacture of the part. Please contact authorized Vishay personnel to obtain written terms and conditions regarding products designed for such applications.

No license, express or implied, by estoppel or otherwise, to any intellectual property rights is granted by this document or by any conduct of Vishay. Product names and markings noted herein may be trademarks of their respective owners.

Данный компонент на территории Российской Федерации

Вы можете приобрести в компании MosChip.

Для оперативного оформления запроса Вам необходимо перейти по данной ссылке:

<http://moschip.ru/get-element>

Вы можете разместить у нас заказ для любого Вашего проекта, будь то серийное производство или разработка единичного прибора.

В нашем ассортименте представлены ведущие мировые производители активных и пассивных электронных компонентов.

Нашей специализацией является поставка электронной компонентной базы двойного назначения, продукции таких производителей как XILINX, Intel (ex.ALTERA), Vicor, Microchip, Texas Instruments, Analog Devices, Mini-Circuits, Amphenol, Glenair.

Сотрудничество с глобальными дистрибьюторами электронных компонентов, предоставляет возможность заказывать и получать с международных складов практически любой перечень компонентов в оптимальные для Вас сроки.

На всех этапах разработки и производства наши партнеры могут получить квалифицированную поддержку опытных инженеров.

Система менеджмента качества компании отвечает требованиям в соответствии с ГОСТ Р ИСО 9001, ГОСТ РВ 0015-002 и ЭС РД 009

Офис по работе с юридическими лицами:

105318, г.Москва, ул.Щербаковская д.3, офис 1107, 1118, ДЦ «Щербаковский»

Телефон: +7 495 668-12-70 (многоканальный)

Факс: +7 495 668-12-70 (доб.304)

E-mail: info@moschip.ru

Skype отдела продаж:

moschip.ru

moschip.ru_4

moschip.ru_6

moschip.ru_9