

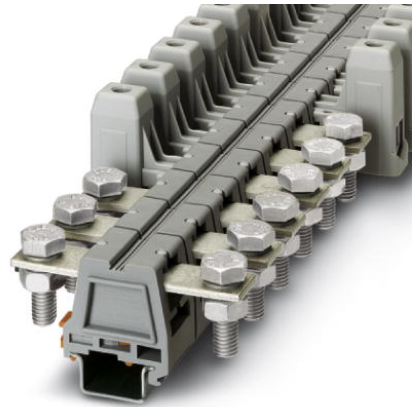

UHV 50-KH/AS

Order No.: 2130114

The illustration shows a combination of versions UHV 50-AS/AS, UHV 50-KH/
AS and UHV 50-KH/KH<http://eshop.phoenixcontact.de/phoenix/treeViewClick.do?UID=2130114>Universal terminal block with mixed connection, cross section: 25 - 50
mm², AWG: 6 - 1/0, width: 32 mm, color: gray

Commercial data

GTIN (EAN)	 4 017918 052898
sales group	A005
Pack	10 pcs.
Customs tariff	85369010
Catalog page information	Page 324 (CL-2009)

Product notes

WEEE/RoHS-compliant since:
02/08/2006

[http://
www.download.phoenixcontact.com](http://www.download.phoenixcontact.com)
Please note that the data given
here has been taken from the
online catalog. For comprehensive
information and data, please refer
to the user documentation. The
General Terms and Conditions of
Use apply to Internet downloads.

Technical data

General

Number of levels	1
Number of connections	2
Color	gray
Insulating material	PA-F
Inflammability class acc. to UL 94	HB

Dimensions

Length	104 mm
Width	32 mm
Height NS 35/15	78 mm

Technical data

Rated surge voltage	8 kV
Pollution degree	3
Surge voltage category	III
Insulating material group	II
Connection in acc. with standard	IEC 60947-7-1
Nominal current I_N	150 A
Nominal voltage U_N	1000 V

Connection data

Conductor cross section solid min.	16 mm ²
Conductor cross section solid max.	50 mm ²
Conductor cross section stranded min.	25 mm ²
Conductor cross section stranded max.	50 mm ²
Conductor cross section AWG/kcmil min.	6
Conductor cross section AWG/kcmil max	1/0
Conductor cross section stranded, with ferrule without plastic sleeve min.	25 mm ²
Conductor cross section stranded, with ferrule without plastic sleeve max.	50 mm ²
Conductor cross section stranded, with ferrule with plastic sleeve min.	25 mm ²
Conductor cross section stranded, with ferrule with plastic sleeve max.	50 mm ²
2 conductors with same cross section, solid min.	10 mm ²
2 conductors with same cross section, solid max.	16 mm ²
2 conductors with same cross section, stranded min.	10 mm ²
2 conductors with same cross section, stranded max.	16 mm ²
2 conductors with same cross section, stranded, ferrules without plastic sleeve, min.	10 mm ²
2 conductors with same cross section, stranded, ferrules without plastic sleeve, max.	16 mm ²

Type of connection	Special and hybrid connection
Stripping length	26 mm
Screw thread	M6
Bolt diameter	10 mm
Tightening torque, min	6 Nm
Tightening torque max	8 Nm
Busbar	20 mm x 3 mm

Certificates / Approvals



Certification CSA, GL, GOST, PRS, UL

Accessories

Item	Designation	Description
Assembly		
1201659	E/AL-NS 32	End clamp, for end support of UKH 50 - UKH 240, is pushed onto DIN rail NS 32 and fixed with 2 screws, width: 10 mm, color: Aluminum
1201662	E/AL-NS 35	End clamp, for end support of UKH 50 to UKH 240, is pushed onto DIN rail NS 35 and fixed with 2 screws, width: 10 mm, color: aluminum
1201028	NS 32 AL UNPERF 2000MM	G rail 32 mm (NS 32)
1201280	NS 32 CU/120QMM UNPERF 2000MM	G-profile DIN rail, deep-drawn, material: Copper, unperforated, height 15 mm, width 32 mm, length 2 m
1201358	NS 32 CU/35QMM UNPERF 2000MM	G-profile DIN rail, material: Copper, unperforated, height 15 mm, width 32 mm, length 2 m
1201002	NS 32 PERF 2000MM	G-profile DIN rail, material: Steel, perforated, height 15 mm, width 32 mm, length 2 m
1201015	NS 32 UNPERF 2000MM	G-profile DIN rail, material: Steel, unperforated, height 15 mm, width 32 mm, length 2 m
0801762	NS 35/ 7,5 CU UNPERF 2000MM	DIN rail, material: Copper, unperforated, height 7.5 mm, width 35 mm, length: 2 m
0801733	NS 35/ 7,5 PERF 2000MM	DIN rail, material: Steel, galvanized and passivated with a thick layer, perforated, height 7.5 mm, width 35 mm, length: 2 m

0801681	NS 35/ 7,5 UNPERF 2000MM	DIN rail, material: Steel, unperforated, height 7.5 mm, width 35 mm, length: 2 m
1201756	NS 35/15 AL UNPERF 2000MM	DIN rail, deep-drawn, high profile, unperforated, 1.5 mm thick, material: Aluminum, height 15 mm, width 35 mm, length 2 m
1201895	NS 35/15 CU UNPERF 2000MM	DIN rail, material: Copper, unperforated, 1.5 mm thick, height 15 mm, width 35 mm, length: 2 m
1201730	NS 35/15 PERF 2000MM	DIN rail, material: Steel, perforated, height 15 mm, width 35 mm, length: 2 m
1201714	NS 35/15 UNPERF 2000MM	DIN rail, material: Steel, unperforated, height 15 mm, width 35 mm, length: 2 m
1201798	NS 35/15-2,3 UNPERF 2000MM	DIN rail, material: Steel, unperforated, 2.3 mm thick, height 15 mm, width 35 mm, length: 2 m
2130428	UHV -E	End clamp, Width: 5.2 mm, Color: gray
2130402	UHV -TP1	Separating plate, Width: 2 mm, Height: 67.5 mm, Color: gray
2130444	UHV 50-AH	Covering hood, Color: gray
5030897	UHV 50-VS 2	Connection rail, Color: silver
2130622	UHV 50-VS 3	Connection rail, Color: silver

Marking

1007248	SBS10:UNBEDRUCKT	Marker cards, unprinted, for individual labeling with the M-PEN, 250-section, perforated, white plastic
1050525	ZB10:SO/CMS	Zack strip, 10-section, divisible, special printing, marking according to customer requirements

Plug/Adapter

3009228	UKH 50 EP	Insertion profile, Color: silver
---------	-----------	----------------------------------

Tools

1205082	SZS 1,2X8,0 VDE	Screwdriver, bladed, VDE insulated, size: 1.2 x 8.0 x 175 mm, 2-component grip, with non-slip grip
---------	-----------------	--

Diagrams/Drawings

Dimensioned drawing

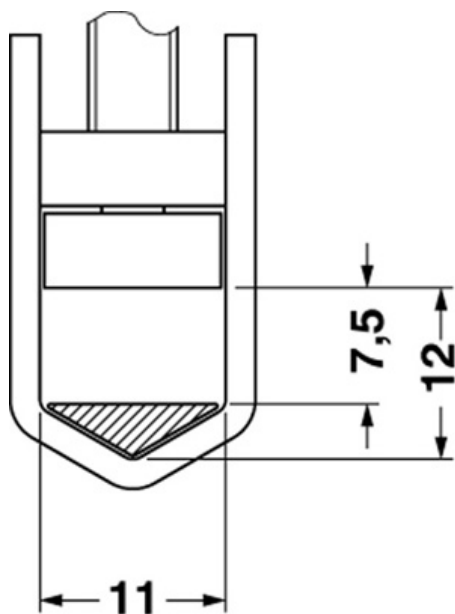
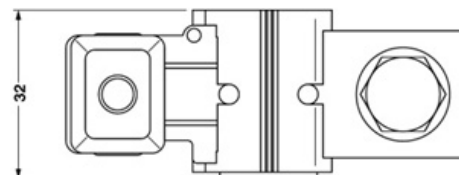
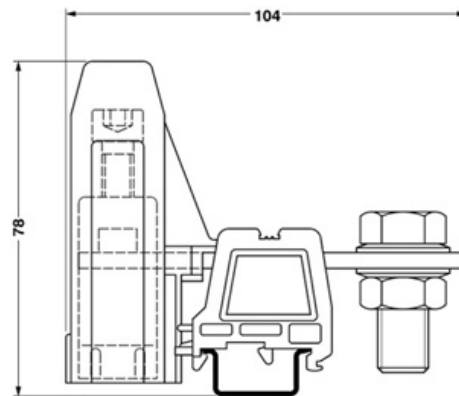
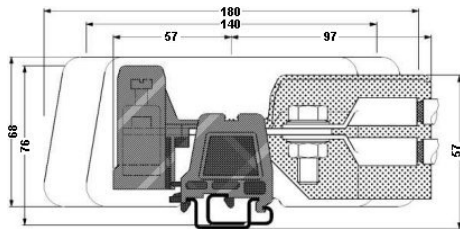

Circuit diagram

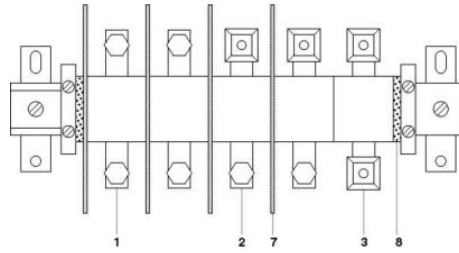

- 1 = high current connector, AS screw set on both sides
- 2 = high current connector, terminal sleeve KH on one side, screw set AS on the other side
- 3 = high current connector
- 7 = separating plate
- 8 = end piece

Address

PHOENIX CONTACT Deutschland GmbH
Flachmarktstr. 8
32825 Blomberg, Germany
Phone +49 5235 3 12000
Fax +49 5235 3 41200
<http://www.phoenixcontact.de>



© 2011 Phoenix Contact
Technical modifications reserved;

Данный компонент на территории Российской Федерации

Вы можете приобрести в компании MosChip.

Для оперативного оформления запроса Вам необходимо перейти по данной ссылке:

<http://moschip.ru/get-element>

Вы можете разместить у нас заказ для любого Вашего проекта, будь то серийное производство или разработка единичного прибора.

В нашем ассортименте представлены ведущие мировые производители активных и пассивных электронных компонентов.

Нашей специализацией является поставка электронной компонентной базы двойного назначения, продукции таких производителей как XILINX, Intel (ex.ALTERA), Vicor, Microchip, Texas Instruments, Analog Devices, Mini-Circuits, Amphenol, Glenair.

Сотрудничество с глобальными дистрибьюторами электронных компонентов, предоставляет возможность заказывать и получать с международных складов практически любой перечень компонентов в оптимальные для Вас сроки.

На всех этапах разработки и производства наши партнеры могут получить квалифицированную поддержку опытных инженеров.

Система менеджмента качества компании отвечает требованиям в соответствии с ГОСТ Р ИСО 9001, ГОСТ РВ 0015-002 и ЭС РД 009

Офис по работе с юридическими лицами:

105318, г.Москва, ул.Щербаковская д.3, офис 1107, 1118, ДЦ «Щербаковский»

Телефон: +7 495 668-12-70 (многоканальный)

Факс: +7 495 668-12-70 (доб.304)

E-mail: info@moschip.ru

Skype отдела продаж:

moschip.ru

moschip.ru_4

moschip.ru_6

moschip.ru_9