

141-200 TO 229

Technical details

Construction of illuminated pushbutton 55 and 70 mm

Three crucial advantages

Easy storage in minimum space

Every SWISSTAC switch can be altered very simply any number of times, and afterwards added to, modified or adapted. This highly modular concept means that only a few subassemblies need to be stocked, so shortening lead times, simplifying inventory control and significantly reducing storage costs

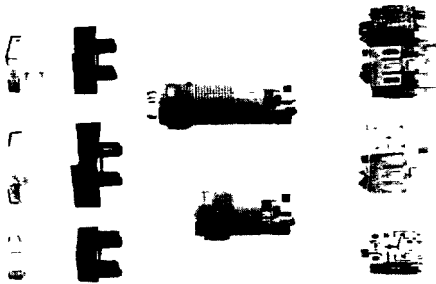

All connections on one plane

All the terminals are arranged at one level, clearly laid out and fully accessible even when in close-packed arrays. Three colours help to make wiring up easier



Ideal for switch interlock systems

SWISSTAC switches can be mechanically combined in many ways to form switch interlock systems in rows of up to 20 switches. So complicated protective and relay interlocks are unnecessary. Individual and irregular spacings between the switches of an array are no problem either.



Front section

Lens in two parts for engraving, printing or foil insert

Lens top
Foil insert (optional)
Lens holder

Side guard

Interchangeable bezel, grey or black.
Shape: \varnothing 18 mm, 18 x 18 mm, 18 x 24 mm, \varnothing 24 mm or 24 x 24 mm

Switch body

Switch body with switch mechanism and lampholder, latter available in two versions:

- T 5,5, max. 1,2 W
- Midget grooved T 1 3/4 max. 1,2 W

Connector

Location strip (optional)

Fixing nut

Spring and retaining pin, moved to change from latch to pulse mode.

Access for mechanical interlocks and trips.

Lamp terminal

Terminal block

Block equipped with 1 to 5 contact elements, fixed onto switch body when delivered. Easy to remove for wiring up.

Holder for contact elements
Lamp contact
Contact slider
Contact element (1NC + 1NO contact or changeover), diode unit or dummy element
Terminals, inner (NC)
Terminals, outer (NO)

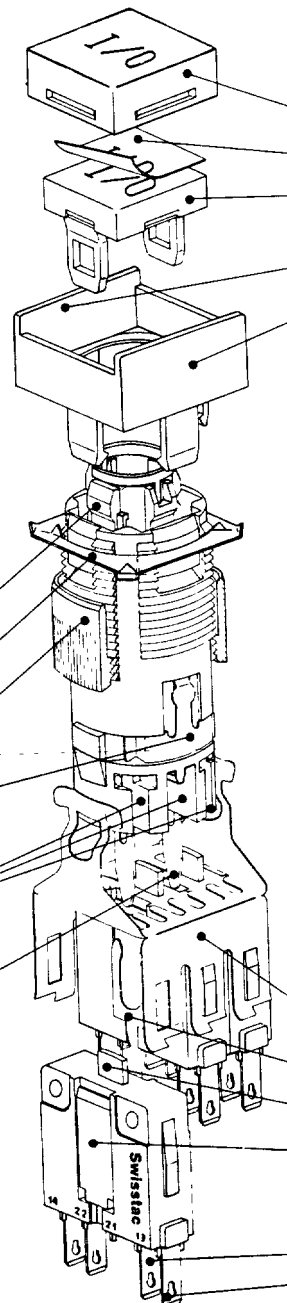

Technical details

General

SWISSTAC switches are of modular construction and made up of the three subassemblies.

- Front section: Man/switch interface and status indicator
- Intermediate section: Latching/pulse facility, lampholder, latch function select
- Terminal block: For up to five contact elements

Every switch is tested after assembly. Electrical performance and useful life are governed by the contact element. Front and intermediate section are designed for the maximum useful life of the contact element. These determine the manner of protecting the switch against outside influences. Approvals apply to complete switches. The codes of approval are UL 1054, VDE 0630, SEV 1005/CEE 24, CSA 22 2

Vibration resistance: tested to IEC 68-2-6 (10 g to 2000 Hz)

Impact resistance: tested to IEC 68-2-27 (halfsine, 50 g for 11 ms)

Approved by: UL, CSA, VDE, SEV, NEMKO, DEMKO, SEMKO, FEMKO

Front section

The front section displays the switching status, is used to operate the switch, and determines its class of protection. The shape and colours of the front section also distinguish the appearance of the whole switch. Except for the 18 mm dia. front section of illuminated pushbuttons 55 and 70 mm, all bezels have a side guard against accidental operation.

Materials	Lens	Thermoplastic (PC)
	Bezel	Thermoplastic, fire-resistant (PBT)
	Actuator 35 mm	Thermoplastic, fire-resistant (PBT)
	Lock housing	Thermoplastic, fire-resistant (PBT)
	Lock cylinder	Rynite with carbon fibre reinforcement (PBT + CF)
	Sealing gland (IP 65)	Silicone

Protection class to IEC 529

IP 40
IP 65
IP 67

Protection against water
0 = no protection
5 = splash-proof
7 = immersible to 1 m w.g.

Protection against foreign bodies
4 = protection against solid bodies > Ø 1 mm
6 = dustproof

Other properties under **Intermediate section** below

Intermediate section

The intermediate section performs a number of functions such as pulse and latching. In addition, all components making up a complete switch are attached to the intermediate section. These are the front section, terminal block and lamps.

Materials	Housing	Thermoplastic, fire-resistant (PC)
	Lamp contact	German silver 2,8 x 0,5 mm
Electrical	Dielectric strength	2000 V AC, 50 Hz, 1 min to IEC 512-2-11
	Insulation resistance	>10 ¹² ohm to IEC 512-2-10
	Lamp voltage	6 V to 220 V to SEV, NEMKO, FEMKO 6 V to 125 V to CSA 6 V to 60 V to VDE, UL, DEMKO 6 V to 50 V to SEMKO
	Lamp power	1,2 W max.
Thermal	Operating temperature	- 25°C to + 55°C
	Storage temperature	- 40°C to + 85°C
Mechanical	Useful life	> 2 x 10 ⁶ operations for illuminated pushbuttons > 5 x 10 ⁴ operations for key-, lever- and emergency Stop switches > 2,5 x 10 ⁵ operations for push/pull illuminated switch

Terminal block

The terminal block contains up to five mutually independent contact elements as switching elements. The switch's load capacity is determined solely by the contact elements fitted. There are five different kinds of contact elements:

1. Standard contact element
2. Contact element for uprated switching frequency
3. Emergency Stop element
4. Diode or twin-diode element
5. Dummy element

The data immediately below apply to all elements. Data specific to the different elements are shown overleaf

Materials	Holder for three contact elements Holder for two contact elements Lamp contact	Stainless chrome steel Thermoplastic, fire-resistant (PA6) CuBe, 2 µm Optalloy 2,8 x 0,5 mm
Electrical	Dielectric strength Insulation resistance Contact resistance Contact loading max.	2000 V AC, 50 Hz, 1 min to IEC 512-2-11 > 10 ¹² ohm < = 50 milliohm typical, new static AC: 250 V/6 A (VDE 5 A), cos φ = 0,7 - 0,8 DC: 250 V/0,5 A DC: 110 V/2 A DC: 75 V/5 A
Caution!	For thermal reasons, 4 and 5-pole terminal block is limited to $I_{max} = 4$ A With flat connectors, VDE 0630 and SEV standards specify use of insulating sleeve No. 280-0010-00.	
Thermal	Operating temperature Storage temperature Continuous current $I_{th max}$	- 25°C to + 55°C - 40°C to + 85°C 6 A, up to 3-pole terminal block 4 A, with 4 and 5-pole terminal blocks
Mechanical	Useful life Contact gap Contact cleaning path Bounce time Operating force Weight	2 million operations 2 x 0,65 mm, emerg Stop element > 2 x 1,5 mm 2 x 0,6 mm 0,5 ms typical 2 N approx. per contact element 3 g approx.

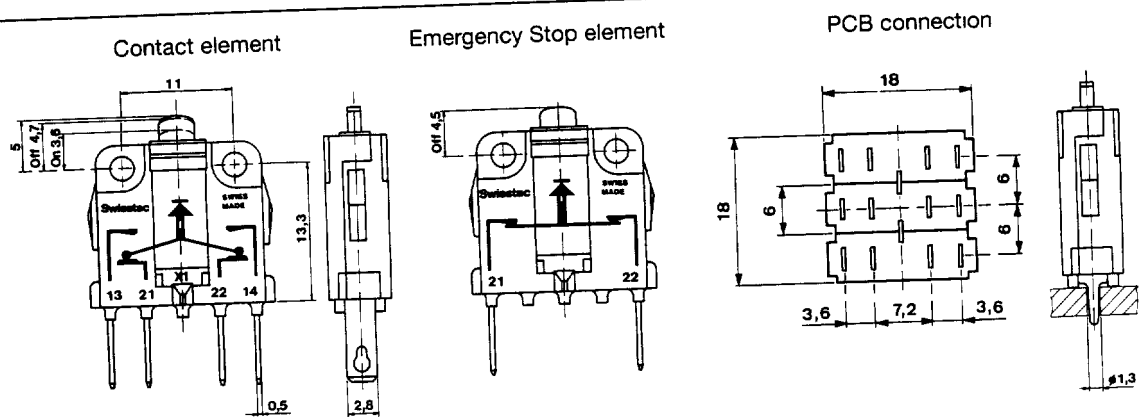

Technical details

Standard contact element

These have duplicate snap breaking contacts. The long cleaning path ensures excellent self-cleaning. The multi-coated contacts are intended for general-purpose use. The top coat is 2 µm of gold. Each contact element consists of a normally closed (NC) contact and a normally open (NO) contact. They are designed for normal switching frequency to VDE 0630.

Materials	Housing	Thermoplastic (PETP) fire-resistant to UL 94 V0
	Contact	AgNi, 2 µm gold-plated
	Contact holder	Brass or CuBe
	Terminal	Gold-plated brass 2,8 x 0,5 mm solder and plug terminal combined or PCB connector max cross-section 1 mm ²

Useful life	Full load	> 10 ⁴ load cycles
	Reduced load	> 2 x 10 ⁶ load cycles

Identification XXX ⊖

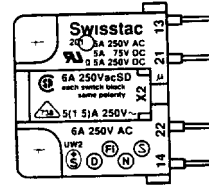

Contact element for uprated switching frequency

These have two snap breaking contacts. The long cleaning path ensures excellent self-cleaning. The multi-coated contacts are intended for general-purpose use. The top coat is 2 µm of gold. Each contact element consists of a normally closed (NC) contact and a normally open (NO) contact. The units are designed for uprated switching frequency to VDE 0630.

Materials	Housing	Duroplast (DAP) fire-resistant to UL 94 V0
	Contact	AgNi, 2 µm gold-plated
	Contact holder	Brass or CuBe
	Terminal	Gold-plated brass 2,8 x 0,5 mm solder and plug terminal combined or PCB connector max cross-section 1 mm ²

Useful life	Full load	> 5 x 10 ⁴ load cycles
	Reduced load	> 2 x 10 ⁶ load cycles

Identification XXX ⊕
⊕ sign nearest to VDE-approval

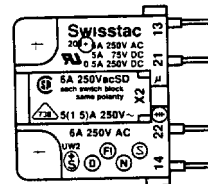

Emergency Stop element

These have a rigid contact bridge. This has a positive opening action and consists of a normally closed (NC) contact only. The multi-coated contacts are intended for general-purpose use and are finished with 2 µm of gold. The emergency Stop element is designed for uprated switching frequency to VDE 0630.

Materials	Housing	Duroplast (DAP) fire-resistant to UL 94 V0
	Contact	AgNi, 2 µm gold-plated
	Contact holder	Brass or CuBe
	Terminal	Gold-plated brass 2,8 x 0,5 mm solder and plug terminal combined or PCB connector max cross-section 1 mm ²



Useful life	Full load	> 5 x 10 ⁴ load cycles
	Reduced load	> 2 x 10 ⁶ load cycles









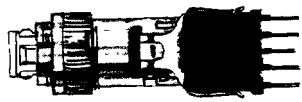











Technical details

Diode and twin-diode element	performs no switching function. The diodes are soldered in the element housing between the terminals.		
	Materials	Housing	Thermoplastic (PETP) fire-resistant to UL 94 V0
		Terminal	Gold-plated brass 2,8 x 0,5 mm solder and plug terminal combined or PCB connector max cross-section 1 mm ²
		Diode	1 N/4007, $I_{max} = 1 \text{ A}$, $U_{block} = 1000 \text{ V}$
Dummy element	is inserted at otherwise vacant places in the terminal block. Dummy elements have no metal parts and no electrical function		
	Materials	Housing	Thermoplastic (PBT) fire-resistant to UL 94 V0

Illuminated pushbutton 55-70 mm

IP 40

Consisting of:			
Diagram	Connection	Lampholder	Part No.
			Mounting depth mm
			Drilling plan No
			Dimension drawing No

Illuminated pushbutton latch mode (convertible to pulse mode)							
	1 NC + 1 NO	s/p	MG T 1 3/4	901- 000-00	55	B 1 ¹⁾	M 1
	2 NC + 2 NO	s/p	MG T 1 3/4	902- .000-00	55	B 1 ¹⁾	M 1
	3 NC + 3 NO	s/p	MG T 1 3/4	903- .000-00	55	B 1 ¹⁾	M 1
	4 NC + 4 NO	s/p	MG T 1 3/4	904- .000-00	55	B 1 ¹⁾	M 1
	5 NC + 5 NO	s/p	MG T 1 3/4	905- .000-00	55	B 1 ¹⁾	M 1
	1 NC + 1 NO	pcb	MG T 1 3/4	901- .000-0P	52	B 1 ¹⁾	M 11
	2 NC + 2 NO	pcb	MG T 1 3/4	902- .000-0P	52	B 1 ¹⁾	M 11
	3 NC + 3 NO	pcb	MG T 1 3/4	903- .000-0P	52	B 1 ¹⁾	M 11
	4 NC + 4 NO	pcb	MG T 1 3/4	904- .000-0P	52	B 1 ¹⁾	M 11
	5 NC + 5 NO	pcb	MG T 1 3/4	905- .000-0P	52	B 1 ¹⁾	M 11
	1 NC + 1 NO	s/p	T 5.5	801- .000-00	70	B 1 ¹⁾	M 1
	2 NC + 2 NO	s/p	T 5.5	802- .000-00	70	B 1 ¹⁾	M 1
	3 NC + 3 NO	s/p	T 5.5	803- .000-00	70	B 1 ¹⁾	M 1
	4 NC + 4 NO	s/p	T 5.5	804- .000-00	70	B 1 ¹⁾	M 1
	5 NC + 5 NO	s/p	T 5.5	805- .000-00	70	B 1 ¹⁾	M 1
	1 NC + 1 NO	pcb	T 5.5	801- .000-0P	67	B 1 ¹⁾	M 11
	2 NC + 2 NO	pcb	T 5.5	802- .000-0P	67	B 1 ¹⁾	M 11
	3 NC + 3 NO	pcb	T 5.5	803- .000-0P	67	B 1 ¹⁾	M 11
	4 NC + 4 NO	pcb	T 5.5	804- .000-0P	67	B 1 ¹⁾	M 11
	5 NC + 5 NO	pcb	T 5.5	805- .000-0P	67	B 1 ¹⁾	M 11

Key: s/p = solder and plug-on terminal combined NC = normally closed contact
 pcb = printed circuit board terminal NO = normally open contact
 X1 = anode lamp terminal
 MG = midjet grooved
¹⁾ IP 65 bezels require drilling plan B 2

Ordering example: Illuminated pushbutton 901- 000-00 (see following note)
 Bezel 200-6000-00
 Lens 200-5170-00

Note: For **updated switching frequency**, order the appropriate switch by replacing the first dash in the Part No. with a +. Example: 901+ .000-00

Lamps: Incandescent bulbs, glowlamps and LEDs must be ordered separately (see section 13 "Accessories")

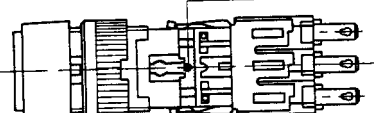
Pulse mode:  To convert the illuminated pushbutton to pulse mode, remove the spring and take out the retaining pin underneath.

Illuminated pushbutton 55-70 mm

IP 40

Type	Colour	Part No	Part No	Part No.	Part No.	Part No.
------	--------	---------	---------	----------	----------	----------



Bezel



Ø 18 mm



18 x 18 mm



18 x 24 mm



Ø 24 mm



24 x 24 mm

grey
black

200-1000-00
200-2000-00

200-3000-00
200-4000-00

200-5000-00
200-6000-00

200-7000-00
200-8000-00

200-9000-00
200-0000-00

Flush-mounted bezel
incl fixing bracket

The mounting
depth is increased
by 7 mm
Dim drawing M14
Drilling plan B3



18 x 24 mm

grey
black

200-5000-V0
200-6000-V0



Lens



Ø 18 mm



18 x 18 mm



18 x 24 mm



Ø 24 mm



24 x 24 mm

Translucent

orange
red
green
blue
white
yellow
¹⁾ grey
¹⁾ black

200-1110-00
200-1120-00
200-1140-00
200-1150-00
200-1160-00
200-1170-00
200-1180-00
200-1190-00

200-3110-00
200-3120-00
200-3140-00
200-3150-00
200-3160-00
200-3170-00
200-3180-00
200-3190-00

200-5110-00
200-5120-00
200-5140-00
200-5150-00
200-5160-00
200-5170-00
200-5180-00
200-5190-00

200-7110-00
200-7120-00
200-7140-00
200-7150-00
200-7160-00
200-7170-00
200-7180-00
200-7190-00

200-9110-00
200-9120-00
200-9140-00
200-9150-00
200-9160-00
200-9170-00
200-9180-00
200-9190-00

Transparent
(recommended for
glowlamps and LEDs)

orange
red
green
blue
white
yellow

200-1210-00
200-1220-00
200-1240-00
200-1250-00
200-1260-00
200-1270-00

200-3210-00
200-3220-00
200-3240-00
200-3250-00
200-3260-00
200-3270-00

200-5210-00
200-5220-00
200-5240-00
200-5250-00
200-5260-00
200-5270-00

200-7210-00
200-7220-00
200-7240-00
200-7250-00
200-7260-00
200-7270-00

200-9210-00
200-9220-00
200-9240-00
200-9250-00
200-9260-00
200-9270-00

Lens for flush-mounted bezel



18 x 24 mm

Transparent
(recommended for
glowlamps and LEDs)

orange
red
green
blue
white
yellow

200-5210-V0
200-5220-V0
200-5240-V0
200-5250-V0
200-5260-V0
200-5270-V0

Translucent

Diffuser for lens transparent

200-5160-V0

Key:

¹⁾ opaque

Type	Colour	Part No.	Part No.
Bezel			
	complete with sealing ring		
		Ø 24 mm	24 x 24 mm
	grey	200-7000-W0	200-9000-W0
	black	200-8000-W0	200-0000-W0
Lens			
	complete with sealing gland		
		Ø 24 mm	24 x 24 mm
Translucent	orange	200-7110-W0	200-9110-W0
	red	200-7120-W0	200-9120-W0
	green	200-7140-W0	200-9140-W0
	blue	200-7150-W0	200-9150-W0
	white	200-7160-W0	200-9160-W0
	yellow	200-7170-W0	200-9170-W0
	²⁾ grey	200-7180-W0	200-9180-W0
²⁾ black	200-7190-W0	200-9190-W0	
Transparent (recommended for glowlamps and LEDs)	orange	200-7210-W0	200-9210-W0
	red	200-7220-W0	200-9220-W0
	green	200-7240-W0	200-9240-W0
	blue	200-7250-W0	200-9250-W0
	white	200-7260-W0	200-9260-W0
	yellow	200-7270-W0	200-9270-W0
Seal			
IP 65	to fit Ø 24 mm and 24 x 24 mm		
Sealing gland		200-7009-W0	
Sealing ring			200-9009-W0

Note





The first time the button is pressed, the gland is forced into its groove and becomes effective

Key: ¹⁾ For IP 65 versions we recommend location strip No. 260-0020-00 to prevent the actuator from twisting
²⁾ opaque

141-240.



Illuminated pushbutton 55-70 mm

IP 40 and IP 65

Type	Colour	Part No	Part No.	Part No.	Part No.	Part No
Mushroom lens IP 40						
	can be used only with diameter 18 mm bezel.					
			18 x 24 mm	Ø 24 mm	24 x 24 mm	
Material opaque	red		200-5320-00	200-7320-00	200-9320-00	
	green		200-5340-00	200-7340-00	200-9340-00	
	yellow		200-5370-00	200-7370-00	200-9370-00	
	black		200-5390-00	200-7390-00	200-9390-00	

Splash proof, two parts

Membrane of PVC, protection class IP 65. Incandescent lamps can be changed from the front with no difficulty.

	
18 x 18 mm (24 x 24 mm)	18 x 24 mm (24 x 30 mm)
200-3009-W0	200-5009-W0



Flap guard

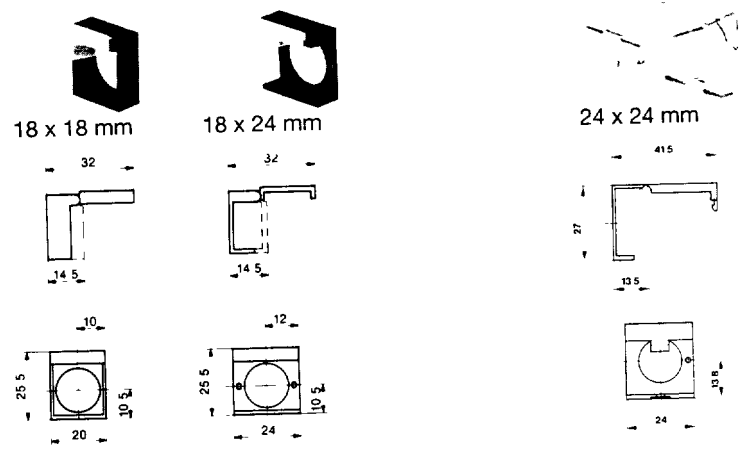



transparent, protects against accidental operation. Hinged, sealable.



for IP 40 for IP 65	200-4008-00	200-6008-00	200-9008-00 200-9008-W0
------------------------	-------------	-------------	----------------------------

Aluminium guards

for bezel sizes			
	Ø 18 mm (Ø 20 mm)	18 x 18 mm (18 x 20 mm)	18 x 24 mm (20 x 24 mm)
	200-1007-00	200-3007-00	200-5007-00

Type	Colour	Part No.	Part No.	Part No.	Part No.
Blanking plate					
IP 40					
		Ø 18 mm	18 x 18 mm	18 x 24 mm	
	grey	200-1006-00	200-3006-00	200-5006-00	
	black	200-2006-00	200-4006-00	200-6006-00	
IP 65					
		Ø 18 mm		24 x 24 mm	
	black	200-2006-W0		200-0006-W0	

Mounting instructions

The switch is mounted in a fascia/control panel in two steps:

- 1 Insert switch in fascia/control panel
- 2 Snap on bezel and tighten fixing nut

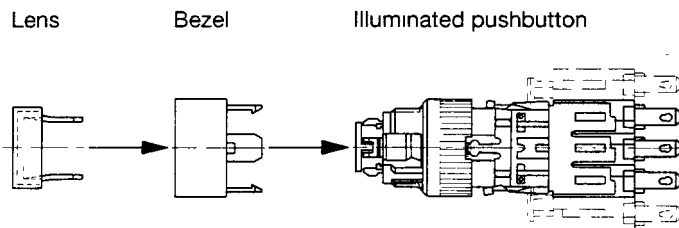

Данный компонент на территории Российской Федерации

Вы можете приобрести в компании MosChip.

Для оперативного оформления запроса Вам необходимо перейти по данной ссылке:

<http://moschip.ru/get-element>

Вы можете разместить у нас заказ для любого Вашего проекта, будь то серийное производство или разработка единичного прибора.

В нашем ассортименте представлены ведущие мировые производители активных и пассивных электронных компонентов.

Нашей специализацией является поставка электронной компонентной базы двойного назначения, продукции таких производителей как XILINX, Intel (ex.ALTERA), Vicor, Microchip, Texas Instruments, Analog Devices, Mini-Circuits, Amphenol, Glenair.

Сотрудничество с глобальными дистрибьюторами электронных компонентов, предоставляет возможность заказывать и получать с международных складов практически любой перечень компонентов в оптимальные для Вас сроки.

На всех этапах разработки и производства наши партнеры могут получить квалифицированную поддержку опытных инженеров.

Система менеджмента качества компании отвечает требованиям в соответствии с ГОСТ Р ИСО 9001, ГОСТ РВ 0015-002 и ЭС РД 009

Офис по работе с юридическими лицами:

105318, г.Москва, ул.Щербаковская д.3, офис 1107, 1118, ДЦ «Щербаковский»

Телефон: +7 495 668-12-70 (многоканальный)

Факс: +7 495 668-12-70 (доб.304)

E-mail: info@moschip.ru

Skype отдела продаж:

moschip.ru

moschip.ru_4

moschip.ru_6

moschip.ru_9