

64K x 16 LOW VOLTAGE, ULTRA LOW POWER CMOS STATIC RAM

DECEMBER 2012

FEATURES

- High-speed access time: 35ns, 45ns, 55ns
- CMOS low power operation:
 - 15 mW (typical) operating
 - 1.5 μ W (typical) CMOS standby
- TTL compatible interface levels
- Single power supply
 - 1.65V--2.2V V_{DD} (62WV6416DALL)
 - 2.3V--3.6V V_{DD} (65WV6416DBLL)
- Fully static operation: no clock or refresh required
- Three state outputs
- Data control for upper and lower bytes
- Industrial and automotive temperature support
- 2CS Option Available
- Lead-free available

DESCRIPTION

The *ISSI* IS62/65WV6416DALL and IS62/65WV6416DBLL are high-speed, 1M bit static RAMs organized as 64K words by 16 bits. It is fabricated using *ISSI*'s high-performance CMOS technology. This highly reliable process coupled with innovative circuit design techniques, yields high-performance and low power consumption devices.

When $\overline{CS1}$ is HIGH (deselected) or when CS2 is LOW (deselected) or when $\overline{CS1}$ is LOW, CS2 is HIGH and both \overline{LB} and \overline{UB} are HIGH, the device assumes a standby mode at which the power dissipation can be reduced down with CMOS input levels.

Easy memory expansion is provided by using Chip Enable and Output Enable inputs. The active LOW Write Enable (\overline{WE}) controls both writing and reading of the memory. A data byte allows Upper Byte (\overline{UB}) and Lower Byte (\overline{LB}) access.

The IS62/65WV6416DALL and IS62/65WV6416DBLL are packaged in the JEDEC standard 48-pin mini BGA (6mm x 8mm) and 44-Pin TSOP (TYPE II).

FUNCTIONAL BLOCK DIAGRAM



PIN CONFIGURATIONS

**48-Pin mini BGA (6mm x 8mm)
(Package Code B)**

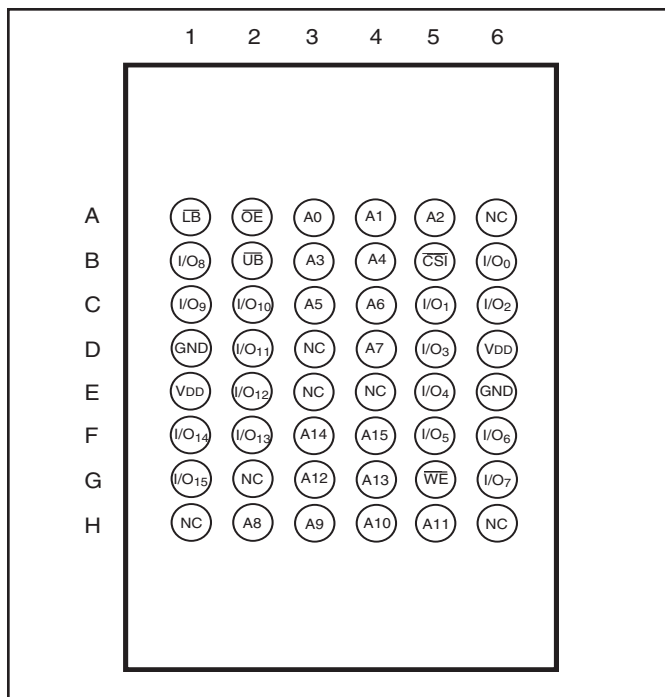

**48-Pin mini BGA (6mm x 8mm)
2 CS Option (Package Code B2)**

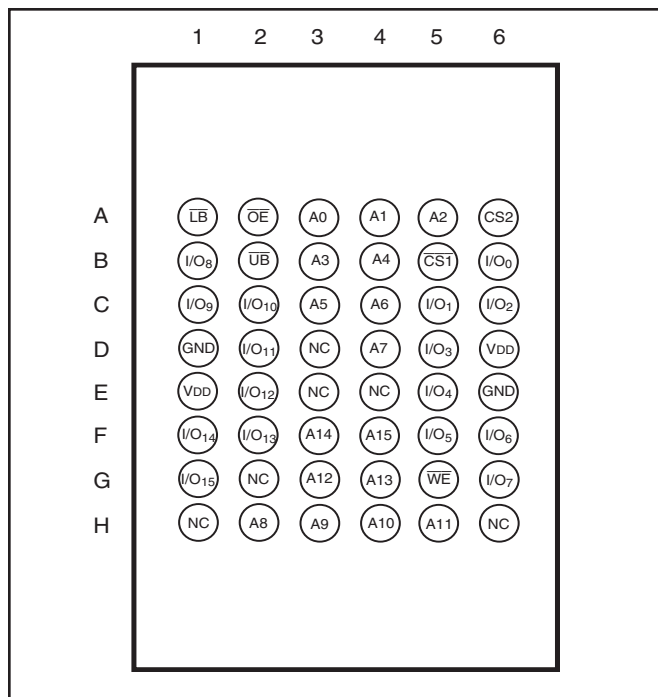

PIN DESCRIPTIONS

A0-A15	Address Inputs
I/O0-I/O15	Data Inputs/Outputs
CS1, CS2	Chip Enable Input
OE	Output Enable Input
WE	Write Enable Input
LB	Lower-byte Control (I/O0-I/O7)
UB	Upper-byte Control (I/O8-I/O15)
NC	No Connection
VDD	Power
GND	Ground

**44-Pin mini TSOP (Type II)
(Package Code T)**



TRUTH TABLE

Mode	WE	CS1	CS2	OE	LB	UB	I/O PIN		V _{DD} Current
							I/O0-I/O7	I/O8-I/O15	
Not Selected	X	H	X	X	X	X	High-Z	High-Z	ISB1, ISB2
	X	X	L	X	X	X	High-Z	High-Z	ISB1, ISB2
	X	X	X	X	H	H	High-Z	High-Z	ISB1, ISB2
Output Disabled	H	L	H	H	L	X	High-Z	High-Z	I _{CC}
	H	L	H	H	X	L	High-Z	High-Z	I _{CC}
Read	H	L	H	L	L	H	DOUT	High-Z	I _{CC}
	H	L	H	L	H	L	High-Z	DOUT	
	H	L	H	L	L	L	DOUT	DOUT	
Write	L	L	H	X	L	H	D _{IN}	High-Z	I _{CC}
	L	L	H	X	H	L	High-Z	D _{IN}	
	L	L	H	X	L	L	D _{IN}	D _{IN}	

ABSOLUTE MAXIMUM RATINGS⁽¹⁾

Symbol	Parameter	Value	Unit
V _{TERM}	Terminal Voltage with Respect to GND	-0.5 to V _{DD} + 0.5	V
V _{DD}	V _{DD} Relates to GND	-0.3 to 4.0	V
T _{STG}	Storage Temperature	-65 to +150	°C
P _T	Power Dissipation	1.0	W

Notes:

1. Stress greater than those listed under ABSOLUTE MAXIMUM RATINGS may cause permanent damage to the device. This is a stress rating only and functional operation of the device at these or any other conditions above those indicated in the operational sections of this specification is not implied. Exposure to absolute maximum rating conditions for extended periods may affect reliability.

CAPACITANCE^(1,2)

Symbol	Parameter	Conditions	Max.	Unit
C _{IN}	Input Capacitance	V _{IN} = 0V	6	pF
C _{I/O}	Input/Output Capacitance	V _{OUT} = 0V	8	pF

Notes:

1. Tested initially and after any design or process changes that may affect these parameters.
2. Test conditions: T_A = 25°C, f = 1 MHz, V_{DD} = 3.3V.

AC TEST CONDITIONS

Parameter	Unit (2.3V-3.6V)	Unit (3.3V ± 5%)	Unit (1.65V-2.2V)
Input Pulse Level	0.4V to $V_{DD} - 0.3V$	0.4V to $V_{DD} - 0.3V$	0.4V to $V_{DD} - 0.3V$
Input Rise and Fall Times	1V/ ns	1V/ ns	1V/ ns
Input and Output Timing and Reference Level (V_{Ref})	$V_{DD} / 2$	$\frac{V_{DD}}{2} + 0.05$	0.9V
Output Load	See Figures 1 and 2	See Figures 1 and 2	See Figures 1 and 2
R1 (Ω)	317	317	13500
R2 (Ω)	351	351	10800
V_{TM} (V)	3.3V	3.3V	1.8V

AC TEST LOADS



Figure 1.



Figure 2.

DC ELECTRICAL CHARACTERISTICS (Over Operating Range)

V_{DD} = 3.3V ± 5%

Symbol	Parameter	Test Conditions	Min.	Max.	Unit
V _{OH}	Output HIGH Voltage	V _{DD} = Min., I _{OH} = -1 mA	2.4	—	V
V _{OL}	Output LOW Voltage	V _{DD} = Min., I _{OL} = 2.1 mA	—	0.4	V
V _{IH}	Input HIGH Voltage		2	V _{DD} + 0.3	V
V _{IL}	Input LOW Voltage ⁽¹⁾		-0.3	0.8	V
I _{LI}	Input Leakage	GND ≤ V _{IN} ≤ V _{DD}	-1	1	μA
I _{LO}	Output Leakage	GND ≤ V _{OUT} ≤ V _{DD} , Outputs Disabled	-1	1	μA

Note:

- V_{IL} (min.) = -0.3V DC; V_{IL} (min.) = -2.0V AC (pulse width < 10 ns). Not 100% tested.
V_{IH} (max.) = V_{DD} + 0.3V DC; V_{IH} (max.) = V_{DD} + 2.0V AC (pulse width < 10 ns). Not 100% tested.

DC ELECTRICAL CHARACTERISTICS (Over Operating Range)

V_{DD} = 2.3V-3.6V

Symbol	Parameter	Test Conditions	Min.	Max.	Unit
V _{OH}	Output HIGH Voltage	V _{DD} = Min., I _{OH} = -1.0 mA	1.8	—	V
V _{OL}	Output LOW Voltage	V _{DD} = Min., I _{OL} = 2.1 mA	—	0.4	V
V _{IH}	Input HIGH Voltage		2.0	V _{DD} + 0.3	V
V _{IL}	Input LOW Voltage ⁽¹⁾		-0.3	0.8	V
I _{LI}	Input Leakage	GND ≤ V _{IN} ≤ V _{DD}	-1	1	μA
I _{LO}	Output Leakage	GND ≤ V _{OUT} ≤ V _{DD} , Outputs Disabled	-1	1	μA

Note:

- V_{IL} (min.) = -0.3V DC; V_{IL} (min.) = -2.0V AC (pulse width < 10 ns). Not 100% tested.
V_{IH} (max.) = V_{DD} + 0.3V DC; V_{IH} (max.) = V_{DD} + 2.0V AC (pulse width < 10 ns). Not 100% tested.

DC ELECTRICAL CHARACTERISTICS (Over Operating Range)

V_{DD} = 1.65V-2.2V

Symbol	Parameter	Test Conditions	V _{DD}	Min.	Max.	Unit
V _{OH}	Output HIGH Voltage	I _{OH} = -0.1 mA	1.65-2.2V	1.4	—	V
V _{OL}	Output LOW Voltage	I _{OL} = 0.1 mA	1.65-2.2V	—	0.2	V
V _{IH}	Input HIGH Voltage		1.65-2.2V	1.4	V _{DD} + 0.2	V
V _{IL} ⁽¹⁾	Input LOW Voltage		1.65-2.2V	-0.2	0.4	V
I _{LI}	Input Leakage	GND ≤ V _{IN} ≤ V _{DD}		-1	1	μA
I _{LO}	Output Leakage	GND ≤ V _{OUT} ≤ V _{DD} , Outputs Disabled		-1	1	μA

Note:

- V_{IL} (min.) = -0.3V DC; V_{IL} (min.) = -2.0V AC (pulse width < 10 ns). Not 100% tested.
V_{IH} (max.) = V_{DD} + 0.3V DC; V_{IH} (max.) = V_{DD} + 2.0V AC (pulse width < 10 ns). Not 100% tested.

OPERATING RANGE (V_{DD})

Range	Ambient Temperature	V _{DD}	Speed
Commercial	0°C to +70°C	1.65V-2.2V	45ns
Industrial	-40°C to +85°C	1.65V-2.2V	55ns
Automotive	-40°C to +125°C	1.65V-2.2V	55ns

OPERATING RANGE (V_{DD})

Range	Ambient Temperature	V _{DD} (45 ns)	V _{DD} (35 ns)
Commercial	0°C to +70°C	2.3V-3.6V	3.3V±5%
Industrial	-40°C to +85°C	2.3V-3.6V	3.3V±5%

OPERATING RANGE (V_{DD})

Range	Ambient Temperature	V _{DD} (45 ns)
Automotive	-40°C to +125°C	2.3V-3.6V

POWER SUPPLY CHARACTERISTICS⁽¹⁾ (Over Operating Range)

Symbol	Parameter	Test Conditions	-35		-45		-55		Unit	
			Min.	Max.	Min.	Max.	Min.	Max.		
I _{CC}	V _{DD} Dynamic Operating Supply Current	V _{DD} = Max.,	Com.	—	8	—	6	—	5	mA
		I _{OUT} = 0 mA, f = f _{MAX}	Ind.	—	12	—	8	—	7	
		$\overline{CE} = V_{IL}$	Auto.	—	15	—	12	—	12	
		V _{IN} ≥ V _{DD} - 0.3V, or V _{IN} ≤ 0.4V	typ. ⁽²⁾	5						
I _{CC1}	Operating Supply Current	V _{DD} = Max.,	Com.	—	2.5	—	2.5	—	2.5	mA
		I _{OUT} = 0 mA, f = 0	Ind.	—	2.5	—	2.5	—	2.5	
		$\overline{CE} = V_{IL}$	Auto.	—	5	—	5	—	5	
		V _{IN} ≥ V _{DD} - 0.3V, or V _{IN} ≤ 0.4V								
I _{SB2}	CMOS Standby Current (CMOS Inputs)	V _{DD} = Max.,	Com.	—	2	—	2	—	2	μA
		$\overline{CS1} \geq V_{DD} - 0.2V$,	Ind.	—	4	—	4	—	4	
		CS2 ≤ 0.2V,	Auto.	—	18	—	18	—	18	
		V _{IN} ≥ V _{DD} - 0.2V, or V _{IN} ≤ 0.2V, f = 0	typ. ⁽²⁾	0.6						
OR										
	ULB Control	V _{DD} = Max., $\overline{CS1} = V_{IL}$, CS2=V _{IH} V _{IN} ≤ 0.2V, f = 0; $\overline{UB} / \overline{LB} = V_{DD} - 0.2V$								

Note:

- At f = f_{MAX}, address and data inputs are cycling at the maximum frequency, f = 0 means no input lines change.
- Typical values are measured at V_{DD} = 3.0V, T_A = 25°C and not 100% tested.

READ CYCLE SWITCHING CHARACTERISTICS⁽¹⁾ (Over Operating Range)

Symbol	Parameter	35 ns		45 ns		55 ns		Unit
		Min.	Max.	Min.	Max.	Min.	Max.	
t _{RC}	Read Cycle Time	35	—	45	—	55	—	ns
t _{AA}	Address Access Time	—	35	—	45	—	55	ns
t _{OHA}	Output Hold Time	10	—	10	—	10	—	ns
t _{ACS1} /t _{ACS2}	CS1/CS2 Access Time	—	35	—	45	—	55	ns
t _{DOE}	OE Access Time	—	10	—	20	—	25	ns
t _{HZOE} ⁽²⁾	OE to High-Z Output	0	10	0	15	0	20	ns
t _{LZOE} ⁽²⁾	OE to Low-Z Output	3	—	5	—	5	—	ns
t _{HZCS1} /t _{HZCS2} ⁽²⁾	CS1/CS2 to High-Z Output	0	10	0	15	0	20	ns
t _{LZCS1} /t _{LZCS2} ⁽²⁾	CS1/CS2 to Low-Z Output	5	—	5	—	10	—	ns
t _{BA}	LB, UB Access Time	—	35	—	45	—	55	ns
t _{HZB}	LB, UB to High-Z Output	0	15	0	15	0	20	ns
t _{LZB}	LB, UB to Low-Z Output	0	—	0	—	0	—	ns

Notes:

1. Test conditions assume signal transition times of 5 ns or less, timing reference levels of 0.9V/1.5V, input pulse levels of 0.4 to V_{DD}-0.2V/V_{DD}-0.3V and output loading specified in Figure 1.
2. Tested with the load in Figure 2. Transition is measured ±500 mV from steady-state voltage. Not 100% tested.

AC WAVEFORMS

READ CYCLE NO. 1^(1,2) (Address Controlled) ($\overline{CS1} = \overline{OE} = V_{IL}$, $CS2 = \overline{WE} = V_{IH}$, \overline{UB} or $\overline{LB} = V_{IL}$)



AC WAVEFORMS

READ CYCLE NO. 2^(1,3) ($\overline{CS1}$, $CS2$, \overline{OE} , AND $\overline{UB}/\overline{LB}$ Controlled)



Notes:

1. \overline{WE} is HIGH for a Read Cycle.
2. The device is continuously selected. \overline{OE} , $\overline{CS1}$, \overline{UB} , or $\overline{LB} = V_{IL}$. $CS2 = \overline{WE} = V_{IH}$.
3. Address is valid prior to or coincident with $\overline{CS1}$ LOW transition.

WRITE CYCLE SWITCHING CHARACTERISTICS^(1,2) (Over Operating Range)

Symbol	Parameter	35 ns		45 ns		55 ns		Unit
		Min.	Max.	Min.	Max.	Min.	Max.	
t _{wc}	Write Cycle Time	45	—	45	—	55	—	ns
t _{scs1/tscs2}	CS1/CS2 to Write End	35	—	35	—	45	—	ns
t _{aw}	Address Setup Time to Write End	35	—	35	—	45	—	ns
t _{ha}	Address Hold from Write End	0	—	0	—	0	—	ns
t _{sa}	Address Setup Time	0	—	0	—	0	—	ns
t _{pwb}	LB, UB Valid to End of Write	35	—	35	—	45	—	ns
t _{pwe}	WE Pulse Width	35	—	35	—	40	—	ns
t _{sd}	Data Setup to Write End	20	—	20	—	25	—	ns
t _{hd}	Data Hold from Write End	0	—	0	—	0	—	ns
t _{hzwe} ⁽³⁾	WE LOW to High-Z Output	—	20	—	20	—	20	ns
t _{lzwe} ⁽³⁾	WE HIGH to Low-Z Output	5	—	5	—	5	—	ns

Notes:

1. Test conditions assume signal transition times of 5 ns or less, timing reference levels of 0.9V/1.5V, input pulse levels of 0.4V to V_{DD}-0.2V/V_{DD}-0.3V and output loading specified in Figure 1.
2. The internal write time is defined by the overlap of $\overline{CS1}$ LOW, CS2 HIGH and UB or LB, and \overline{WE} LOW. All signals must be in valid states to initiate a Write, but any one can go inactive to terminate the Write. The Data Input Setup and Hold timing are referenced to the rising or falling edge of the signal that terminates the write.
3. Tested with the load in Figure 2. Transition is measured ± 500 mV from steady-state voltage. Not 100% tested.

AC WAVEFORMS

WRITE CYCLE NO. 1^(1,2) ($\overline{CS1}$ Controlled, \overline{OE} = HIGH or LOW)

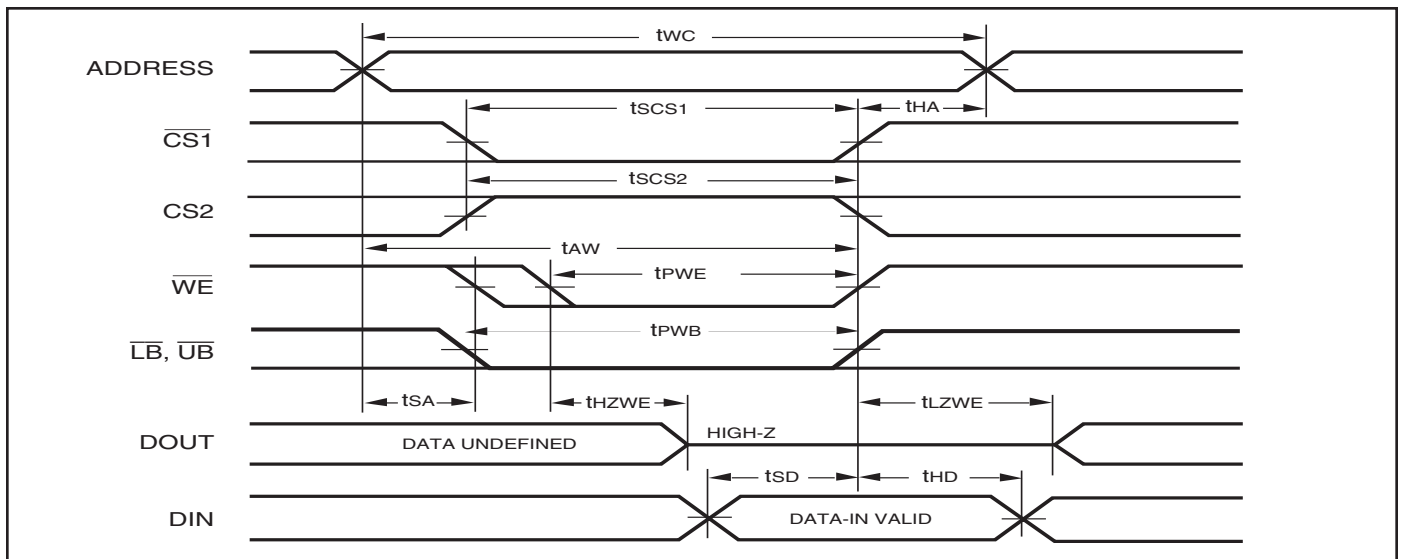

Notes:

1. WRITE is an internally generated signal asserted during an overlap of the LOW states on the $\overline{CS1}$, CS2 and \overline{WE} inputs and at least one of the LB and UB inputs being in the LOW state.
2. WRITE = ($\overline{CS1}$) [(LB) = (UB)] (\overline{WE}).

WRITE CYCLE NO. 2 (\overline{WE} Controlled: \overline{OE} is HIGH During Write Cycle)



WRITE CYCLE NO. 3 (\overline{WE} Controlled: \overline{OE} is LOW During Write Cycle)



WRITE CYCLE NO. 4 ($\overline{UB}/\overline{LB}$ Controlled)



DATA RETENTION SWITCHING CHARACTERISTICS

Symbol	Parameter	Test Condition	Min.	typ. ⁽¹⁾	Max.	Unit
V _{DR}	V _{DD} for Data Retention	See Data Retention Waveform	1.2		3.6	V
I _{DR}	Data Retention Current	V _{DD} = 1.2V, CS1 ≥ V _{DD} - 0.2V	—	0.4	2	μA
					4	
					18	
t _{SDR}	Data Retention Setup Time	See Data Retention Waveform	0		—	ns
t _{RDR}	Recovery Time	See Data Retention Waveform	t _{RC}		—	ns

Note: 1. Typical values are measured at V_{DD} = 3.0V, T_A = 25°C and not 100% tested.

DATA RETENTION WAVEFORM (CS1 Controlled)

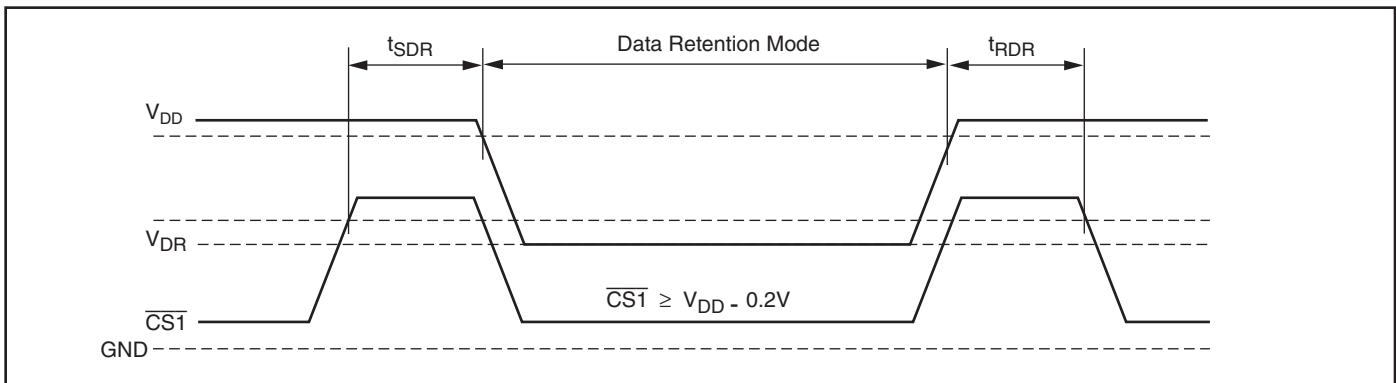

DATA RETENTION WAVEFORM (CS2 Controlled)

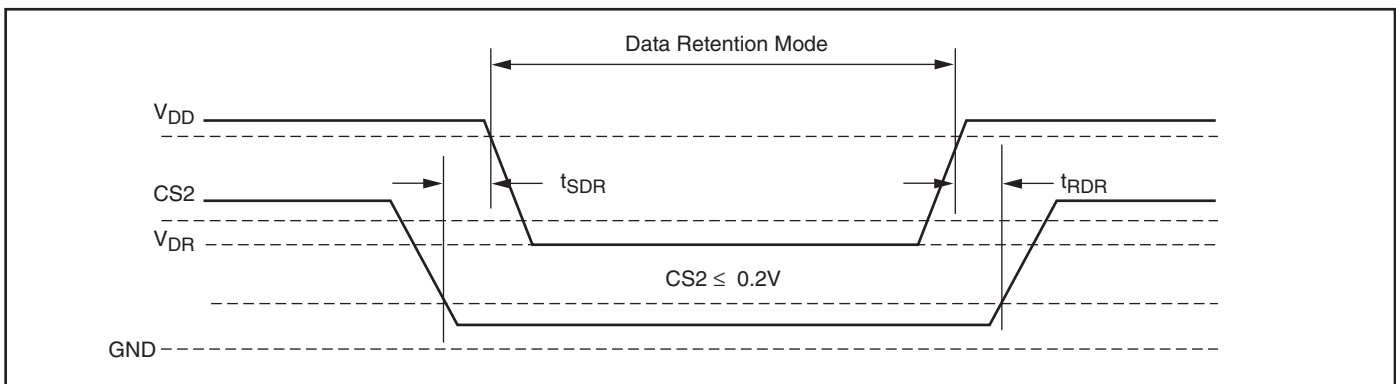

ORDERING INFORMATION

IS62WV6416DALL (1.65V - 2.2V)

Industrial Range: -40°C to +85°C

Speed (ns)	Order Part No.	Package
55	IS62WV6416DALL-55BLI	mini BGA (6mm x 8mm), Lead-free
	IS62WV6416DALL-55TLI	TSOP TYPE II, Lead-free

IS62WV6416DBLL (2.3V-3.6V)

Industrial Range: -40°C to +85°C

Speed (ns)	Order Part No.	Package
45 (35) ¹	IS62WV6416DBLL-45TI	TSOP TYPE II
	IS62WV6416DBLL-45TLI	TSOP TYPE II, Lead-free
	IS62WV6416DBLL-45BI	mini BGA (6mm x 8mm)
	IS62WV6416DBLL-45BLI	mini BGA (6mm x 8mm), Lead-free
	IS62WV6416DBLL-45B2LI	mini BGA (6mm x 8mm), 2CS, Lead-free

Note:

1. Speed = 35ns for $V_{DD} = 3.3V \pm 5\%$. Speed = 45ns for $V_{DD} = 2.3V-3.6V$

IS65WV6416DBLL (2.3V-3.6V)

Automotive Range: -40°C to +125°C

Speed (ns)	Order Part No.	Package
45	IS65WV6416DBLL-45CTLA3	TSOP TYPE II, Lead-free, Copper Lead-frame
	IS65WV6416DBLL-45BLA3	mini BGA (6mm x 8mm), Lead-free

TOP VIEW

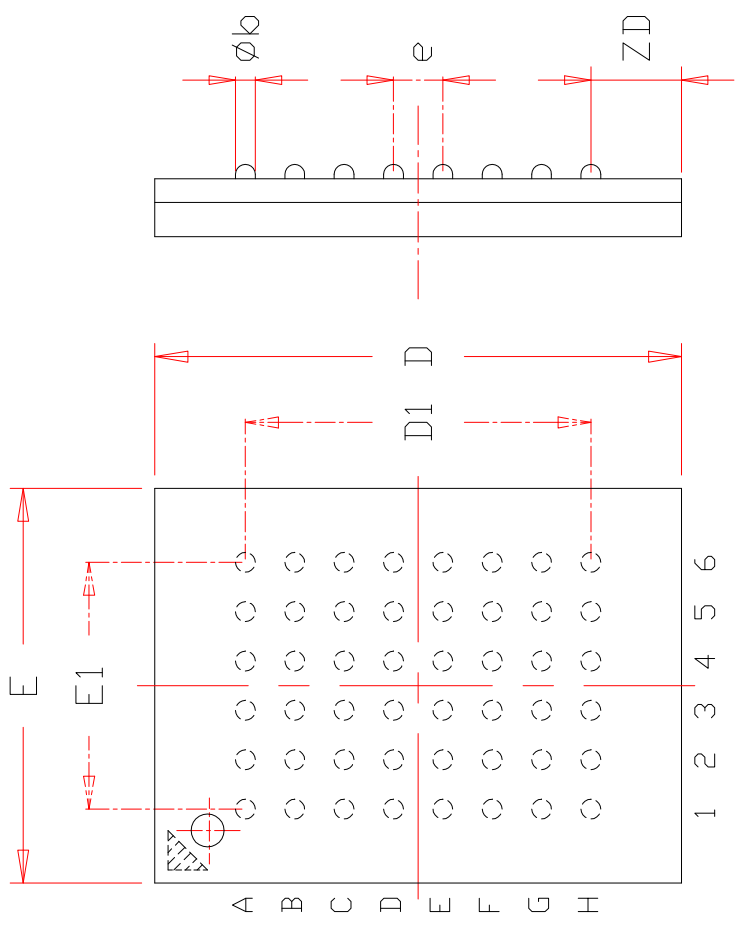

NOTE :

1. CONTROLLING DIMENSION : MM .
2. Reference document : JEDEC MO-207

SYMBOL	DIMENSION IN MM			DIMENSION IN INCH		
	MIN.	NOM.	MAX.	MIN.	NOM.	MAX.
A			1.20			0.047
A1	0.20		0.30	0.008		0.012
ϕb	0.30	0.35	0.40	0.012	0.014	0.016
D	7.90	8.00	8.10	0.311	0.315	0.319
D1		5.25 BSC			0.207 BSC	
E	5.90	6.00	6.10	0.232	0.236	0.240
E1		3.75 BSC			0.148 BSC	
e		0.75 BSC.			0.030 BSC.	
ZD		1.375 REF.			0.054 REF.	
ZE		1.125 REF.			0.044 REF.	

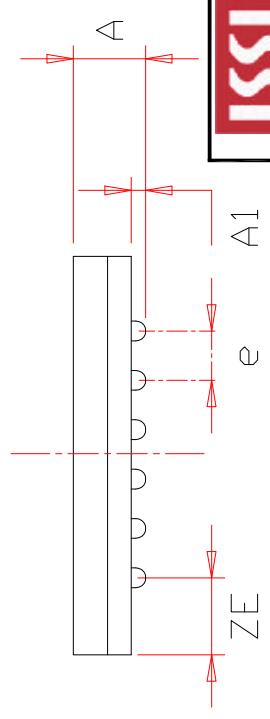

TITLE

48L 6x8mm TF-BGA
Package Outline

REV.

C

DATE

08/12/2008



Данный компонент на территории Российской Федерации

Вы можете приобрести в компании MosChip.

Для оперативного оформления запроса Вам необходимо перейти по данной ссылке:

<http://moschip.ru/get-element>

Вы можете разместить у нас заказ для любого Вашего проекта, будь то серийное производство или разработка единичного прибора.

В нашем ассортименте представлены ведущие мировые производители активных и пассивных электронных компонентов.

Нашей специализацией является поставка электронной компонентной базы двойного назначения, продукции таких производителей как XILINX, Intel (ex.ALTERA), Vicor, Microchip, Texas Instruments, Analog Devices, Mini-Circuits, Amphenol, Glenair.

Сотрудничество с глобальными дистрибьюторами электронных компонентов, предоставляет возможность заказывать и получать с международных складов практически любой перечень компонентов в оптимальные для Вас сроки.

На всех этапах разработки и производства наши партнеры могут получить квалифицированную поддержку опытных инженеров.

Система менеджмента качества компании отвечает требованиям в соответствии с ГОСТ Р ИСО 9001, ГОСТ РВ 0015-002 и ЭС РД 009

Офис по работе с юридическими лицами:

105318, г.Москва, ул.Щербаковская д.3, офис 1107, 1118, ДЦ «Щербаковский»

Телефон: +7 495 668-12-70 (многоканальный)

Факс: +7 495 668-12-70 (доб.304)

E-mail: info@moschip.ru

Skype отдела продаж:

moschip.ru

moschip.ru_4

moschip.ru_6

moschip.ru_9