

Typical Applications

The HMC572LC5 is ideal for:

- Point-to-Point and Point-to-Multi-Point Radio
- Military Radar, EW & ELINT
- Satellite Communications

Features

- 8 dB Conversion Gain
- Image Rejection: 18 dB
- 2 LO to RF Isolation: 35 dB
- Noise Figure: 3.5 dB
- Input IP3: +5 dBm
- 32 Lead 5x5mm SMT Package: 25mm²

Functional Diagram

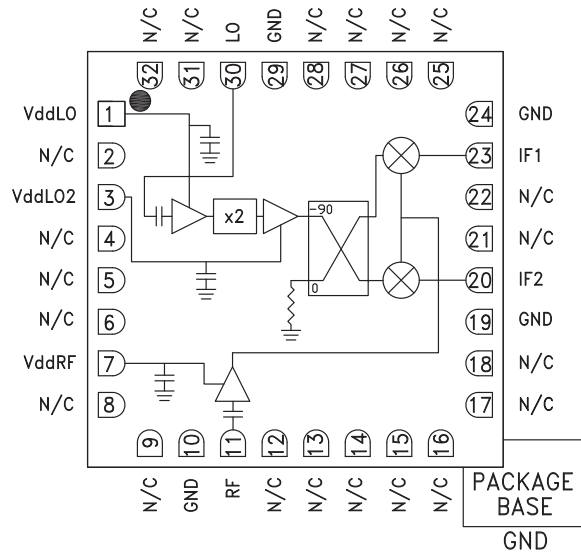

General Description

The HMC572LC5 is a compact GaAs MMIC I/Q downconverter in a leadless RoHS compliant SMT package. This device provides a small signal conversion gain of 8 dB with a noise figure of 3.5 dB and 18 dB of image rejection across the frequency band. The HMC572LC5 utilizes an LNA followed by an image reject mixer which is driven by an active x2 multiplier. The image reject mixer eliminates the need for a filter following the LNA, and removes thermal noise at the image frequency. I and Q mixer outputs are provided and an external 90° hybrid is needed to select the required sideband. The HMC572LC5 is a much smaller alternative to hybrid style image reject mixer downconverter assemblies, and it eliminates the need for wire bonding by allowing the use of surface mount manufacturing techniques.

Electrical Specifications, $T_A = +25^\circ C$, $IF = 100 MHz$, $LO = +4 dBm$, $Vdd = 3.5 Vdc^*$

Parameter	Min.	Typ.	Max.	Min.	Typ.	Max.	Units
Frequency Range, RF	24.5 - 26.5			23 - 28			GHz
Frequency Range, LO	9 - 15.5			9 - 15.5			GHz
Frequency Range, IF	DC - 3.5			DC - 3.5			GHz
Conversion Gain (As IRM)	6.0	8.0		6	10		dB
Noise Figure		3.5			3.5		dB
Image Rejection	14	17		14	20		dB
1 dB Compression (Input)	-6	-4		-7	-5		dBm
2 LO to RF Isolation	32	35		30	35		dB
2 LO to IF Isolation	30	40		25	40		dB
IP3 (Input)	+5	+8		+3	+6		dBm
Amplitude Balance		0.3			0.4		dB
Phase Balance		5			8		Deg
Total Supply Current		125	165		125	165	mA

*Data taken as IRM with external IF Hybrid

Data Taken As IRM With External IF Hybrid

Conversion Gain vs. Temperature

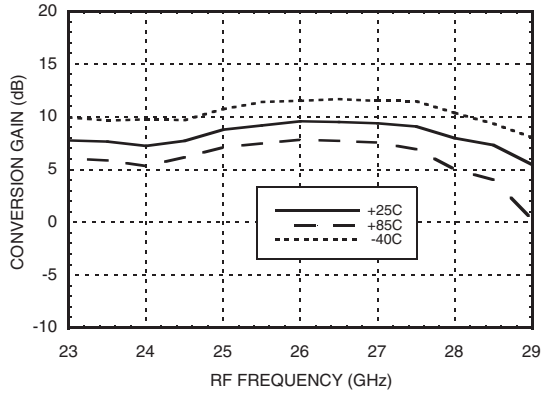
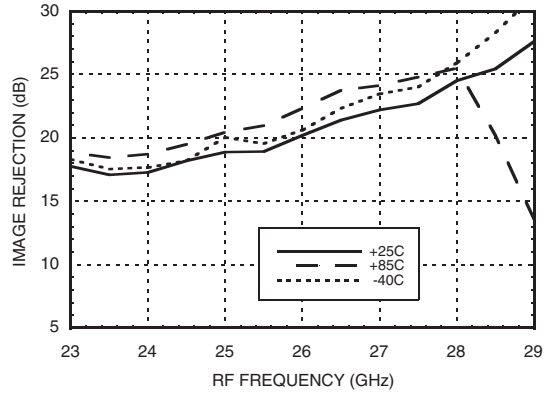
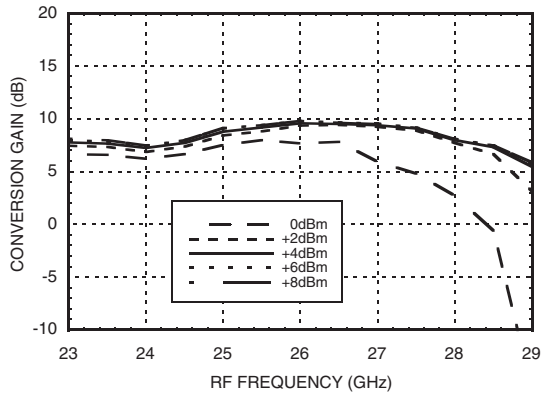

Image Rejection vs. Temperature



Conversion Gain vs. LO Drive



Return Loss

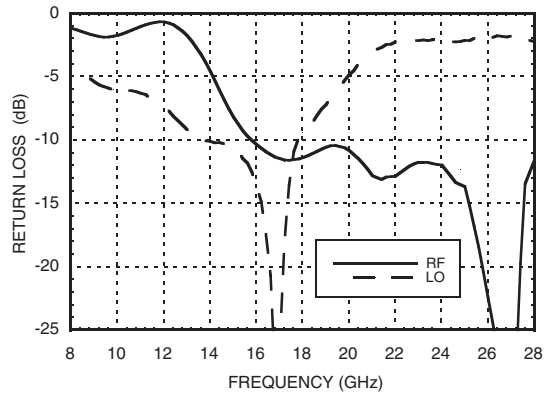

Input P1dB vs. Temperature

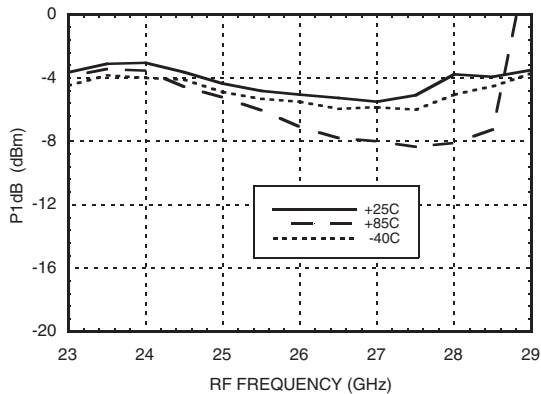

Input IP3 vs. LO Drive

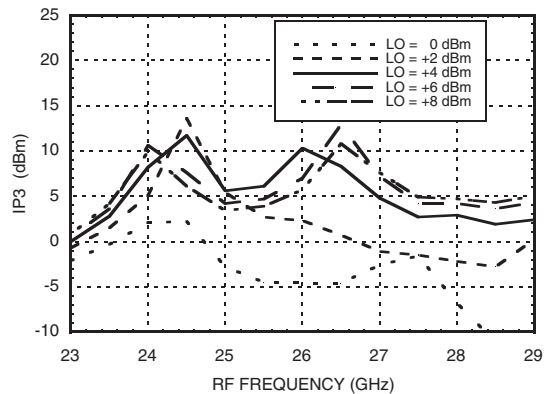



Quadrature Channel Data Taken Without IF Hybrid

Isolations

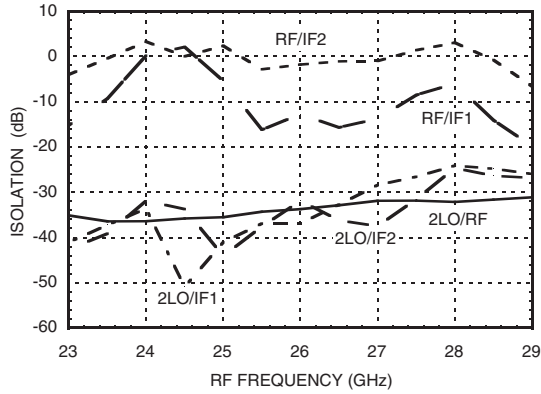

IF Bandwidth*

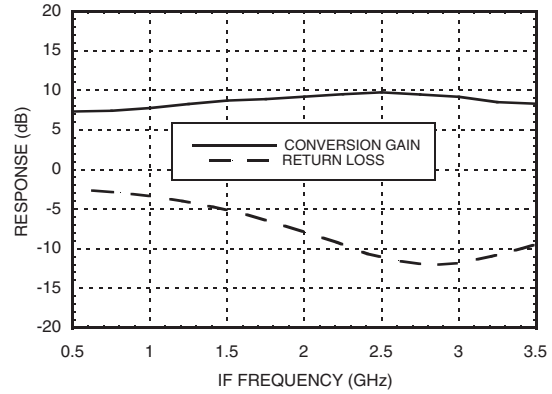

Amplitude Balance vs. LO Drive

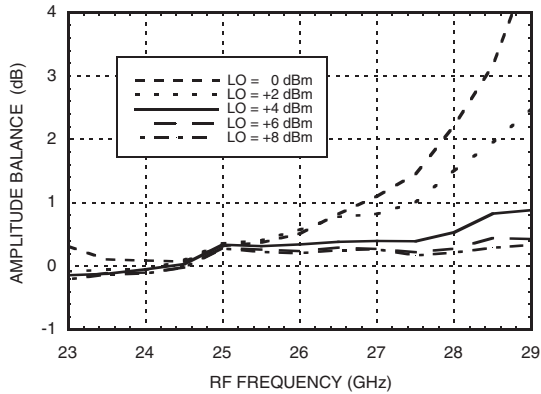

Phase Balance vs. LO Drive

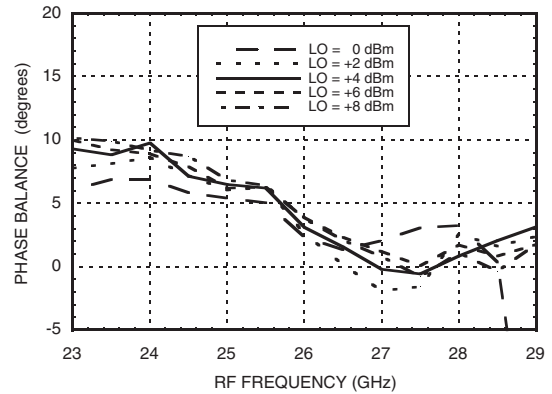

Noise Figure vs. LO Drive, LO Frequency = 12 GHz

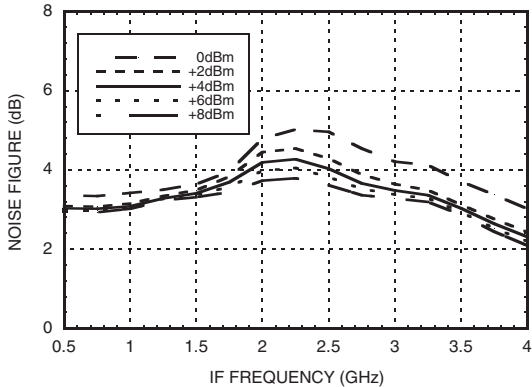

Noise Figure vs. LO Drive, IF Frequency = 100 MHz

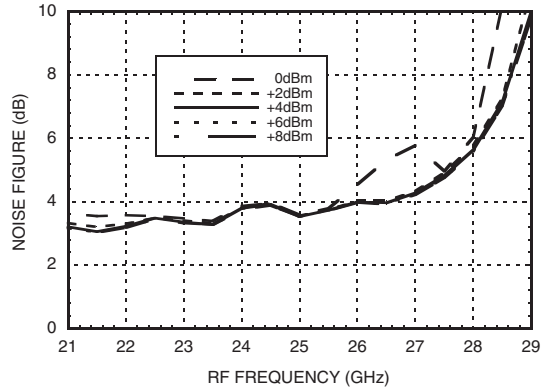

* Conversion gain data taken with external IF hybrid, LO frequency fixed at 12 GHz and RF varied

MxN Spurious Outputs

mRF	nLO				
	0	1	2	3	4
0	xx	37	12	32	45
1	12	41	0	37	41
2	xx	xx	66	70	46
3	xx	xx	xx	xx	79
4	xx	xx	xx	xx	xx

RF = 25 GHz @ -20 dBm
 LO = 12 GHz @ +4 dBm
 Data taken without IF hybrid
 All values in dBc below IF power level (1RF -2LO = 1 GHz)

Absolute Maximum Ratings

RF	+2 dBm
LO Drive	+ 13 dBm
Vdd	5.5V
Channel Temperature	175°C
Continuous P _{diss} (T=85°C) (derate 9.56 mW/°C above 85°C)	860 mW
Thermal Resistance (R _{TH}) (channel to package bottom)	104.6 °C/W
Storage Temperature	-65 to +150 °C
Operating Temperature	-55 to +85 °C
ESD Sensitivity (HBM)	Class 1B



**ELECTROSTATIC SENSITIVE DEVICE
OBSERVE HANDLING PRECAUTIONS**

Outline Drawing

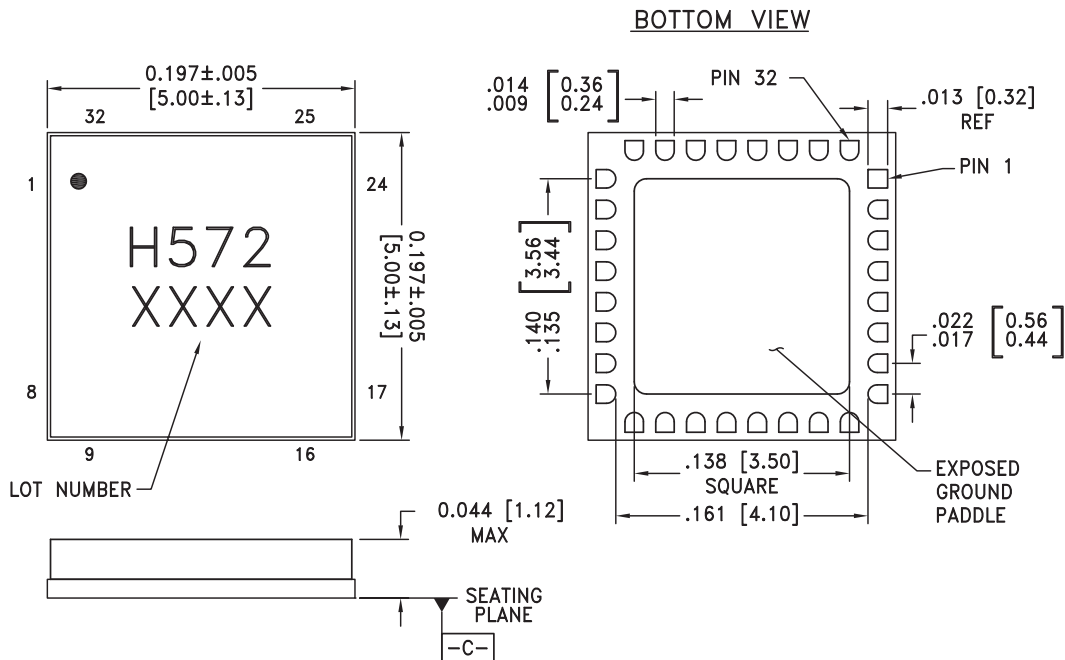

NOTES:

- PACKAGE BODY MATERIAL: ALUMINA
- LEAD AND GROUND PADDLE PLATING: 30 - 80 MICROINCHES GOLD OVER 50 MICROINCHES MINIMUM NICKLE
- DIMENSIONS ARE IN INCHES [MILLIMETERS]
- LEAD SPACING TOLERANCE IS NON-CUMULATIVE
- PACKAGE WARP SHALL NOT EXCEED 0.05mm DATUM
- ALL GROUND LEADS AND GROUND PADDLE MUST BE SOLDERED TO PCB RF GROUND

Pin Descriptions

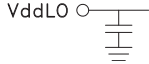
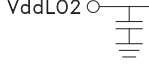
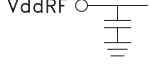
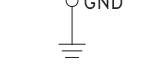
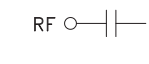
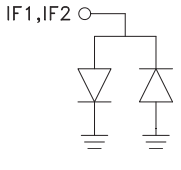
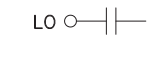
Pin Number	Function	Description	Interface Schematic
1	VddLO	Power supply for first stage of LO amplifier.	
2, 4 - 6, 8, 9, 12 - 18, 21, 22, 25 - 28, 31, 32	N/C	No connection required. These pins may be connected to RF/DC ground without affecting performance.	
3	VddLO2	Power supply for second stage of LO amplifier.	
7	VddRF	Power supply for RF LNA.	
10, 19, 24, 29	GND	These pins and ground paddle must be connected to RF/DC ground.	
11	RF	This pin is AC coupled and matched to 50 Ohms.	
20	IF2	This pin is DC coupled for applications not requiring operation to DC. This port should be DC blocked externally using a series capacitor whose value has been chosen to pass the necessary frequency range. For operation to DC, this pin must not sink / source more than 3 mA of current or part non-function and possible failure will result.	
23	IF1		
30	LO	This pin is AC coupled and matched to 50 Ohms.	

Typical Application

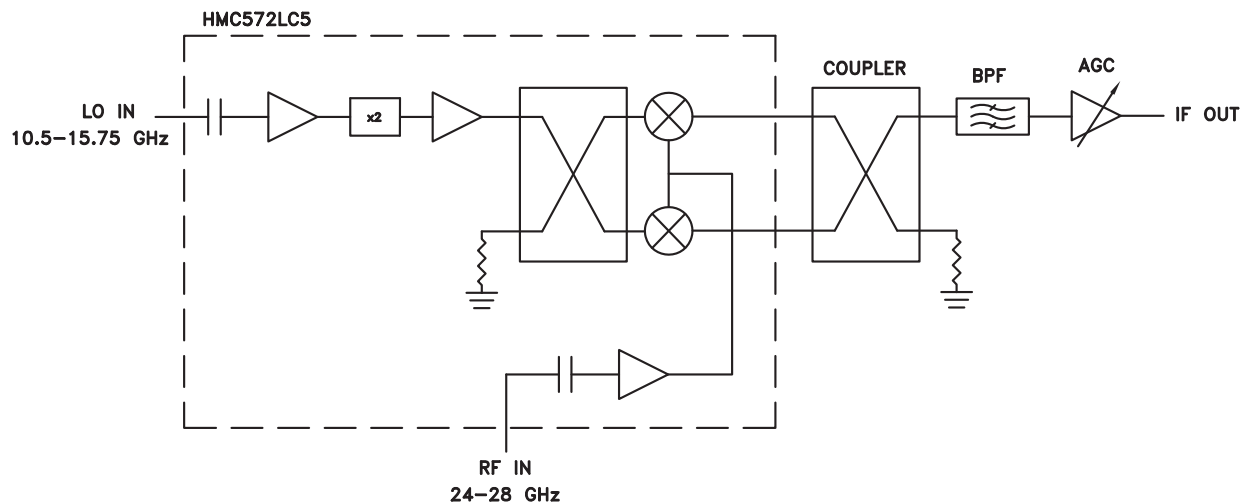

Evaluation PCB

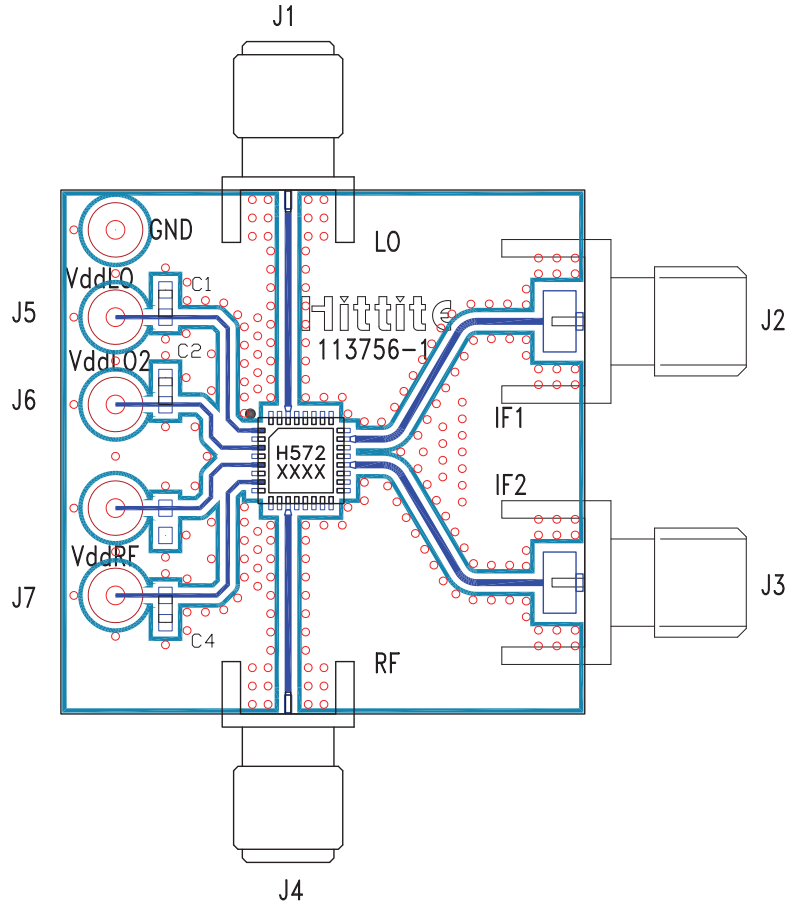

List of Materials for Evaluation PCB 113758 [1]

Item	Description
C1 - C4	Capacitor 0603, 0.01 μ F
J1, J4	PCB Mount SMA RF Connector, SRI
J2, J3	PCB Mount SMA Connector, Johnson
J5 - J7	DC Pin
U1	HMC572LC5
PCB [2]	113756 Evaluation Board

[1] Reference this number when ordering complete evaluation PCB

[2] Circuit Board Material: Rogers 4350

The circuit board used in the final application should use RF circuit design techniques. Signal lines should have 50 ohm impedance while the package ground leads and exposed paddle should be connected directly to the ground plane similar to that shown. A sufficient number of via holes should be used to connect the top and bottom ground planes. The evaluation circuit board shown is available from Hittite upon request.

Данный компонент на территории Российской Федерации

Вы можете приобрести в компании MosChip.

Для оперативного оформления запроса Вам необходимо перейти по данной ссылке:

<http://moschip.ru/get-element>

Вы можете разместить у нас заказ для любого Вашего проекта, будь то серийное производство или разработка единичного прибора.

В нашем ассортименте представлены ведущие мировые производители активных и пассивных электронных компонентов.

Нашей специализацией является поставка электронной компонентной базы двойного назначения, продукции таких производителей как XILINX, Intel (ex.ALTERA), Vicor, Microchip, Texas Instruments, Analog Devices, Mini-Circuits, Amphenol, Glenair.

Сотрудничество с глобальными дистрибьюторами электронных компонентов, предоставляет возможность заказывать и получать с международных складов практически любой перечень компонентов в оптимальные для Вас сроки.

На всех этапах разработки и производства наши партнеры могут получить квалифицированную поддержку опытных инженеров.

Система менеджмента качества компании отвечает требованиям в соответствии с ГОСТ Р ИСО 9001, ГОСТ РВ 0015-002 и ЭС РД 009

Офис по работе с юридическими лицами:

105318, г.Москва, ул.Щербаковская д.3, офис 1107, 1118, ДЦ «Щербаковский»

Телефон: +7 495 668-12-70 (многоканальный)

Факс: +7 495 668-12-70 (доб.304)

E-mail: info@moschip.ru

Skype отдела продаж:

moschip.ru

moschip.ru_4

moschip.ru_6

moschip.ru_9