

## Compact Power Line Shelves

### RS485 type shelves for the GP100 rectifier

Model: J2014001L4xx

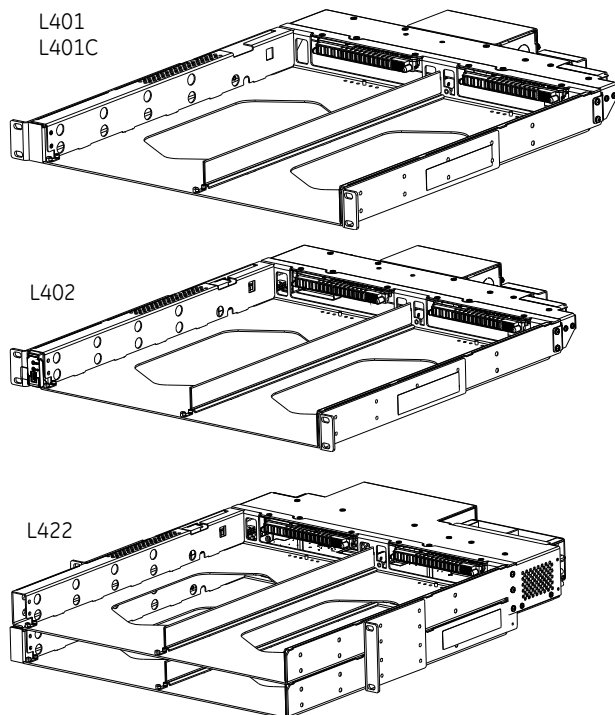

## Features

- Mounts into standard 19" EIA-310-D racks
- Terminal block AC connections
- -48Vdc output
- Adjustable mounting ears
- Supports hot-swapping of modules
- Mechanical latching slots
- RS485 based GE Galaxy Protocol
- Emergency Power OFF pin (Interlock)
- Passes Zone 4 earthquake requirements
- CUR\*† recognized
- CB report
- CE Mark§
- Shock & Vibration: Meets IPC 9562 Class II

## Description

This Preliminary Data Sheet documents the capabilities of shelves supporting the RS485 based interface. These shelves are designed for use with the GP100H3R48RE and associated family of rectifiers.

GE offers a comprehensive set of supporting components. A system controller is normally inserted into the first shelf. Normally, the system controller communicates using the GE Galaxy Protocol. The purpose of the controller is to maintain the functionality of the power system and inform/be-guided- by remote management controllers. Further information on the capabilities of these turn-key systems can be obtained from your GE Sales Representative

\* UL is a registered trademark of Underwriters Laboratories, Inc.

† CSA is a registered trademark of Canadian Standards Association.

§ This product is intended for integration into end-user equipment. All CE marking procedures of end-user equipment should be followed. (The CE mark is placed on selected products.)

\*\* ISO is a registered trademark of the International Organization of Standards

## Absolute Maximum Ratings

Stresses in excess of the absolute maximum ratings can cause permanent damage to the device. These are absolute stress ratings only, functional operation of the device is not implied at these or any other conditions in excess of those given in the operations sections of the data sheet. Exposure to absolute maximum ratings for extended periods can adversely affect the device reliability.

Parameter	Symbol	Min	Max	Unit
Input Voltage: Continuous	V <sub>IN</sub>	0	600	V <sub>AC</sub>
Operating Ambient Temperature	T <sub>A</sub>	-10	75 <sup>1</sup>	°C
Storage Temperature	T <sub>stg</sub>	-40	85	°C
I/O Isolation voltage to Frame (100% factory Hi-Pot tested)			2087	V <sub>AC</sub>

## Electrical Specifications

Unless otherwise indicated, specifications apply over all operating input voltage, load, and temperature conditions.

INPUT					
Parameter	Symbol	Min	Typ	Max	Unit
Operational Range	V <sub>IN</sub>	320	380/480	530	V <sub>AC</sub>
Frequency Range	F <sub>IN</sub>	47	50/60	63	Hz
AC Input Current, (3Φ - all phases operational)	I <sub>IN</sub>			15	A <sub>AC</sub>
Recommended AC Breaker Size			10 15		A <sub>AC</sub>
					@ 480V <sub>AC</sub> @ 380V <sub>AC</sub>
Leakage Current (per Φ, 530VAC, 60Hz)	I <sub>IN</sub>		2.5	3.5	mA
Isolation (per EN60950)	V	3000 2000			V <sub>AC</sub> V <sub>AC</sub>
					Input - Output Input-Chassis/Signals

MAIN OUTPUT					
Parameter	Symbol	Min	Typ	Max	Unit
Output Power	W	0	-	12,000	W
Max output current	I <sub>OUT</sub>			250	A <sub>DC</sub>
Isolation Output/frame - other circuits	V	100			V <sub>DC</sub>

## General Specifications

Parameter	Min	Typ	Max	Units	Notes
Reliability		TBD		Hrs	Full load, 25°C ; MTBF per SR232 Reliability protection for electronic equipment, issue 2, method I, case III,
Unpacked Weight				Kgs/Lbs	
Packed Weight		TBD		Kgs/Lbs	
Safety/Standards Compliance					
Safety Standards	UL60950-1, CAN/CSA C22.2 No 60950-1, EN60950-1				
Certification Marks	CE mark, UL Recognized (Canada and U.S.)				

<sup>1</sup> See the derating guidelines published in the rectifier data sheet

Compact Power Line Shelves  
**RS485 type shelves for the GP100 rectifier**  
 Model: J2014001L4xx

**Environmental Specifications**

Parameter	Min	Typ	Max	Units	Notes
Ambient Temperature	Operating	-10	55	°C	
	Storage	-40	85	°C	
Humidity	5		95	%	Relative humidity, non-condensing
Shock and Vibration acceleration			6	Grms	NEBS GR-63-CORE, Level 3, 20 -2000Hz, min 30 minutes
Earthquake Rating	4			Zone	NEBS GR-63-CORE, all floors, Seismic Zone 4 Designed and tested to meet NEBS specifications.

**Interfacing the L401, L401C shelves**

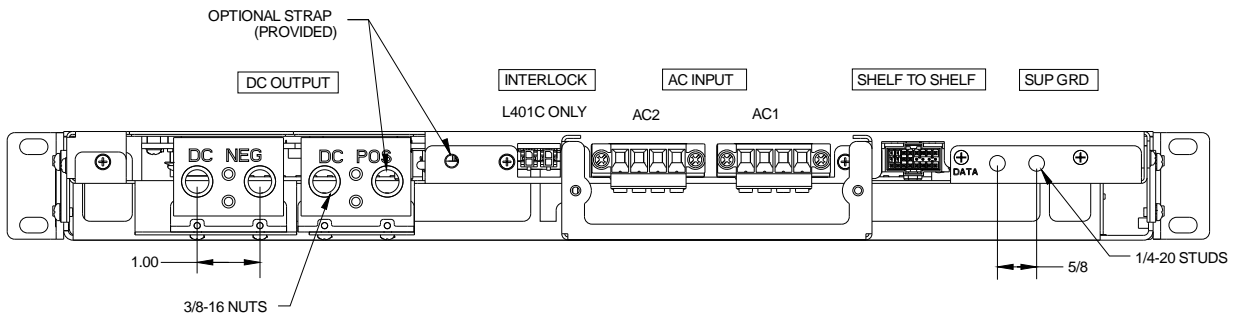

TORQUE : 240 IN-LBS  
 BOLTING HARDWARE PROVIDED

**Input (L401 and L402)**

Wire size: 16 – 10 AWG Torque: 7 IN-LBS Min strip length: 3/8 inch		
--	--	--

**Interlock (L401C only)**

Shelf connector: Molex 43020-0200,  
 suggested mate: Molex 43025-0200

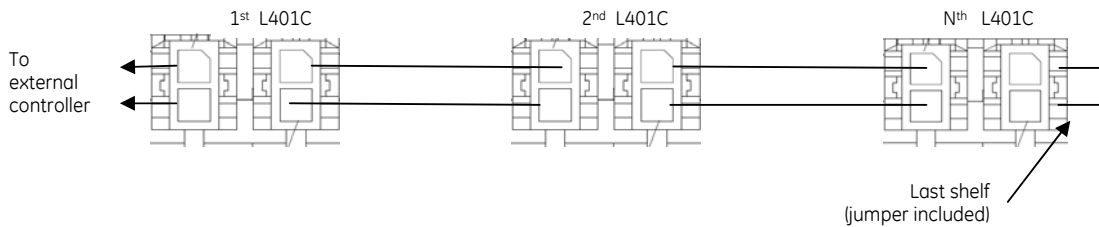

Compact Power Line Shelves  
**RS485 type shelves for the GP100 rectifier**

Model: J2014001L4xx

**Shelf-to-shelf (L401 and L402)**

Note: Shelf 1 is a L402 shelf with a system controller slot. Jumpers between pins 22-23 are included only on this shelf

Pin	Signal
1, 3	rsvd
4, 6	rsvd
7, 9	Bay addr
10, 12	RS485+
13, 15	RS485-
16, 18	L_GND
19, 21	rsvd
22	SHID_A
23	F_VB-
24	SHID_C

SHELF TO SHELF  
 CABLE 85003254  
 (PROVIDED FOR 1U SHELF SPACING )  
 OTHERWISE 1-1 CABLE  
 8 PIN CONECTOR ( 1 ROW )  
 MOLEX  
 HOUSING 50-57-0408  
 CONTACT 16-02-0086

CONNECT  
 SHELF 1  
 PINS 3, 6, 9, 12, 15, 18, 21, 24  
 TO  
 SHELF 2 (REMOVE JUMPERS)  
 PINS 1, 4, 7, 10, 13, 16, 19, 22

REMOVE JUMPERS

SHELF 1 ( TOP MOST SHELF )  
 SHELF 2 ( L401 STYLE )

Compact Power Line Shelves  
**RS485 type shelves for the GP100 rectifier**  
 Model: J2014001L4xx

**Interfacing the L402 shelf**

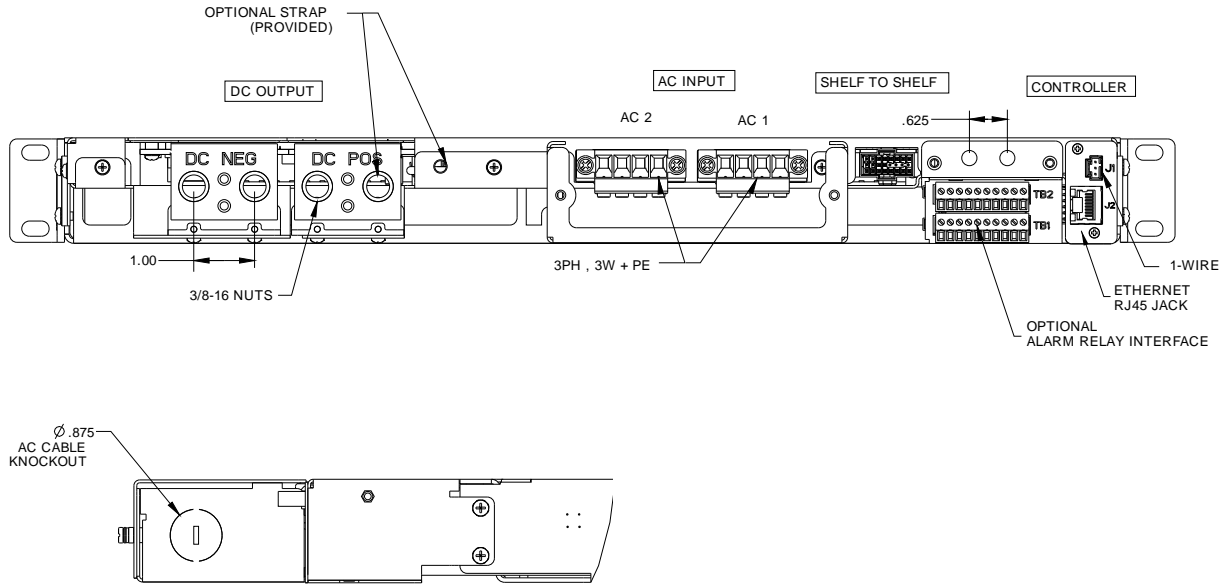

**Shelf-to-shelf (L402 initialization jumper)**

Pin	Label
1, 3	rsvd
4, 6	rsvd
7, 9	Bay addr
10, 12	RS485+
13, 15	RS485-
16, 18	L_GND
19, 21	rsvd
22	SHID_A
23	F_VB-
24	SHID_C

Jumper between 22-23 1<sup>st</sup> shelf only

Shelf\_ID components (all shelves)

**1-wire and Ethernet**

Pin	Signal
1	VB-
2	
3	RS485-
4	
5	VB+
6	
7	RS485+
8	L_GND

Pin	Signal
1	1-wire
2	GND
3	5V

Compact Power Line Shelves  
**RS485 type shelves for the GP100 rectifier**  
 Model: J2014001L4xx

**Optional Alarm Relay Interface (J2014001L000A)**

The Relay interface is orderable directly from the factory, or it can be installed as an assembly. The interface plugs into the side of the controller extension board and gets secured by two retention screws as shown below. The pin assignment in the tables below corresponds to the controller listed in the accessories section. The function of these signals can change when other controllers are used.

There are a total of 6 output relay contacts, labeled ALM1 through ALM6, accessible via this controller. Functional assignment is documented in the controller manual. The return for relay 6 is through ALM1C, the return for relay 1.

FBAT is available to interface a battery through an internal PTC to the output (-48V) bus.

BALM3 –BALM6 are connected internally through a resistor and an opto-isolator from each pin to power return. They can be used to monitor 4 independent battery positions.

For further information review the CC848836981 controller manual.

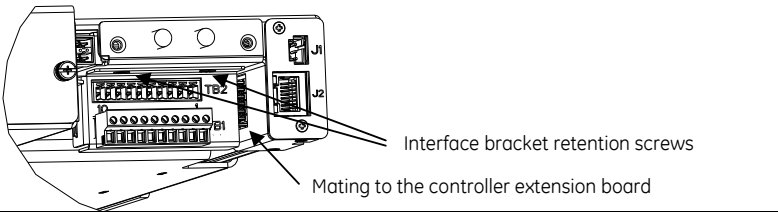
<p>No. of relays: 6                  Relay contacts 60V, 0.5A max                  Wire size 28 – 16 AWG                  Torque 2 in-lb                  Strip length 5/16"</p> <p>Relay interface retention screws:</p>																																													
<table border="1"> <thead> <tr> <th>Pin</th> <th>Signal</th> </tr> </thead> <tbody> <tr><td>TB1-1</td><td>ALM1</td></tr> <tr><td>TB1-2</td><td>ALM2</td></tr> <tr><td>TB1-3</td><td>ALM3</td></tr> <tr><td>TB1-4</td><td>ALM4</td></tr> <tr><td>TB1-5</td><td>ALM5</td></tr> <tr><td>TB1-6</td><td>ALM1C</td></tr> <tr><td>TB1-7</td><td>ALM2C</td></tr> <tr><td>TB1-8</td><td>ALM3C</td></tr> <tr><td>TB1-9</td><td>ALM4C</td></tr> <tr><td>TB1-10</td><td>ALM5C</td></tr> </tbody> </table>	Pin	Signal	TB1-1	ALM1	TB1-2	ALM2	TB1-3	ALM3	TB1-4	ALM4	TB1-5	ALM5	TB1-6	ALM1C	TB1-7	ALM2C	TB1-8	ALM3C	TB1-9	ALM4C	TB1-10	ALM5C	<table border="1"> <thead> <tr> <th>Pin</th> <th>Signal</th> </tr> </thead> <tbody> <tr><td>TB2-1</td><td>BALM6</td></tr> <tr><td>TB2-2</td><td>No connect</td></tr> <tr><td>TB2-3</td><td>BALM3</td></tr> <tr><td>TB2-4</td><td>BALM4</td></tr> <tr><td>TB2-5</td><td>BALM5</td></tr> <tr><td>TB2-6</td><td>FBAT</td></tr> <tr><td>TB2-7</td><td>FBAT</td></tr> <tr><td>TB2-8</td><td>FBAT</td></tr> <tr><td>TB2-9</td><td>ALM6</td></tr> <tr><td>TB2-10</td><td>ALM1C</td></tr> </tbody> </table>	Pin	Signal	TB2-1	BALM6	TB2-2	No connect	TB2-3	BALM3	TB2-4	BALM4	TB2-5	BALM5	TB2-6	FBAT	TB2-7	FBAT	TB2-8	FBAT	TB2-9	ALM6	TB2-10	ALM1C
Pin	Signal																																												
TB1-1	ALM1																																												
TB1-2	ALM2																																												
TB1-3	ALM3																																												
TB1-4	ALM4																																												
TB1-5	ALM5																																												
TB1-6	ALM1C																																												
TB1-7	ALM2C																																												
TB1-8	ALM3C																																												
TB1-9	ALM4C																																												
TB1-10	ALM5C																																												
Pin	Signal																																												
TB2-1	BALM6																																												
TB2-2	No connect																																												
TB2-3	BALM3																																												
TB2-4	BALM4																																												
TB2-5	BALM5																																												
TB2-6	FBAT																																												
TB2-7	FBAT																																												
TB2-8	FBAT																																												
TB2-9	ALM6																																												
TB2-10	ALM1C																																												

**Controller**

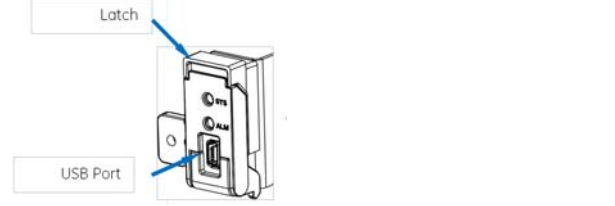
<p>The USB port on the front of the controller provides access to a remote controller that can be used to provide configuration information to the controller. Review the controller manual for further information.</p>	
--	--

## Rectifier Installation (all lists)

<p>Caution: The rectifier latch is not a carrying handle</p> <p>To release the latch press the dark gray area</p> <p>Slide in the rectifier while the latch is in the open position</p> <p>As resistance is felt when inserting, slowly close the latch to complete the insertion. When the latch is locked the rectifier is positively engaged in its housing.</p> <p>The rectifier can get extracted or inserted while the bus is hot.</p> <p>The rectifier is keyed to ensure that it gets inserted into the correct shelf. Do not force mating beyond normally anticipated resistance in order to avoid permanent damage.</p>	 <p>Latch release</p>
---	---

Compact Power Line Shelves  
**RS485 type shelves for the GP100 rectifier**  
 Model: J2014001L4xx

**Interfacing L422N shelf**

This shelf contains a L402 and a L401 shelf in a single enclosure. This enclosure cannot be expanded.

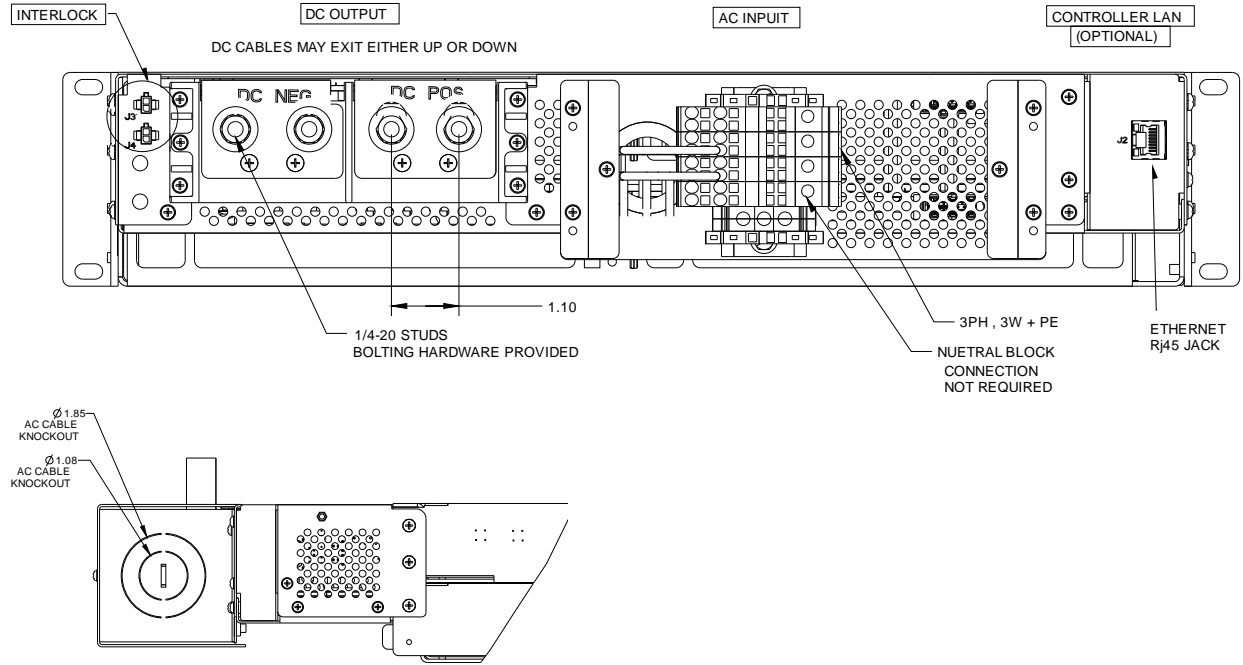

**Input (L401 and L402)**

<p>Wire size: 6 AWG max                  Torque: 15 IN-LBS                  Strip length: 3/8 inch</p>	
	<p>← The neutral conductor is not required</p> <p>← Frame ground terminations</p>



Compact Power Line Shelves  
**RS485 type shelves for the GP100 rectifier**

Model: J2014001L4xx

**Shelf keying**

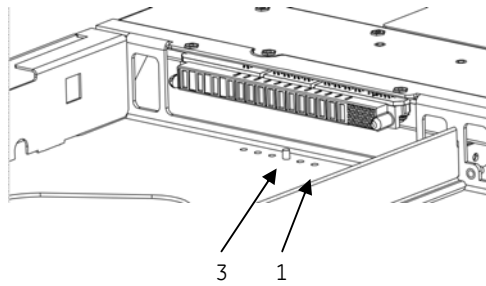

The key is a pin positioned in one of six holes on the bottom of the shelf

			One indicates slot opening					
Communication	Vin	Vout	1	2	3	4	5	6
RS-485	3Φ 480	48			1			
		380				1		
		250					1	
		125						1
I2C	3Φ 208	48		1				
		3Φ 480	48	1				

Below is a view of the rectifier slot filler configured for slot 3

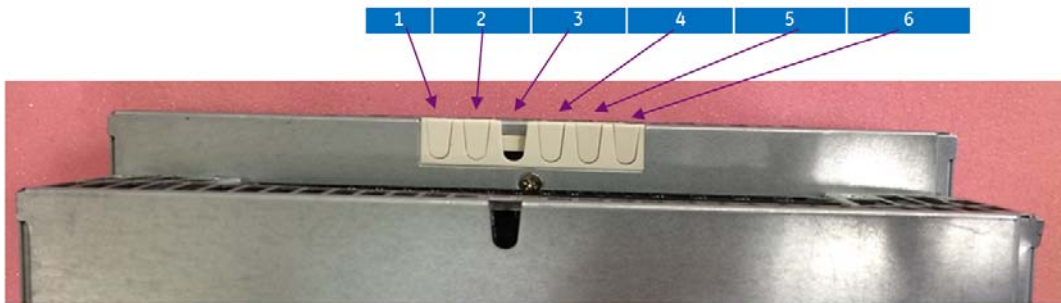

Compact Power Line Shelves  
RS485 type shelves for the GP100 rectifier  
Model: J2014001L4xx

### Package Outline

L401, L402

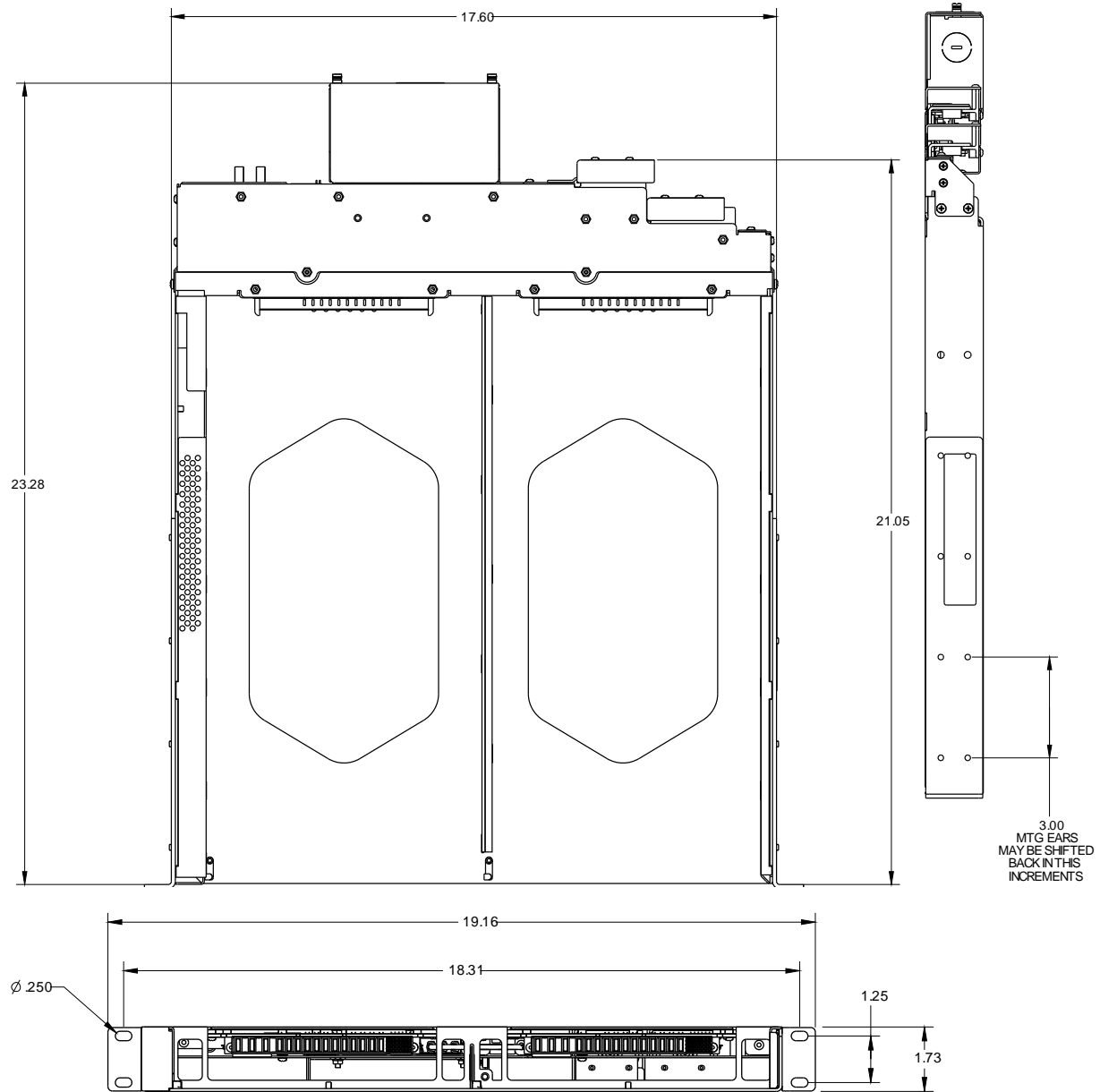

L422N

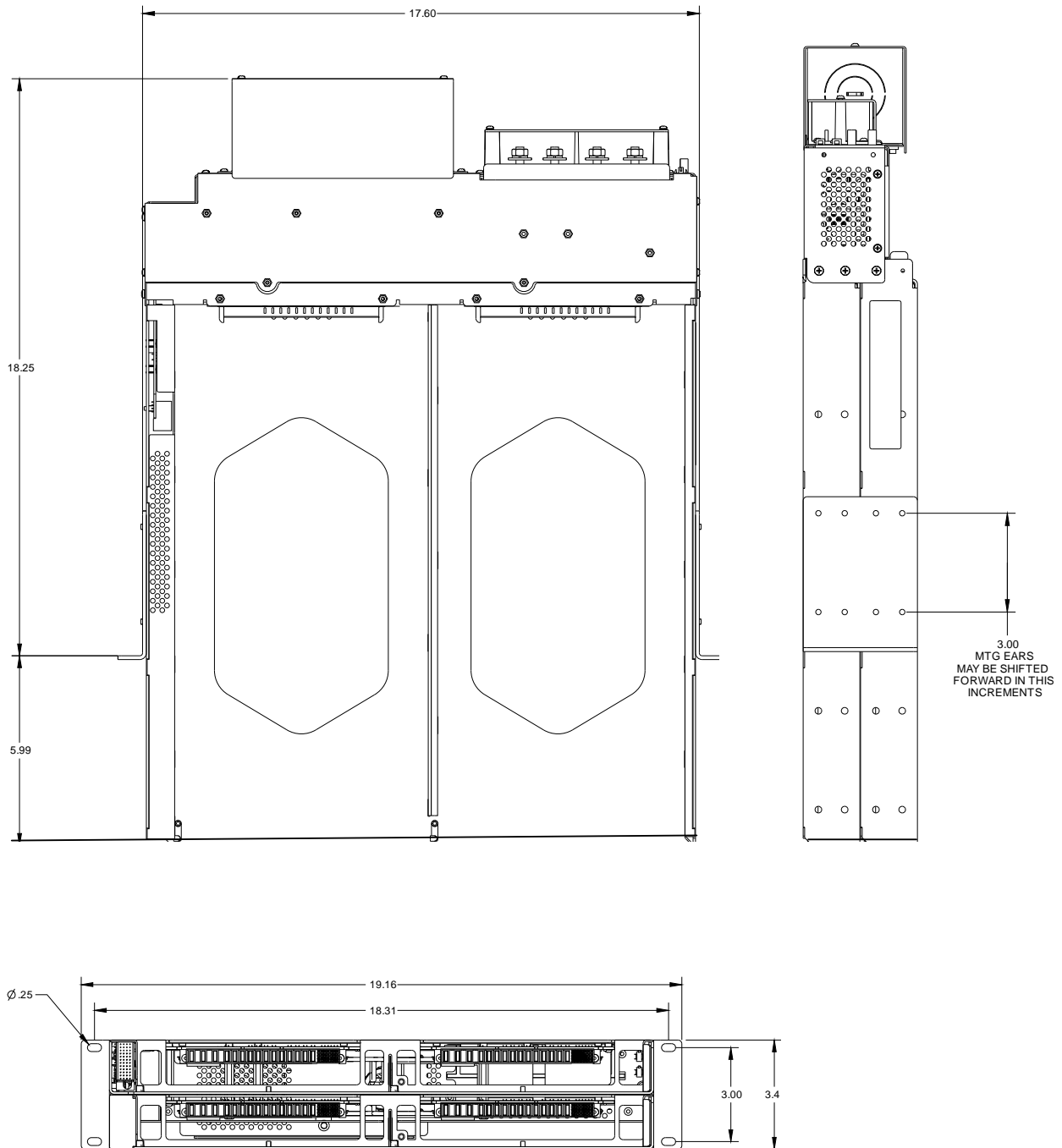

## Compact Power Line Shelves

**RS485 type shelves for the GP100 rectifier**

Model: J2014001L4xx

**Ordering Information**

Part Number	Description	Comcode
<b>Shelves</b>		
J2014001L401	GP100, 3Φ-480, RS485 communications, add-on /stand-alone shelf, configured for slot 3, hardware and shelf interconnect included	150041780
J2014001L402	GP100, 3Φ-480, RS485 communications, controller slot, LAN, RJ45 terminations, configured for slot 3	150041781
J2014001L402	GP100, 3Φ-480, RS485 communications, controller slot, LAN, RJ45 terminations, with L000A alarm relay interface, configured for slot 3, hardware and shelf interconnect included	150050125
J2014001L422N	GP100, 3Φ-480, RS485 communications, controller slot, RJ45 terminations, includes a L401 and a L402 shelves in the same enclosure. Hardware included	150048864
<b>Accessories</b>		
	GP100 Slot Filler	150045141
	Shelf-to-shelf interconnecting cable	850035254
	Alarm Relay Interface ( J2014001 L000A )	150050124
GCP841A_OI6R	Controller equipped with 6 output relays and a USB interface	150043558

## Compact Power Line Shelves

## RS485 type shelves for the GP100 rectifier

Model: J2014001L4xx

## Safety

### Product Labeling

Follow all warnings and instructions marked on the product. Some of the safety symbols used with the CP3500 rectifier and this shelf may include the following. They may also be accompanied by instructions:

#### **Mounting and Installation**

- This product shall be installed in compliance with mounting requirements for the ultimate application.
- This product must be installed, serviced, and operated only by skilled and qualified personnel who have the necessary knowledge and practical experience with electrical equipment and who understand the hazards that can arise when working on this type of equipment. This product is intended for use in a Restricted Access Location.
- This equipment is to be used in controlled environments (an area where the humidity is maintained at levels that cannot cause condensation on the equipment, the contaminating dust is controlled, and the steady-state ambient temperature is within the range specified).
- This equipment has been evaluated for use in a continuous ambient temperature of up to 55°C and the application environment should not exceed 55°C.
- The CE mark if provided on the product is applied to show conformance to the requirements outlined in the European Union's Low Voltage Directive {2006/95/EC} and EMC Directive {2004/108/EC}.
- This shelf has been evaluated for hot swapping.
- A separate protective Earthing terminal is provided at the rear of the shelf
  - the building installation shall provide a means for connection to protective earth; and
  - the equipment is to be connected to that means; and
  - a SERVICE PERSON shall check whether or not the socket-outlet from which the equipment is to be powered provides a connection to the building protective earth. If not, the SERVICE PERSON shall arrange for the installation of a PROTECTIVE EARTHING CONDUCTOR from the separate protective Earthing terminal to the protective earth wire in the building.

### Output Connections

- All field wiring should comply with the U.S. National Electrical Code (NEC) and/or applicable local codes/standards.
- Routing of the DC output cables should guarantee that cables are not in contact with sources of heat and surfaces that may damage the cable insulation.
- The DC output is not provided with a fuse or circuit breaker suitable for branch circuit protection. Therefore, the power shelf should be mounted in the same rack or cabinet as the equipment being powered. Use interconnecting power cables suitable for the application and sized to carry the rated output current. The interconnecting cables should be capable of carrying the overload current and short circuit current without damage or risk of fire.
- The output for the system is SELV and has available power greater than 240VA.
- Insulation on output field-wired conductors should be rated no less than 90°C. Wiring internal to enclosed equipment cabinets should be rated at 105°C (minimum). The provided DC output cords (red and black wires) are rated for 105°C.
- Before opening the insulating cover to gain access to load and ground connections, ensure all power supplies are disconnected from the AC MAINS.

### AC Input Connections

- This shelf is configured with primary internal wiring and Molex connectors, rated for internal factory wiring only. The Molex connector is not UL Recognized for direct connection to the AC mains. The internal wiring is not UL recognized to be directly accessible by a user. Consideration should be taken on the end product's Listing to comply with NEC requirement for AC mains installations.
- AC branch circuits to this equipment must be protected with fuses or circuit breakers sized as required by the U.S. National Electric Code (NEC) and/or local codes. Up to four AC mains power cords are required to power the shelf (one for each rectifier). Each power cord should be connected to a separate AC mains branch circuit with an overcurrent protector rated at no more than 30A.
- The power supply mains inlet may be used as the means to provide AC protective earthing.
- An accessible AC disconnect/protection device to remove AC power from the equipment in the event of an emergency must be provided. An accessible socket-outlet/receptacle installed near the equipment is also acceptable as a disconnect.
- The equipment is powered by multiple AC inputs (one per rectifier). Disconnect all AC sources of power before servicing.
- These units are to be used with TN-S power systems only.

## Safety Symbols and Guidelines

Read and understand all instructions before attempting any installation of this product. When installing, operating, or maintaining the J85480S1 Power System, basic safety precautions should always be followed to reduce the risk of fire, electric shock, and injury to persons. Such precautions include the following:



This symbol identifies the need to refer to the equipment instructions for important information.



This symbol identifies the presence of hazardous AC or DC voltages or hazardous energy levels. In the context of this product

- The DC output cables contain electrical energy levels capable of causing heating and arcing if shorted to metal objects. Make connections with the power disconnected.
- Hazardous AC voltage and DC electrical energy is contained within the enclosure of the power shelf. No user or field serviceable parts inside.



This symbol is used to identify safety earth ground connection points within the equipment.

## German Safety Guidelines

### Installationsanleitung

- Alle Ausgänge des Gerätes erfüllen die Anforderungen für SELV nach IEC/EN60950-1.
- Die Ausgänge des Gerätes liegen über den Limits für Energiegefahr nach IEC/EN60950-1 (>240 VA). Das Gerät ist zum Einbau in ein Montage-Rack bestimmt. Siehe Einbaubestimmungen in der Montageanleitung, um eine Gefährdung des Benutzers während der Installation zu vermeiden.

### ACHTUNG:

#### Hoher Ableitstrom Vor Anschluss an den Versorgungsstromkreis unbedingt Erdungsverbinding herstellen

- Das Produkt ist zum Gebrauch in einer Umgebungstemperatur von max. 55°C bestimmt.
- Die Gerätestecker des Produktes sind dazu bestimmt, eine sichere Erdung des Gerätes herzustellen.
- Das Produkt ist zum Gebrauch in einer Umgebung mit Verschmutzungsgrad 2 nach IEC/EN60950 bestimmt.
- Die Netzteile des Gerätes können während des Betriebes einzeln ausgetauscht werden (Hot Swapping).
- Das Gerät wurde zusammen mit den Anschlussleitungen (ohne Anschlussstecker) geprüft. Die Installation eines Steckers des jeweiligen Landes, sollte nur durch geschultes Service Personal durchgeführt werden. Als alternative könnte eine Vorinstallation des Steckers bereits bei der Herstellung erfolgt sein. Hungarian48ggs

## Contact Us

For more information, call us at

USA/Canada:

**+1 877 546 3243**, or +1 972 244 9288

Asia-Pacific:

+86.021.54279977\*808

Europe, Middle-East and Africa:

+49.89.878067-280

<http://www.geindustrial.com/products/critical-power>



imagination at work

GE Critical Power reserves the right to make changes to the product(s) or information contained herein without notice, and no liability is assumed as a result of their use or application. No rights under any patent accompany the sale of any such product(s) or information.

## Данный компонент на территории Российской Федерации

### Вы можете приобрести в компании MosChip.

Для оперативного оформления запроса Вам необходимо перейти по данной ссылке:

<http://moschip.ru/get-element>

Вы можете разместить у нас заказ для любого Вашего проекта, будь то серийное производство или разработка единичного прибора.

В нашем ассортименте представлены ведущие мировые производители активных и пассивных электронных компонентов.

Нашей специализацией является поставка электронной компонентной базы двойного назначения, продукции таких производителей как XILINX, Intel (ex.ALTERA), Vicor, Microchip, Texas Instruments, Analog Devices, Mini-Circuits, Amphenol, Glenair.

Сотрудничество с глобальными дистрибьюторами электронных компонентов, предоставляет возможность заказывать и получать с международных складов практически любой перечень компонентов в оптимальные для Вас сроки.

На всех этапах разработки и производства наши партнеры могут получить квалифицированную поддержку опытных инженеров.

Система менеджмента качества компании отвечает требованиям в соответствии с ГОСТ Р ИСО 9001, ГОСТ РВ 0015-002 и ЭС РД 009

### Офис по работе с юридическими лицами:

105318, г.Москва, ул.Щербаковская д.3, офис 1107, 1118, ДЦ «Щербаковский»

Телефон: +7 495 668-12-70 (многоканальный)

Факс: +7 495 668-12-70 (доб.304)

E-mail: [info@moschip.ru](mailto:info@moschip.ru)

Skype отдела продаж:

moschip.ru

moschip.ru\_4

moschip.ru\_6

moschip.ru\_9